

Note

In the event of complaints regarding noises from the front seats first determine whether the noise is caused by the seat cushion, backrest or seat adjustment mechanism. Perform these checks with the front seats **installed**. Before removing the seats also check the play in the reclining seat fitting by moving the backrest (figure) and note dimension "A".

Appropriate remedies are described in section "B".

The primary causes for noises and remedies for these are described below.

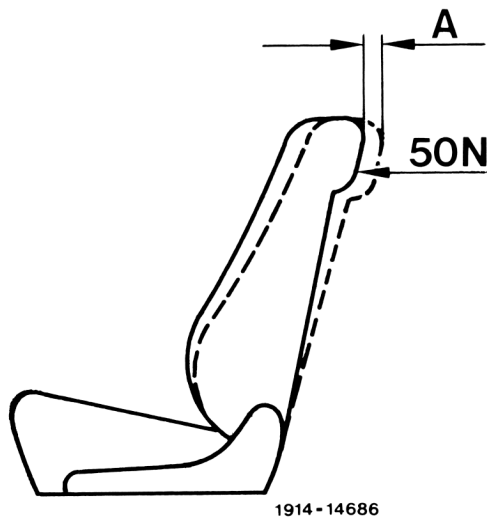

A. Seat cushion

1 On vehicles up to vehicle ident. end no. A 398050 or F 029367 replace seat cushion frame. For this purpose remove front seat and remove cover for seat cushion.

2 Remove all round wire clips and sew unbleached muslin cover to rubberized fiber matting with a number of stitches.

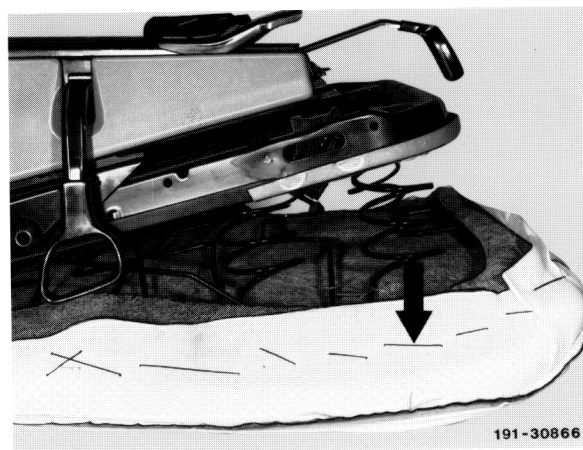

3 Hook seat cover in and install one additional clip 006 988 12 78 into the clip groove at the front and rear.

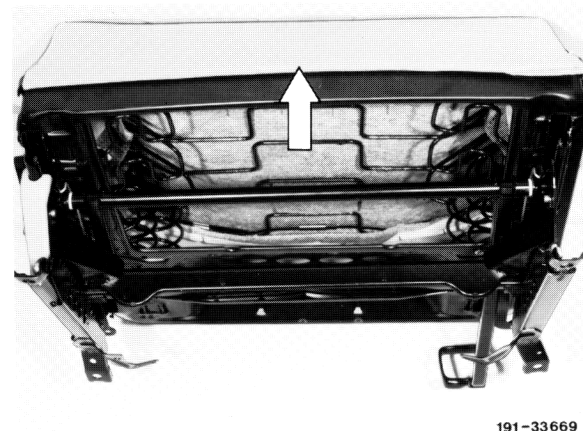

B. Front seat backrests

1 Replace backrest frame if the play in the reclining seat fitting is greater than 30 mm. If the play is less than 30 mm check whether the springs can be moved in relation to one another. If so replace the backrest frame in this case as well. For this purpose remove the front seat and take off the cover for the backrest frame (RI 91-182).

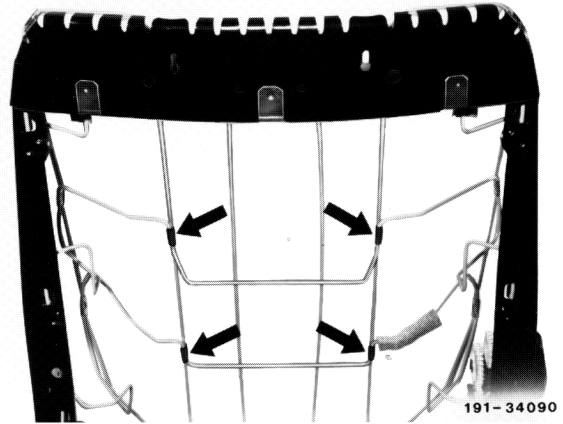

2 If the stop on the rubberized fiber matting rubs against the top of the backrest under load, replace rubberized fiber matting.



3 Cover both upper clips for retention in the longitudinal direction with large pieces of self-adhesive felt.

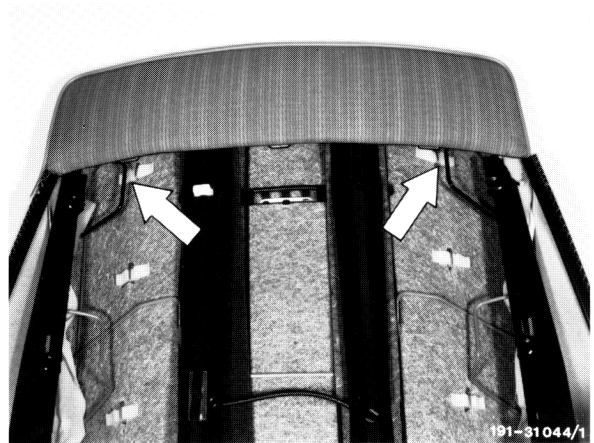

Additional causes of noise and remedies:

Cause

Backrest fitting rubs against backrest frame.

Remedy

Increase adjustment area or contact surfaces on inside and outside.

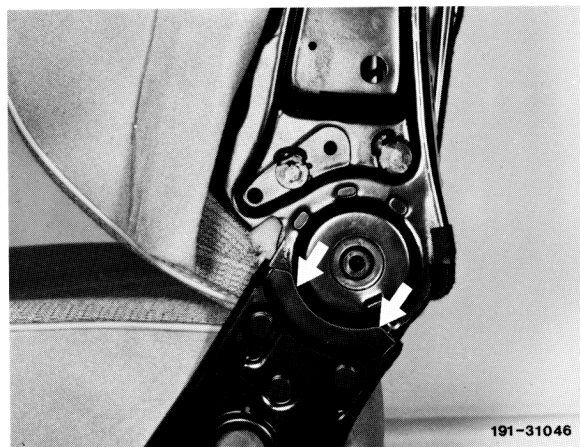

Cause

Guide rails for head restraints loose at bottom of backrest frame.

Remedy

Remove rivet and refasten with new rivet.

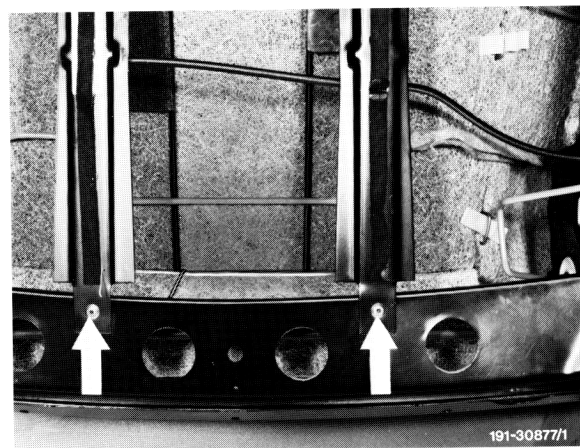

Cause

Top spring touches backrest frame at side.

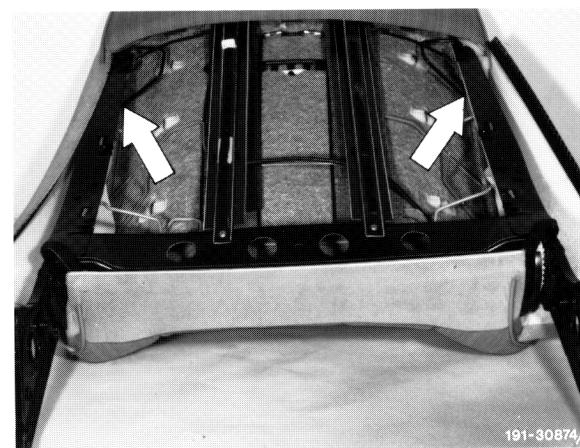

Remedy

Cover backrest frame in this area with self-adhesive felt.



Cause

Mounts for springs loose at side of backrest frame.

Remedy

Bend retaining lugs down tighter with screwdriver.



Cause

Clips at top of backrest frame (3 each) rub against tensioning element.

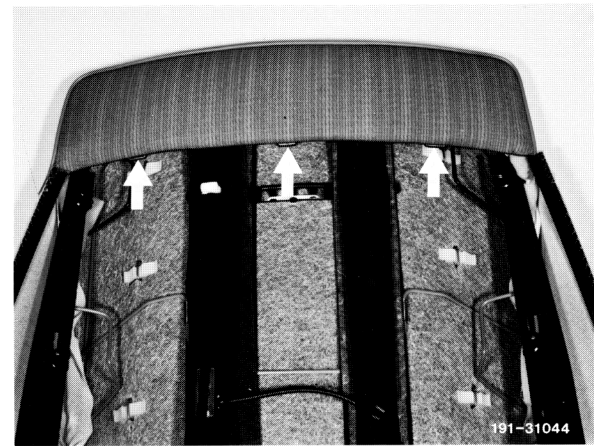

Remedy

Glue self-adhesive felt strips over clip groove on tensioning element.

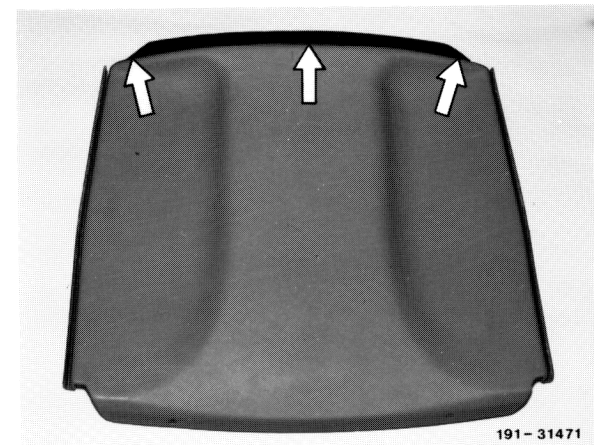

Cause

Piping on left and right rubs against tensioning element at top.



Remedy

Glue self-adhesive felt over corners (duct) on tensioning element.



Cause

Tensioning element rubs against backrest frame at bottom left and right.

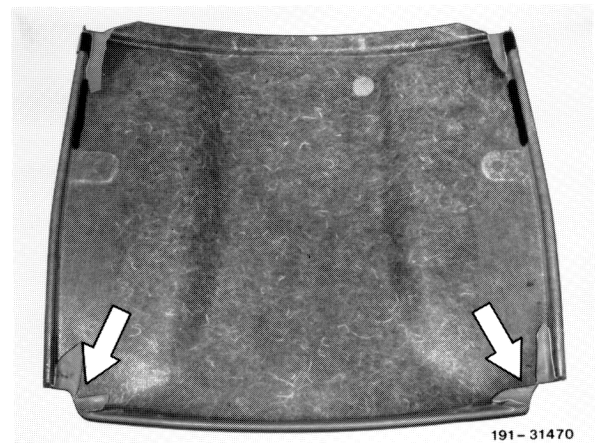

Remedy

Remove punching burr on backrest frame and cover with self-adhesive felt.

Note

When hooking the backrest cover in install an additional four clips 006 988 14 78 per backrest on the attachment strips and press into tensioning element.

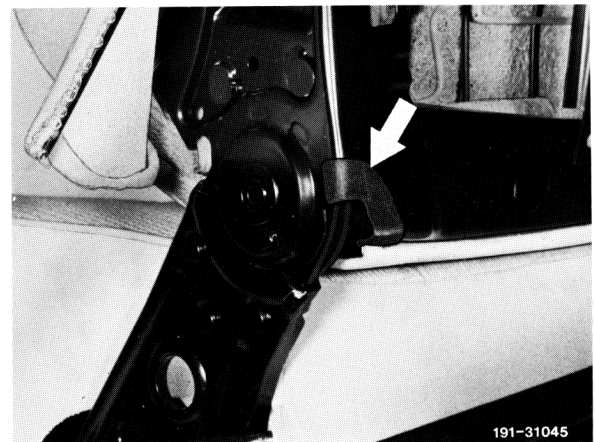

C. Seat adjustment mechanism

On all seat adjustment mechanisms with rivets of first version, drill out rivets and replace with nuts and bolts.

Seat adjustment mechanism, 1st version

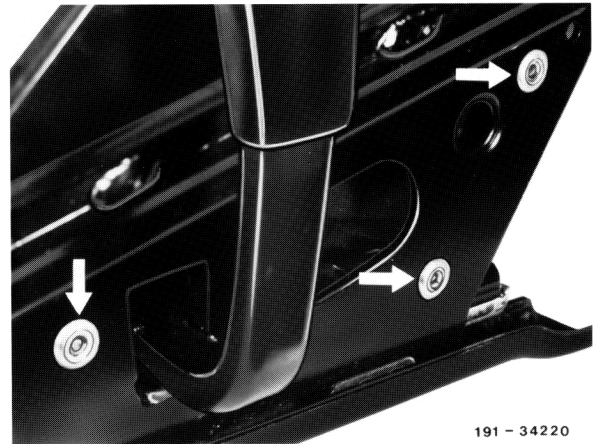

191 - 34220

Seat adjustment mechanism, 2nd version

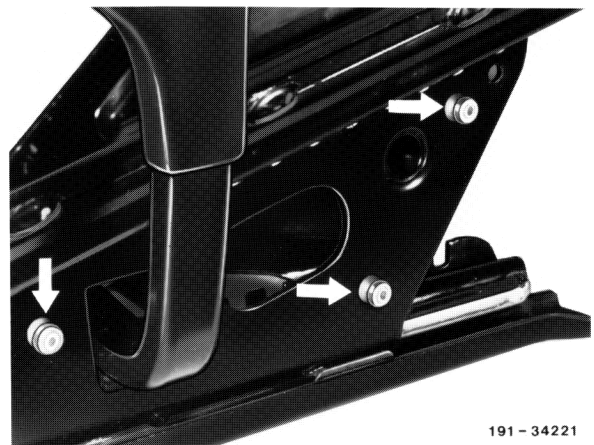

191 - 34221

When assembling the front seats also perform the following measures:

- 1 Grease guide sleeves in passage area of cushion frame.

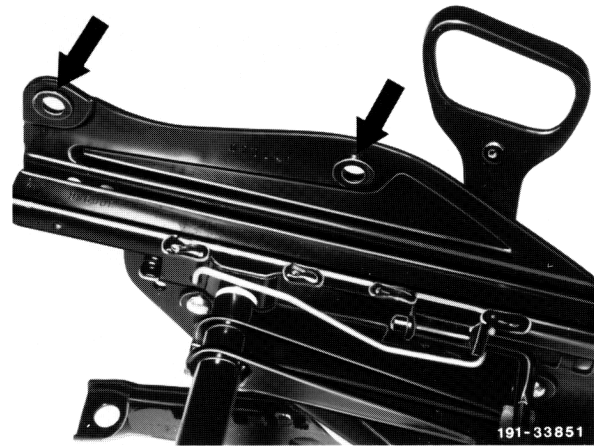

191 - 33851

2 Grease oblong holes and adjusting mechanism on inclination adjustment shaft.

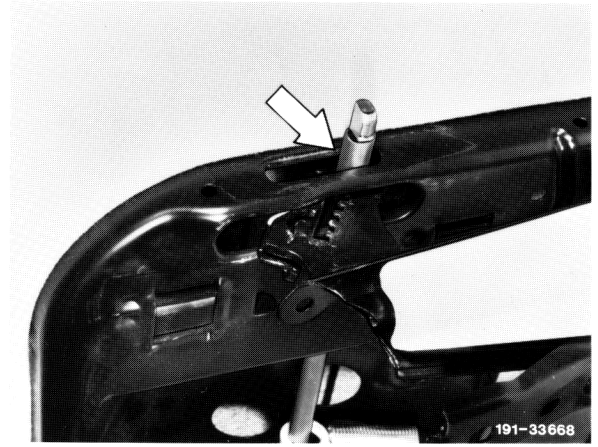

3 File down panelling on reclining seat fitting so that backrest cover cannot be damaged.

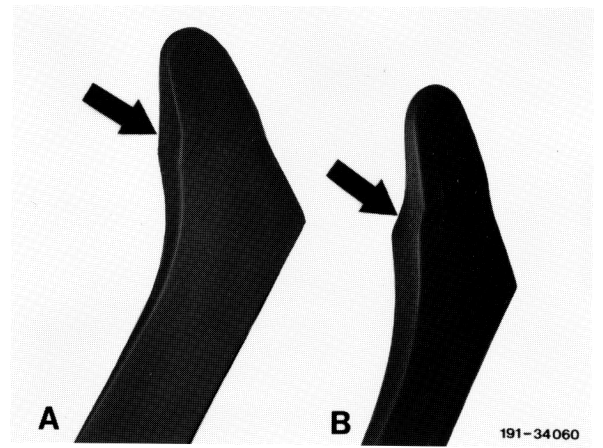

B Panel filed down