

P41-0003-57

P41-0003-57

- |   |   |
|---|---|
| Exhaust system (29) as of plug connection (connector) ..... | remove and install (49-100).  |
| Exhaust shielding plate (30) .....                          | screw off and on, 25 Nm (step 2).   |
| Transmission .....  | lift, support, lower.   |
| Engine carrier .....  | screw off and on, 45 Nm (step 4).   |
| Drive shaft gland nut (3) .....                             | loosen for approx. two turns.<br>Tightening torque 30 - 40 Nm,<br>open end wrench element 126 589 00 01 00<br>(step 6). |

## 41-050 R and R drive shaft

---

Front drive shaft (1) .....	<p>remove from and mount on transmission,  M 10 = 45 Nm,  M 12 = 65 Nm.</p> <p>On model 126.02 loosen fitted sleeve of flexible coupling with mandrel of 10 mm dia. Renew self-locking hex. nuts (14) (steps 7, 8).</p>
Rear drive shaft (2) .....	<p>remove from and mount on rear axle,  M 10 = 45 Nm,  M 12 = 65 Nm.</p> <p>Renew self-locking hex. nuts (26) (step 9).</p>
Drive shaft intermediate bearing (7) .....	<p>screw off and on. Tighten hex. head screws (7a) only after fastening drive shaft to transmission and rear axle, 25 Nm (step 10).</p>
Drive shaft, complete .....	<p>force off centering pin on transmission and rear axle and pull out toward the rear (step 11).</p>
Centering sleeves .....	<p>check for wear, with plastic or bronze bushings, grease cavities with Molykote grease and use multi-purpose grease with multi-component bushings (refer to factory approved service products list, quantity per sleeve approx. 6 g).</p>

### Special tools

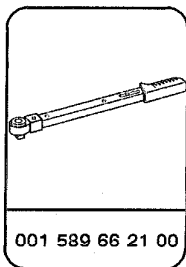
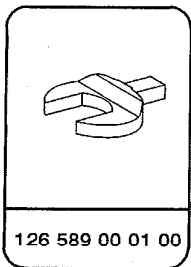

**Removal and Installation**

- 1 Remove exhaust system as of plug connection (49-100).

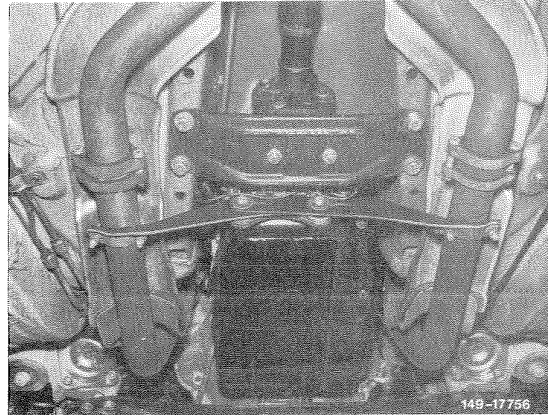

149-17756

- 2 Unscrew exhaust shielding plate.

**Installation note**

Tightening torque of hex. head screws or nuts  
25 Nm.

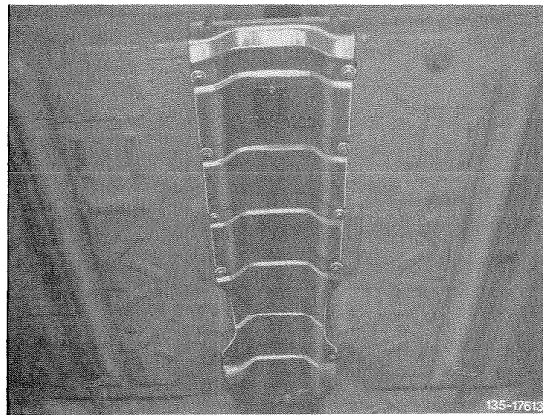

135-17613

- 3 Support transmission.
- 4 Unscrew hex. head screws of rear engine carrier from frame floor.

**Installation note**

Tightening torque 45 Nm.

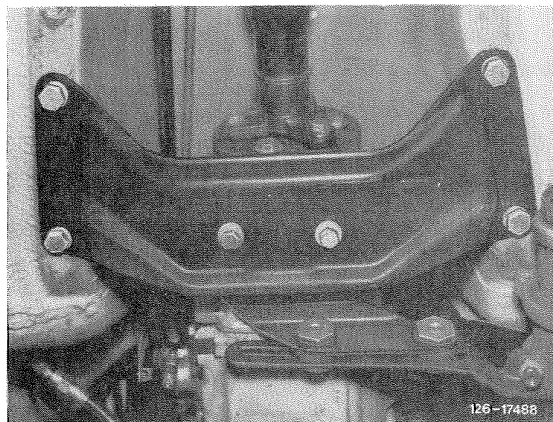

126-17488

## 41-050 R and R drive shaft

---

5 Unscrew hex. nut (arrow) and remove engine carrier.

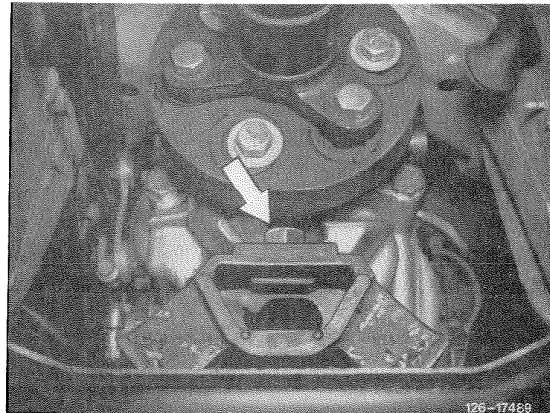

126-17489

6 Loosen drive shaft gland nut for approx. two turns without sliding back rubber sleeve (sliding along).  
Open-end wrench element 126 589 00 01 00.

### Installation note

Tightening torque 30 - 40 Nm, while paying attention to correct seat of rubber sleeve.

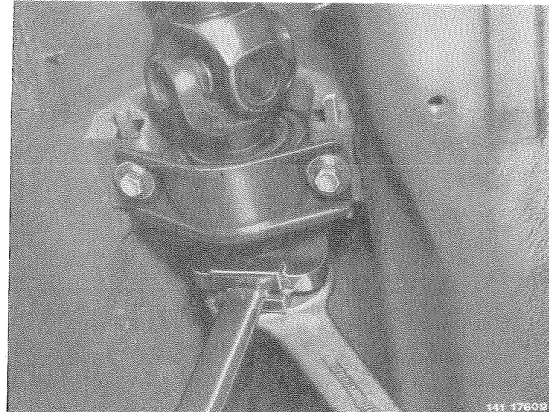

141-17608

7 Remove front drive shaft from transmission (arrows).

### Note

Flexible coupling remains on drive shaft.

### Installation note

Renew self-locking hex. nuts.

Tightening torque:    M 10 = 45 Nm,  
                              M 12 = 65 Nm.

Use washers with dimensions 10.5x25x1 (on models 126.02 only and on models 126.032/033 up to 08/80).

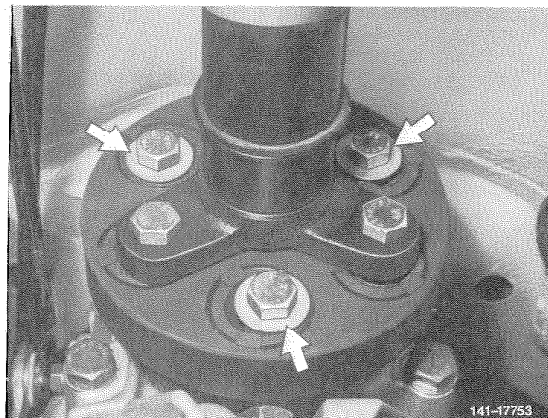

141-17753

8 On model 126.02 with radially or tangentially soft flexible couplings, loosen vulcanized fitted sleeves of flexible coupling prior to pushing back of drive shaft in flexible flange (arrows). For this purpose, use a cylindrical mandrel of 10 mm dia. and approx. 150 mm in length.

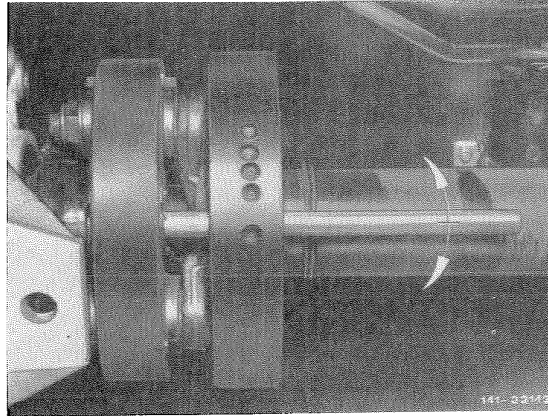

141-22143

9 Remove drive shaft from rear axle (arrows).

**Note**

Flexible coupling remains on drive shaft.

**Installation note**

Renew self-locking hex. nuts.

Tightening torque: M 10 = 45 Nm,  
M 12 = 65 Nm.

Use only washers with dimensions 10.5x25x1 (on models 126.02 only and on models 126.032/033 up to 08/80).

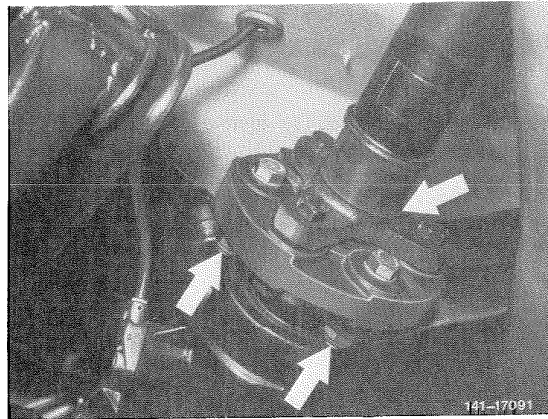

141-17091

**Installation note**

On the first vehicles (models 126.03/04 from 09 to 10/85) the three hex. head screws for fastening the flexible coupling to flexible flange must be mounted from the rear to the front for reasons of available space. The hex. head screws can be inserted only if the flexible flange is located at the level of the rear axle housing identified by an arrow.

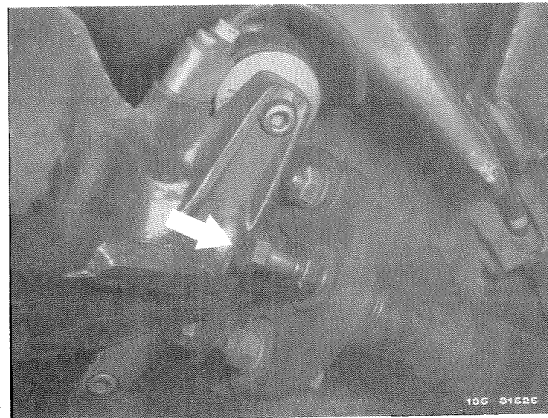

135-31525

## 41-050 R and R drive shaft

---

10 Unscrew hex. head screws (arrows) of drive shaft intermediate bearing on frame floor.

### Installation note

Tighten hex. head screws (arrows) only after fastening drive shaft to transmission and rear axle, tightening torque 25 Nm.



141-11955/1

11 Force drive shaft from centering pin on transmission and rear axle and remove in downward direction. Make sure that drive shaft will not be separated. On models 126.032/033 starting 09/80 and on models 126.036/037 remove drive shaft owing to larger flexible couplings of 110 mm dia. angularly through the welded-in cross member.

### ⚠ CAUTION!

If a separation of the drive shaft is required, mark these parts in relation to each other, since the drive shaft has been balanced in assembled condition.

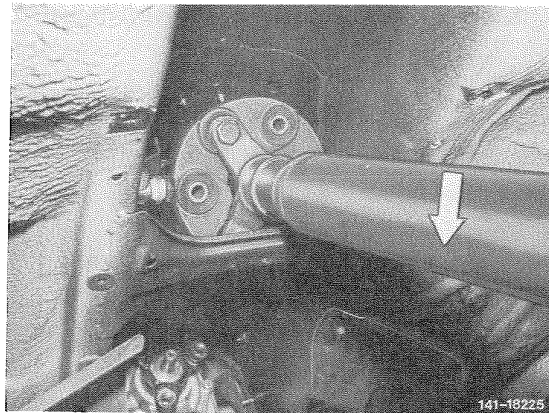

141-18225

12 All vehicles starting 08/82 carry an identification mark on front and rear drive shaft.

The front drive shaft is provided with a hump and the flexible fork of the rear drive shaft with two arrow-type humps (arrows). The hump of the front drive shaft should be located between the two arrows on the flexible fork (arrows).

### Note

Drive shafts on which the markings are not identical, should be marked in each case prior to removal.

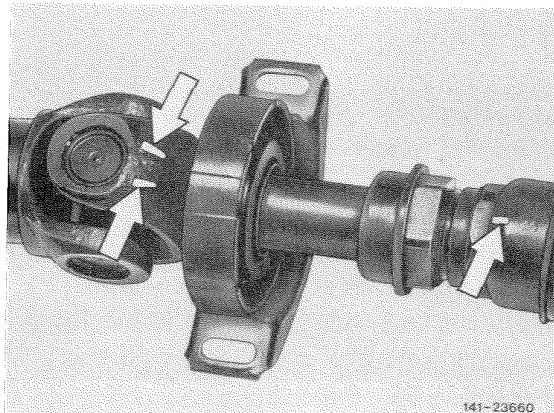

141-23660

13 Check flexible couplings, centering sleeves and drive shaft intermediate bearing for wear and renew parts if required.

14 A radially softer flexible coupling (B) is installed at transmission end on models 126.02. This version should be particularly checked for damage in range of fitted sleeves.

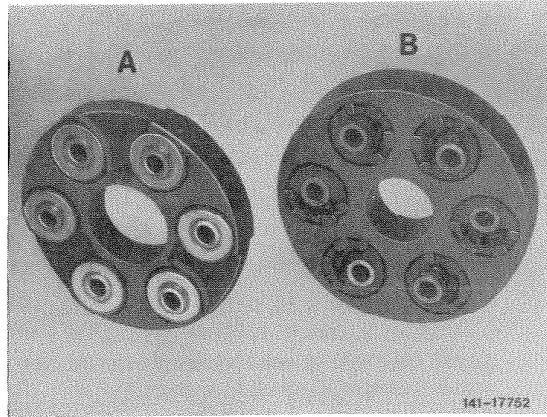

- A Flexible coupling at front and rear on models 126.03 with 110 mm bolt circle and at the rear on models 126.02 with 90 mm bolt circle.
- B Radially soft flexible coupling, at transmission end only on models 126.02 up to 08/85.

141-17752

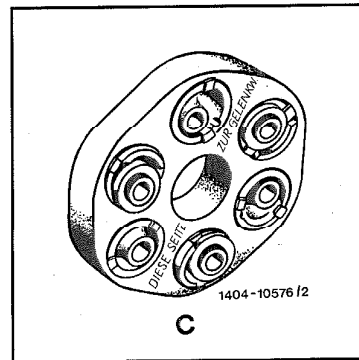

- C Soft pull-push flexible coupling, at transmission end only on models 126.02 starting 09/85.

1404-10576/2

15 Model 126.02 with manual 5-speed transmission. If the vibration damper is separated from drive shaft during replacement, mount vibration damper and three-legged flange as shown.

The installation position is correct, if the arrow of the vibration damper (20) points toward hump on three-legged flange.

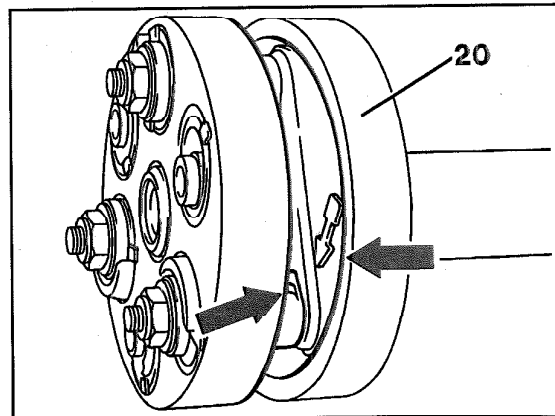

P41-2001-13

## 41-050 R and R drive shaft

16 With plastic or bronze bushings, grease cavities of both centering sleeves with Molykote grease and use multi-purpose grease with multi-component bearing bushings (refer to factory approved service products list, filling capacity per sleeve approx. 6 g).

17 For installation proceed vice versa.

Layout model 126.02 with 90 mm bolt circle dia. and vibration damper on vehicles with manual transmission.

- 1 Front drive shaft
- 10 Centering sleeve
- 11 Hex. head screw
- 12 Flexible coupling
- 12c Stop washers
- 13 Washer
- 14 Self-locking hex. nut
- 18 Universal flange
- 20 Vibration damper

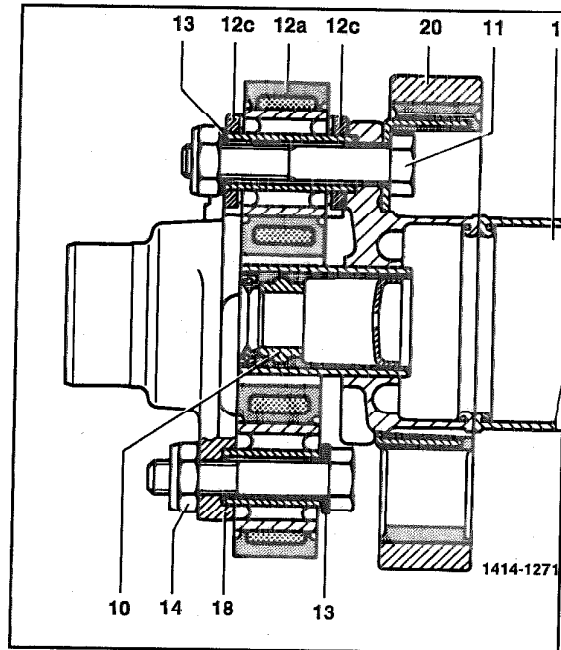

1414-12712

Layout model 126.03/04 with 110 mm bolt circle dia.

- 1 Front drive shaft
- 10 Centering sleeve
- 11 Hex. head screw
- 12 Flexible coupling
- 13 Washer
- 14 Self-locking hex. nut
- 18 Universal flange

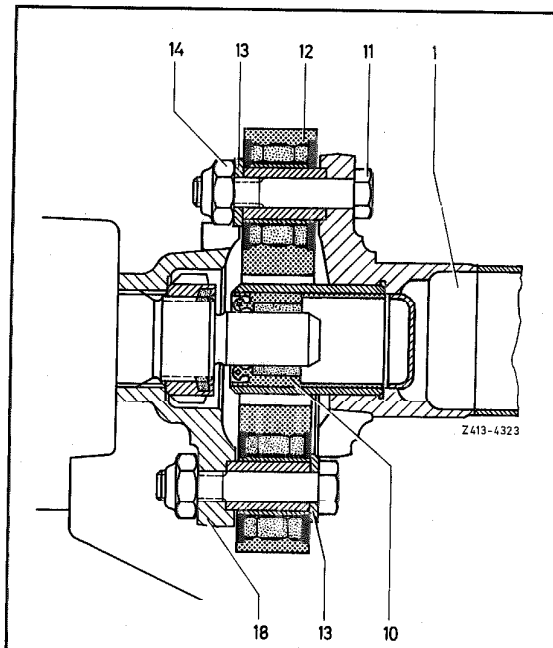

Z413-4323