

A. Removal and installation of venetian blind

Removal

- 1 Press out retaining clamps on left and right (arrow) with a screwdriver.

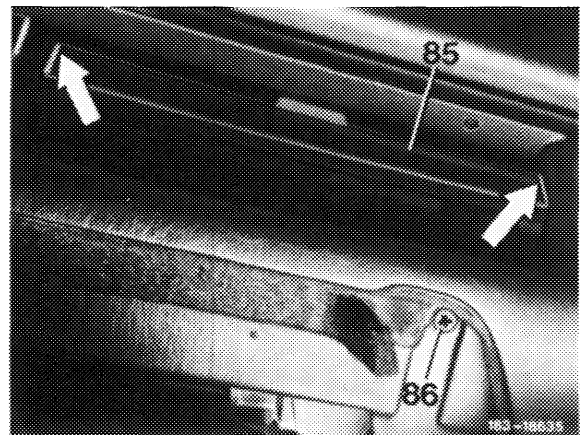

- 2 Turn venetian blind (85) downward and remove.

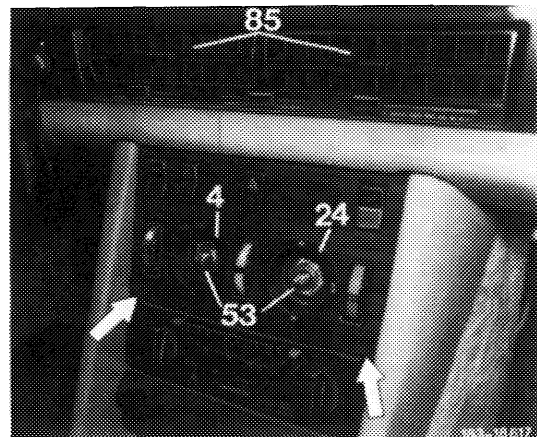

B. Removal and installation of frame

- 3 Remove glove box (68–140).
- 4 Disconnect battery terminals.
- 5 Remove instrument cluster (54–310).
- 6 Remove center console (68–200).
- 7 Carefully remove cover plate on bottom from housing (see arrow).

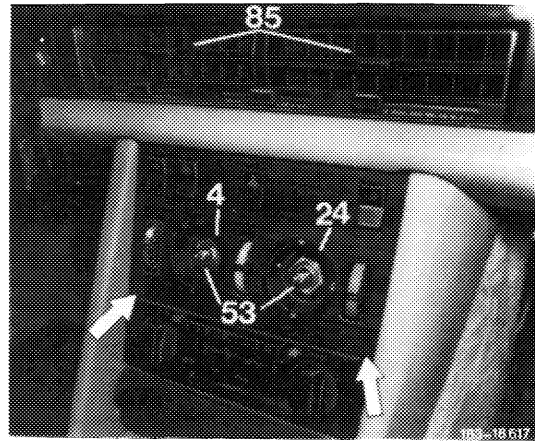

- 8 Remove screws (86).

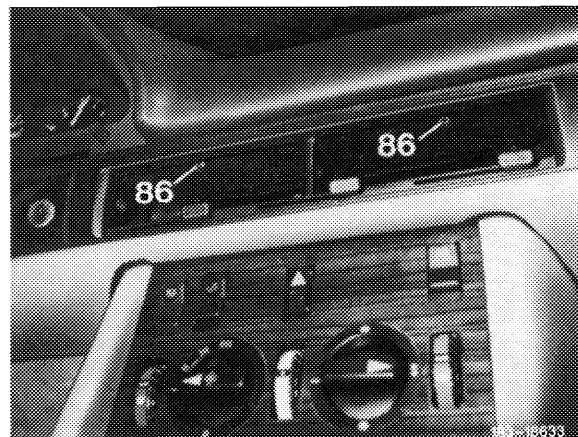
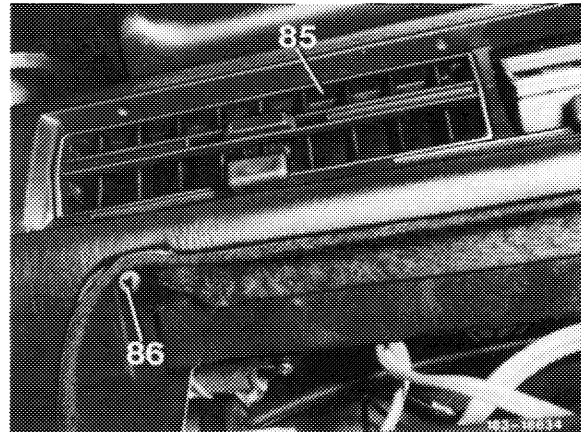
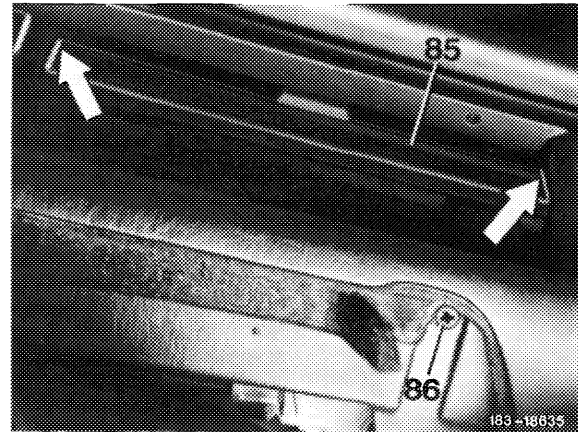

9 Detach Bowden cables (see arrow).

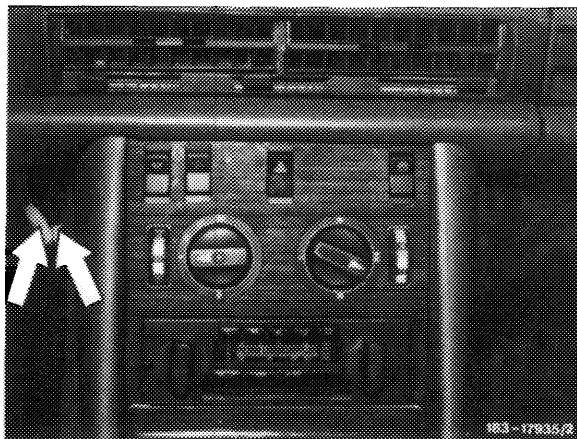

Attention!

Up to 06/82 the connecting rod is fastened to center nozzle flap with a separate spreading rivet. Starting 07/82 the spreading rivet is fastened to connecting rod.

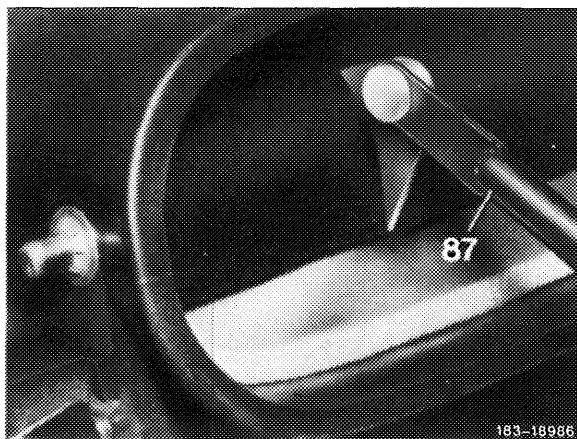

Fastening with spreading rivet up to 06/82

10 On version up to 06/82, reach through opening for glove box and instrument cluster while disconnecting connecting rod (87) and then lift out frame (88) with connecting hose toward the rear.

On version starting 07/82, loosen connecting rod (87) by unscrewing Phillips head screw (arrow) with swivelling venetian blind (85) installed.

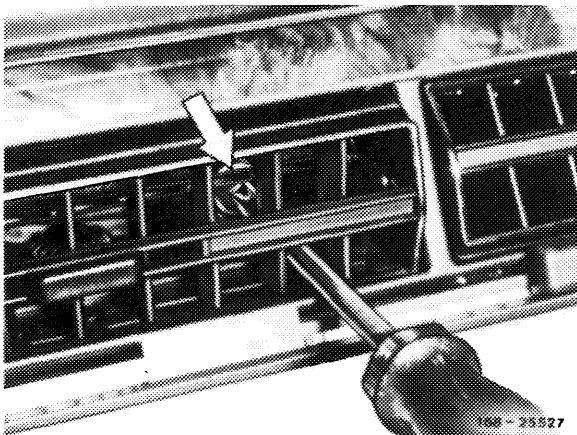

Fastening with screw starting 07/82

11 Remove clamp (90) with screwdriver and detach Bowden cables (see arrow).

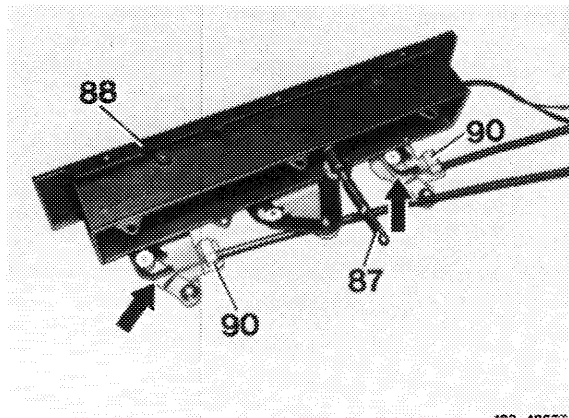

Installation

12 Install Bowden cables. Insert frame (88) with connecting hose through opening of glove box and insert connecting rod (87) (version up to 06/82) or fasten with Phillips head screw (version starting 07/82) (arrow) and adjust center nozzle flap. Make sure that the connecting hose is correctly seated.

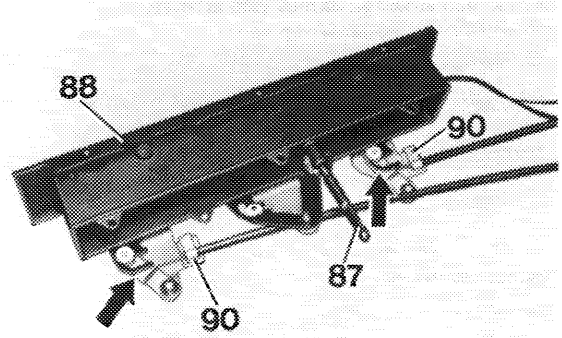

183-18637

Attention!

Up to 06/82, the connecting rod is fastened to center nozzle flap with a separate spreading rivet. Starting 07/82 the spreading rivet is fastened to connecting rod.

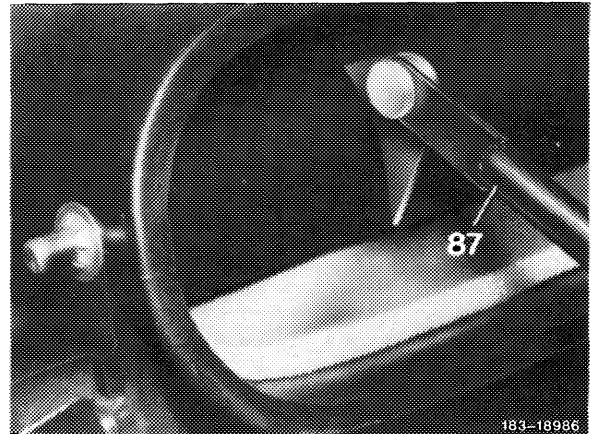

183-18986

Fastening with spreading rivet up to 06/82

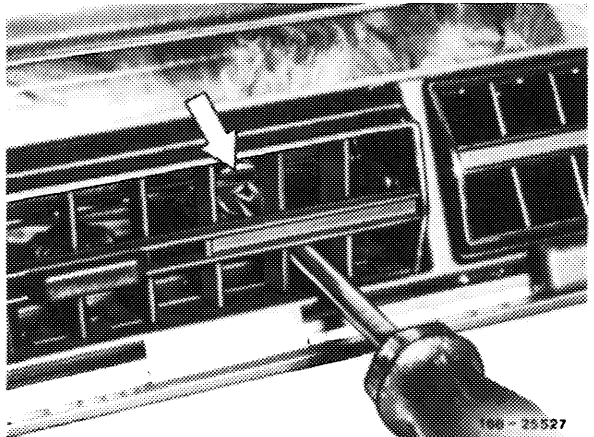

186-25327

Fastening with screw starting 07/82

13 Fit screws (86) and insert Venetian blinds (85) from the front.

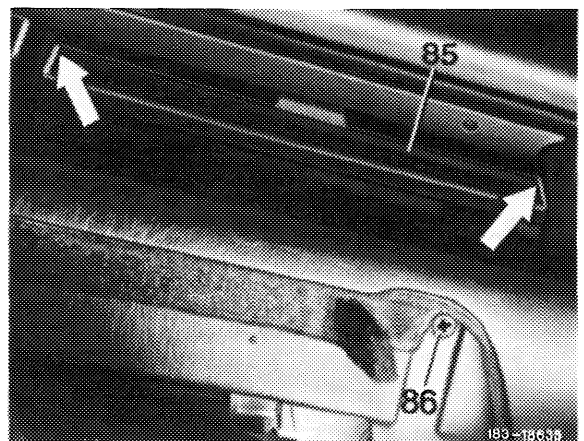

183-18533

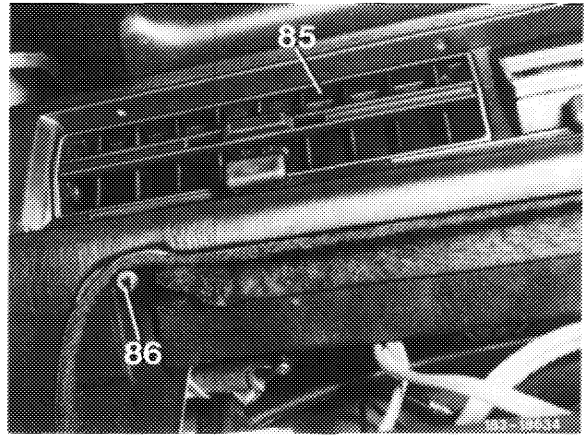

14 Insert Bowden cables (see arrow) and check function of side nozzle flaps, correctly adjusting Bowden cables if necessary by turning the knurled screw.

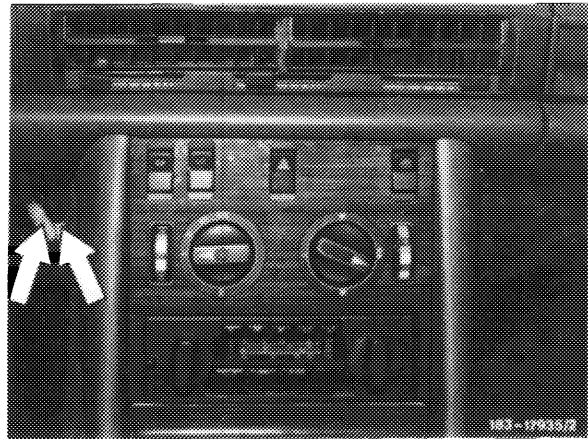

- 15 Install center console (68–200).
- 16 Install instrument cluster (54–310).
- 17 Install glove box (68–140).
- 18 Check function of automatic heating system.