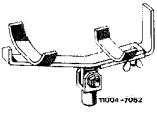
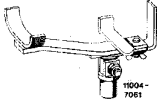

35-050 R and R rear axle subframe rear bushing

Tightening torques	Nm
Hex socket necked-down bolt for attaching rear rubber bearing to rear axle end cover (rubber bearing 1st version)	140
Hex. socket or hex. head screws for attaching rear rubber bearing to rear axle end cover (rubber bearing 2nd version)	120
Hex bolts for attaching rear rubber bearing to frame floor	25
Hex bolts, self-locking for attaching rear rubber bearing to frame floor	30
Special tools	
Vehicle jack top for removal and installation (large center piece) ¹⁾ of rear axle center piece	116 589 02 63 00
	
Vehicle jack top for removal and installation (small center piece) ¹⁾ of rear axle center piece	115 589 35 63 00
	

¹⁾ refer to installation survey rear axle center piece 35-500

Note:

During 1971 and 1972, the small and the large rear axle center piece for models 107, 114, 115 and 116 were occasionally provided with a rear axle end cover with large bulge.

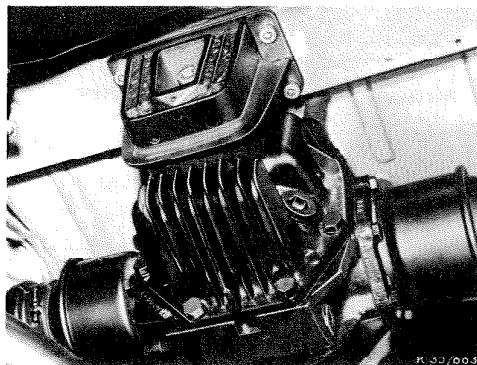

35-050 R and R rear axle subframe rear bushing

For this rear axle end cover, only the rubber bearing of the former version (1) applies. The rubber bearing (2) installed uniformly since the middle of 1978 cannot be used for reasons of available space.

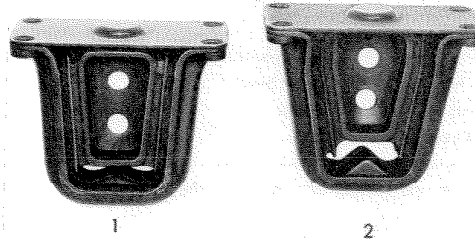

135-10855

Removal

1 Support rear axle housing on vehicle jack top and raise slightly.

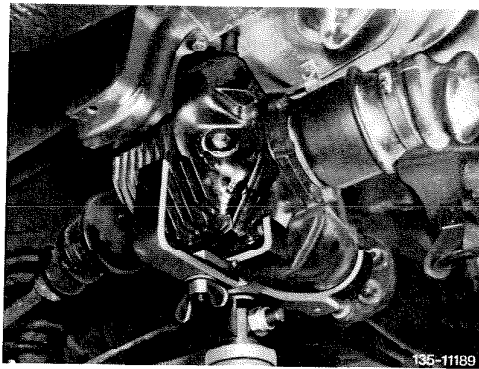

135-11189

2 Unscrew hex bolts or locking bolts on frame floor and slightly lower rear axle.

On models 115.114 and 123 with engine 617, with engine 616 starting March 1978, with engine 115 starting September 1979 and with engine 102, additionally loosen front stop limit from rear axle carrier (35-040).

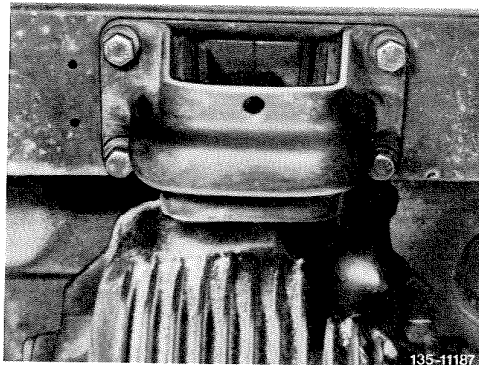

135-11187

1st version on models 107 and 106
2nd version on models 114 and 115

3 Unscrew hex. socket necked-down screw (43) and remove together with rubber bearing.

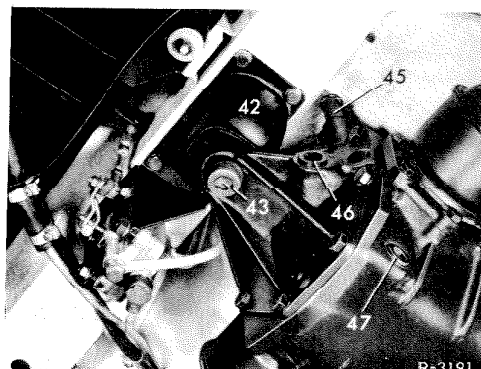

R-3191

1st version on models 114 and 115

35-050 R and R rear axle subframe rear bushing

4 Unscrew rubber mounting from rear axle end cover and remove.

1st version on models 107 and 116
2nd version on models 114 and 115

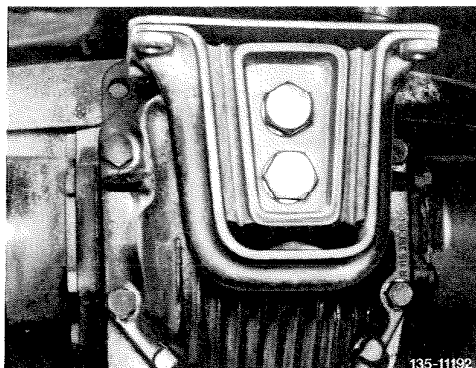

1st version on models 123 and 126
2nd version on models 107 and 116
Repair version on models 114 and 115

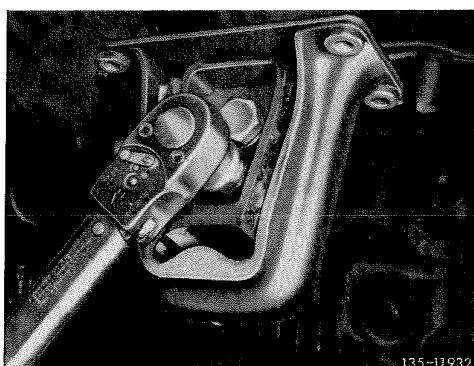

Installation

5 Attach rubber bearing (42) of 1st version to frame floor. Tightening torque of hex bolts 25 Nm (2.5 kpm).

Attention!

Rubber bearing is asymmetrically designed. To guarantee installation free of tensions, install rubber bearing with narrow end in driving direction.

1st version on models 114 and 115

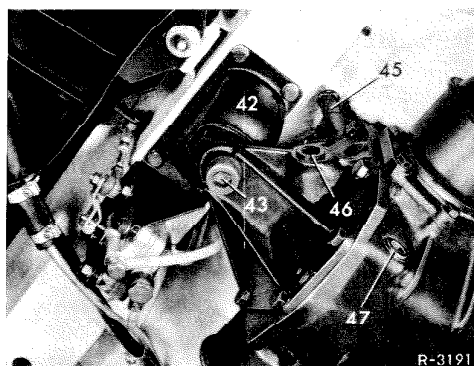

6 Lift rear axle and tighten hex socket necked-down screw (43) to 140 Nm.

Note: Always replace hex. socket necked-down expanding screw (43) after using screw once.

1st version on models 114 and 115

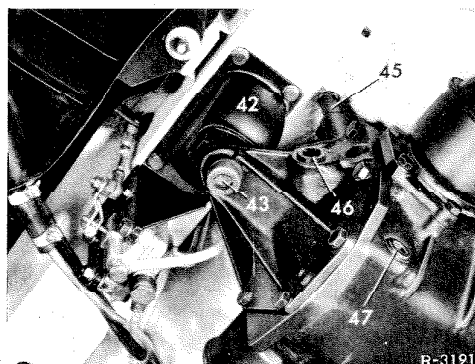

35-050 R and R rear axle subframe rear bushing

7 Attach rubber bearing to rear axle end cover.
Tighten hex. screws to 120 Nm.

1st version on models 107 and 116
2nd version on models 114 and 115

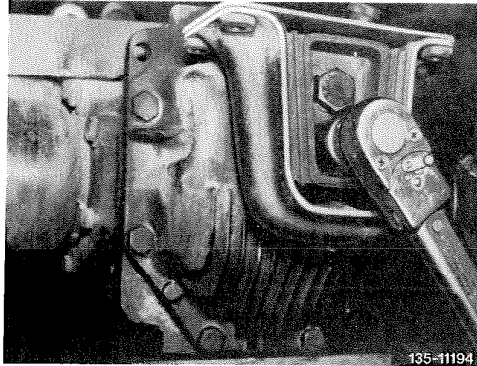

1st version on models 123 and 126
2nd version on models 107 and 116
Repair version on models 114 and 115

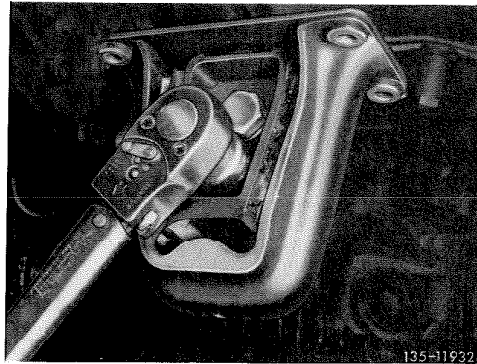

8 Lift rear axle and tighten hex bolts or self-locking
hex bolts of rubber bearing to frame floor at 25 Nm
or 30 Nm.

Attention!

Self-locking hex. screws with plastic coating (micro-encapsulated) or holders with all-metal lock nut on model 126 may be used **only once**.

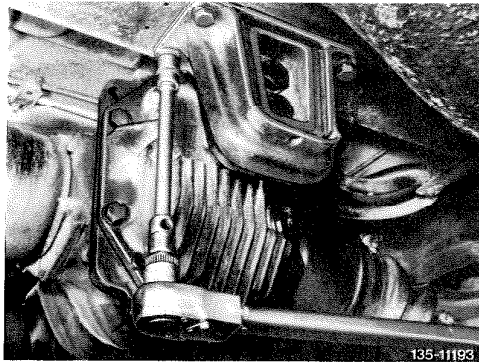

9 On rubber bearings **without** washers on fastening
eyes, use hex bolts with washers and snap rings only
(dimension a = 5 mm).

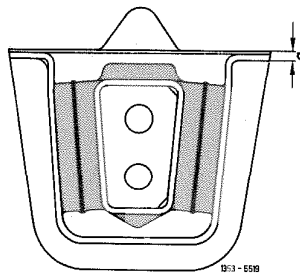

35-050 R and R rear axle subframe rear bushing

10 On rubber bearings with washers on fastening eyes use self-locking hex. bolts only (dimension b = 12 mm).

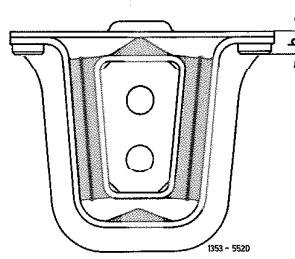

Model 126

11a Lift rear axle center piece up to frame floor and fasten rubber bearing to frame floor. Tightening torque of self-locking hex. bolts 1st version or hex. bolts 2nd version 30 Nm.

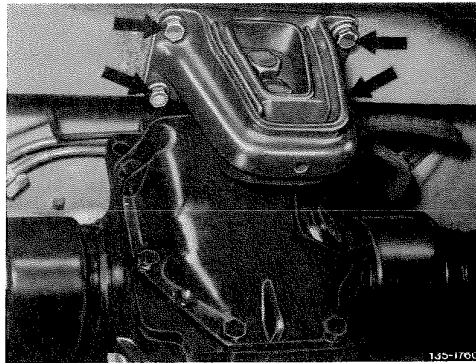

11b In the event of repairs, replace 1st version by 2nd version.

1st version
Self-locking hex. bolts
(arrow) and holder with nut
without lock

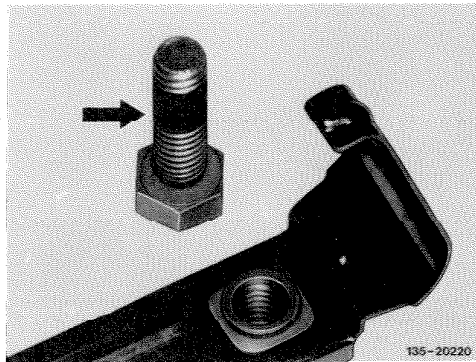

Attention!

Be sure to replace holder of 2nd version after one-time use.

2nd version
Hex. bolts without lock
and holder with self-locking
nuts (arrow)

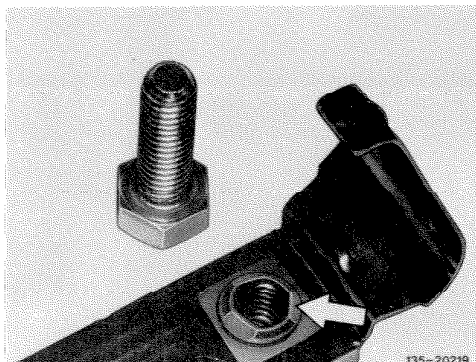

35-050 R and R rear axle subframe rear bushing

12 Lower pit lift or vehicle jack and remove top.

13 On models 115.114 and 123 with engine 617, with engine 616 starting March 1978, with engine 115 starting September 1979 and with engine 102, mount stop limit (2) and adjust (35-040).

