

## 32-520 Checking pressure reservoir

### Data

Gas filling pressure of pressure reservoir	when new	23 ± 1 bar
	min. value	15 bar

### Special tools

Filling funnel with filter



126 589 12 63 00

Box wrench insert open 11 mm 1/4" square, complete with change-over ratchet and 2 extensions for pressure oil lines

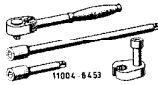

116 589 00 17 00

Tester for level control and hydropneumatic suspension

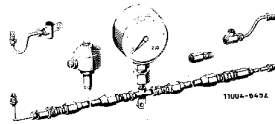

126 589 02 21 00

### Note

Inspection jobs require the following components of tester:

Pressure gauge (0-250 bar gauge pressure) with connection, coupling nut with sealing ring (038a), transfer connection (c), test hose (d), couplings (f), test line (g), and (l), bleed screws (n) and distributor (r). Screw only one bleed screw (n) into distributor (r).

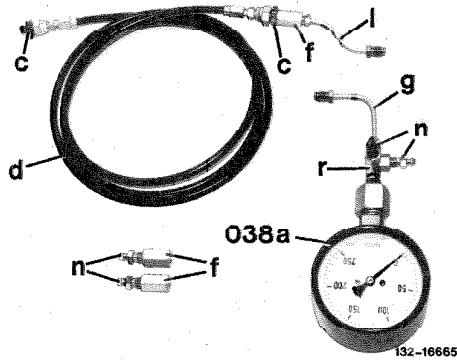

## 32-520 Checking pressure reservoir

Checkup of pressure reservoirs includes gas filling pressure and can be made on operational vehicle only, similar to pressure oil pump and to level controller.

Insufficient gas filling pressure results in an abnormal pressure increase during deflection. This will be noticed by a considerable hardening of the suspension system and may very well result in damage to suspension elements. In addition, hardening of suspension may lead to a reduction of the damping force of the spring struts, which in turn will result in an increased tendency toward rolling and toward rocking of vehicle when driving around alternating bends.

### Checkup

- 1 Disconnect connecting rod (7) on level controller (3).

Level controller  
Version up to 8/85

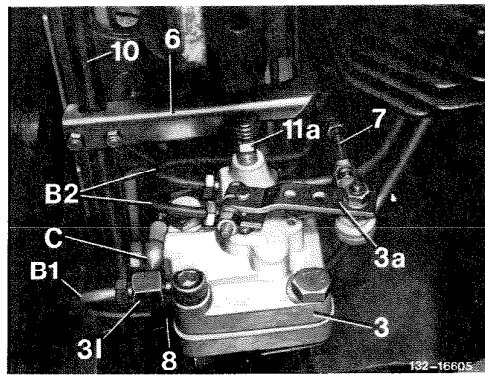

Level controller  
Version starting 9/85

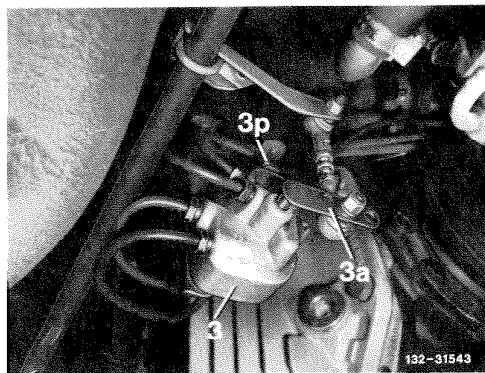

- 2 Set lever of level controller to „L“ (emptying).

F = Filling position  
L = Emptying position

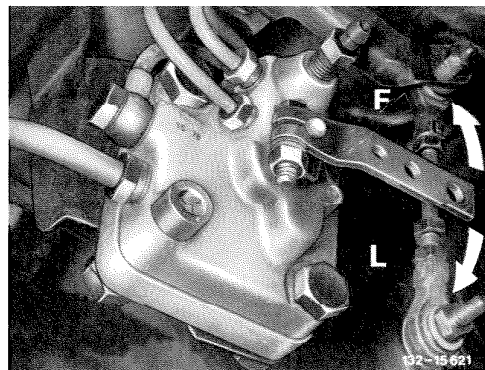

## 32-520 Checking pressure reservoir

3 Plug oil drain hose (061) on bleed screw (11a) on level controller (2nd version starting March 1977) or on distributor (1st version up to February 1977). Open bleed screw slowly and discharge pressure.

4 Remove bleed screw (11a) on level controller or on distributor.

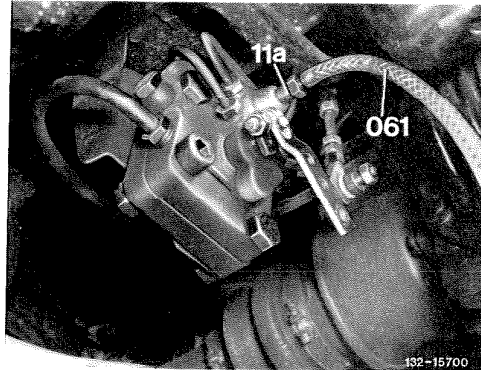

5 Connect pressure tester (038) with pressure hose (038d) to level controller or distributor.

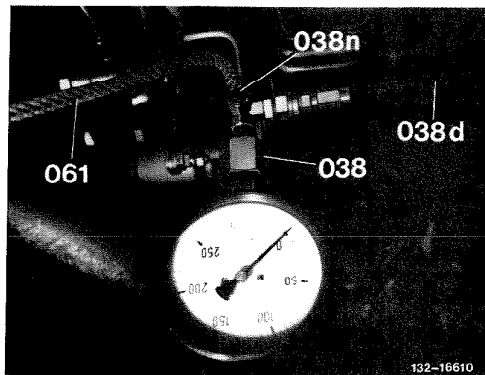

6 Disconnect pressure line (B2) on lefthand and righthand pressure reservoir (4). Close both pressure lines each time with coupling (038f) and bleed screw (038n).

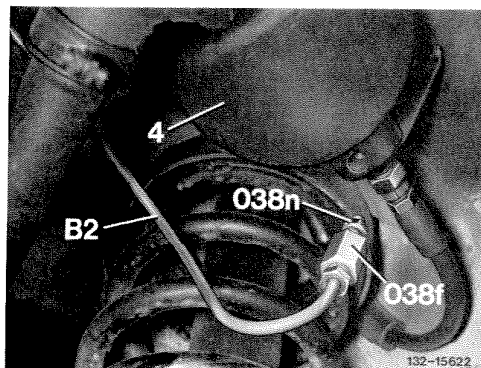

### Checking righthand pressure reservoir

7 Connect test hose (038d) of pressure tester to righthand pressure reservoir.

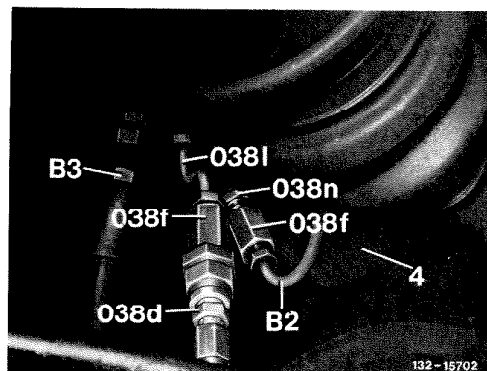

4 Pressure reservoir	B2 Pressure line level controller — pressure reservoir
038d Test hose	B3 Pressure line pressure reservoir — spring strut
038f Coupling	
038l Test line	
038n Bleed screw	

8 Set lever of level controller to „L“ (emptying).

9 Run engine at idle. Set lever of level controller to „F“ (filling), while paying attention to needle of pressure gauge.

10 The gas filling pressure of pressure reservoir is indicated when the needle of the pressure gauge rises continuously to a pressure value. This sudden rise is effected by the oil pressure as soon as the oil pressure exceeds the gas pressure. Set lever of level controller to „L“ (emptying). Stop engine.

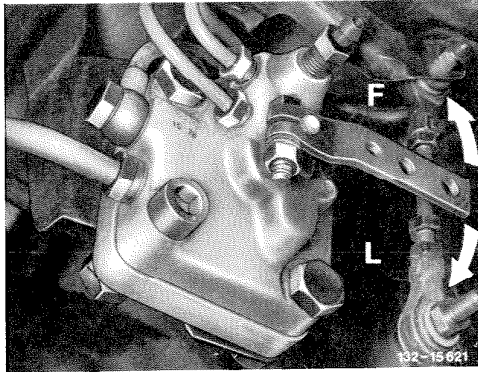

11 Plug oil drain hose (061) on bleed screw (038n). Open bleed screw slowly and discharge pressure. Catch the oil in a clean vessel.

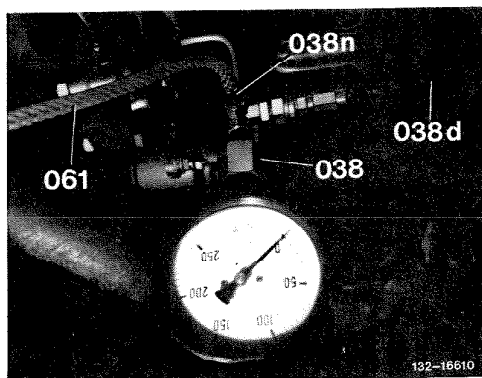

### Checking lefthand pressure reservoir

12 Connect test hose with lefthand pressure reservoir. Then perform jobs according to items 9 and 10.

13 Disconnect pressure tester. Mount bleed screw. Connect pressure lines to pressure reservoirs.

14 Fill caught oil through filling funnel (60) into fluid reservoir (2) in the engine compartment.

**Attention!**  
Reuse only clean oil.

15 Fill pressure oil system. Run engine at medium speed while setting lever of level controller for 30 seconds in position „F“ (filling).

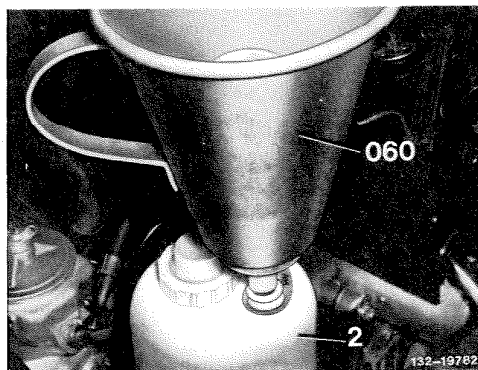

## 32-520 Checking pressure reservoir

16 Mount connecting rod for level controller.

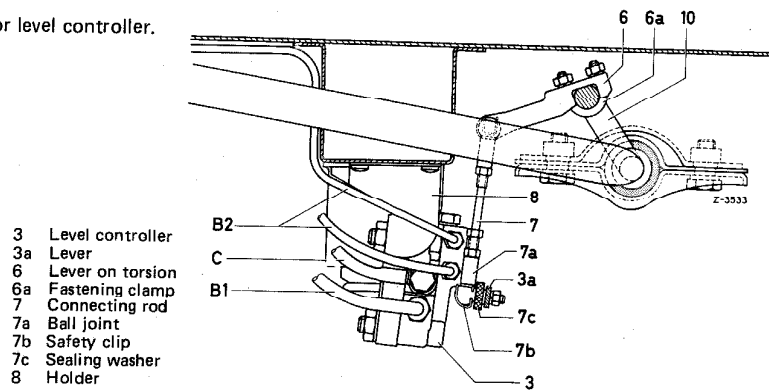

17 Check oil level in fluid reservoir (2) with engine stopped and correct, if required. In operational system and ready-for-driving condition the oil level should be between the marks „max.“ (a) and „min.“ (b). On loaded vehicle, an oil level at „min.“ mark will result.

