

# The CLS-Class



Mercedes-Benz



the CLS. A design object which has just one aim: to seduce you. Under the attractive exterior you feel it every step of the way. But you'll have no inkling that it emits far less CO<sub>2</sub> than other models, meanwhile, produce far less heat. This advanced technology requires less energy yet is not its only trump card. The CLS also features impressive qualities which only reveal themselves when you enhance your safety considerably. It's reassuring to be able to trust the new love in your hands of high-quality wood, fine leather and a trim with an elegant silver-chrome surface and a character that can be unforgiveable. Irresistible character: even when at a standstill, the CLS has the power that is visible is also palpable, as the suspension with selective damping system is now tuned to support you. And this is precisely what the ergonomically optimised individual seats in the rear don't sit in the back more often. How to fall in love in seconds. The CLS 63 AMG unleashes a new driving experience. **Sensuality and sense.** The athletic AMG design sets even the sportiest of drivers at ease. Side matters, too. If only high-performance sport had always been this easy and comfortable.



Your heart beats faster. Your mind knows why. The CLS reconciles reason and emotion. The four-door Coupé from Mercedes-Benz combines timeless elegance with expressive design like almost no other car. Passionate forms meet impressive technologies. Effortlessly superior sportiness is paired with an advanced safety concept.

Extraordinary appears to be the norm, which is what makes the car so unashamedly attractive. A blend of outstanding beauty and intelligent design. Of visual appeal and technical excellence. The CLS. The harmonious symbiosis of sensuality and sense.

At a glance | from page 4    Insight | from page 28

#### Featured models:

---

**CLS 350 BlueEFFICIENCY | designo alubeam titanium |** Cover, from page 2

5-spoke light-alloy wheels in anthracite, Exclusive PASSION leather in black/aubergine, black piano lacquer trim

---

**CLS 350 CDI BlueEFFICIENCY | designo zircon red |** from page 16

5-spoke AMG light-alloy wheels, black/porcelain leather, satin-finish light brown poplar wood trim

---

**CLS 63 AMG | iridium silver metallic |** from page 22

Triple-spoke AMG light-alloy wheels, black nappa leather, black piano lacquer trim

The illustrations may show accessories and items of optional equipment which are not part of standard specification

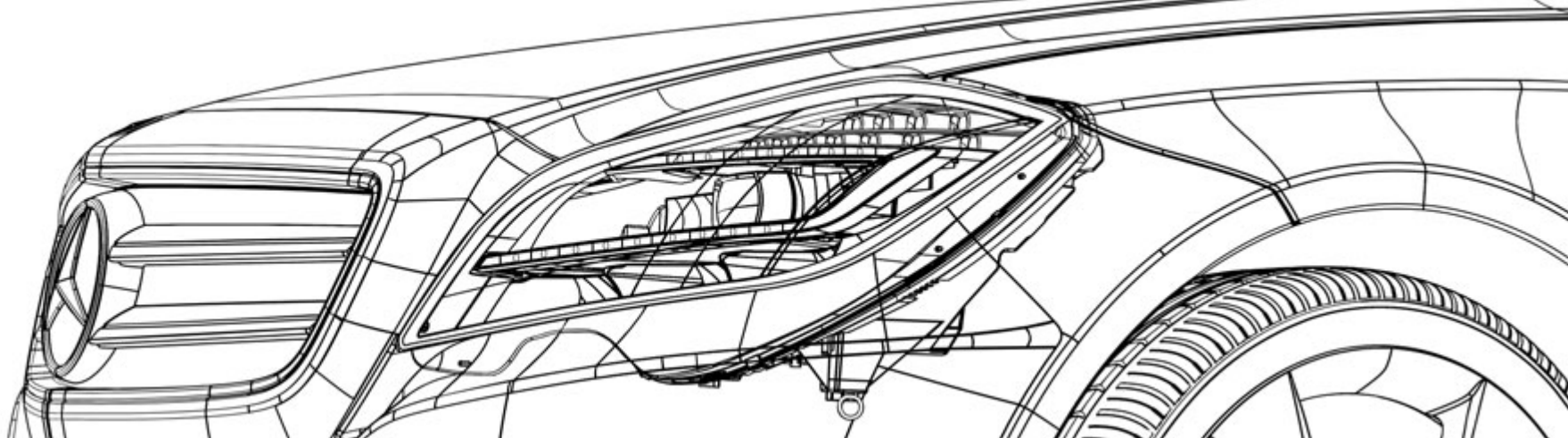

**Tangible dynamism:** BlueEFFICIENCY, diesel and petrol engines, transmission and chassis

Drive system & chassis | from page 36

**Maximum safety:** technology which can help to prevent possible accidents or can help mitigate their severity and consequences

Safety | from page 46

**Experience the essence of relaxed driving:** lighting, multimedia and assistance systems, and seats

Comfort | from page 50

**Exclusivity and performance:** CLS 63 AMG exterior, interior, technology and Performance Studio

AMG | from page 58

**CLS individuality:** standard equipment and optional extras, equipment packages, designo, upholstery and trim, wheels, genuine accessories

Equipment & appointments | from page 66

**Star service:** all you need to know about MercedesCard, Mercedes-Benz Financial Services, Mercedes-Benz mobility, Mercedes-Benz Museum, Test drive, Interactive Owner's Manual, Mobile internet, Service packages and Accident repairs

Services | from page 88

**The facts at your fingertips:** dimensions, paintwork and technical data

Facts & colours | from page 90



It's always difficult to control the emotions. Especially when looking at the CLS. A design object which has just one aim: to seduce you. Yet for all its expressive looks, there are just as many rational reasons for choosing the four-door Coupé. We'd like to show you some of them in this brochure. After all, seduction begins in the mind.

Sensuality and sense have never been closer





Sometimes, words are just not enough



A silver Mercedes-Benz CLS sedan is shown from a side profile, parked on a dark asphalt surface. The car is positioned in front of a brick building with a glass block window and a door. The scene is lit with dramatic, low-key lighting, creating strong highlights and deep shadows. The car's sleek design and alloy wheels are clearly visible.

## Looks that take your breath away. Technology that reduces your CO<sub>2</sub> emissions

Under the attractive exterior beats a powerful heart. Optimised engines extract even more driving enjoyment from every drop of fuel. The CLS lets you feel it every step of the way. But despite its impressive performance it emits far less CO<sub>2</sub> than its predecessor. → Page 36-41



The exciting design of the CLS leaves nobody cold. The optionally available LED high-performance headlamps, meanwhile, produce far less heat. This advanced technology requires less energy yet still provides particularly bright illumination. So now there's nothing standing in the way of a foray into the night. → Page 50-51

Even its lights are cool





## Looks that make your heart race. Safety systems that reassure you

Beauty is not its only trump card. The CLS also features impressive qualities which only reveal themselves at second glance. In critical driving situations, its safety and assistance systems can make all the difference and enhance your safety considerably. It's reassuring to be able to trust the new love in your life straight away.

→ Page 46-49





There's no shame in yielding to temptation as strong as the interior design of the CLS. The successful blend of high-quality wood, fine leather and a trim with an elegant silver-chrome surface appeals to all the senses and will satisfy even the most exacting of design and comfort requirements. In fact, not getting in would be unforgivable. → Page 56-83







## Unashamedly flirtatious

Irresistible character: even when at a standstill, the CLS has the power to captivate you. The optionally available AMG Sports package further enhances the feeling of athleticism. And that which is visible is also palpable, as the suspension with selective damping system is now tuned for even more agility. So don't hold back. Because the CLS certainly doesn't. → Page 74-75





Three magic words. Shortened to three letters



A close-up photograph of a light-colored leather car seat, likely from a luxury vehicle. The seat features vertical stitching on the backrest and a seatbelt strap. The background shows a dark, textured wall, possibly a brick wall, and the interior of a car.

Love is when somebody is always there to support you. And this is precisely what the ergonomically optimised individual seats in the elegant rear compartment do. Another hallmark of the four-door Coupé is its ample legroom. In fact, it's a shame you don't sit in the back more often. → [Page 56-57](#)









Here's looking at you

How to fall in love in seconds. The CLS 63 AMG unleashes your feelings. But it's not just the breathtaking acceleration that transforms every trip into an emotionally charged experience. The athletic AMG design sets even the sportiest of hearts racing. → Page 58-65

Quite possibly the world's fastest declaration of love









A beautiful body becomes even more attractive when it's honed to perfection. But what's inside matters, too. And that's exactly how it is with the CLS 63 AMG. Settle back into its AMG sports seats upholstered in nappa leather and select your own setup using the DRIVE UNIT. If only high-performance sport was always this easy and comfortable.

→ Page 60-61

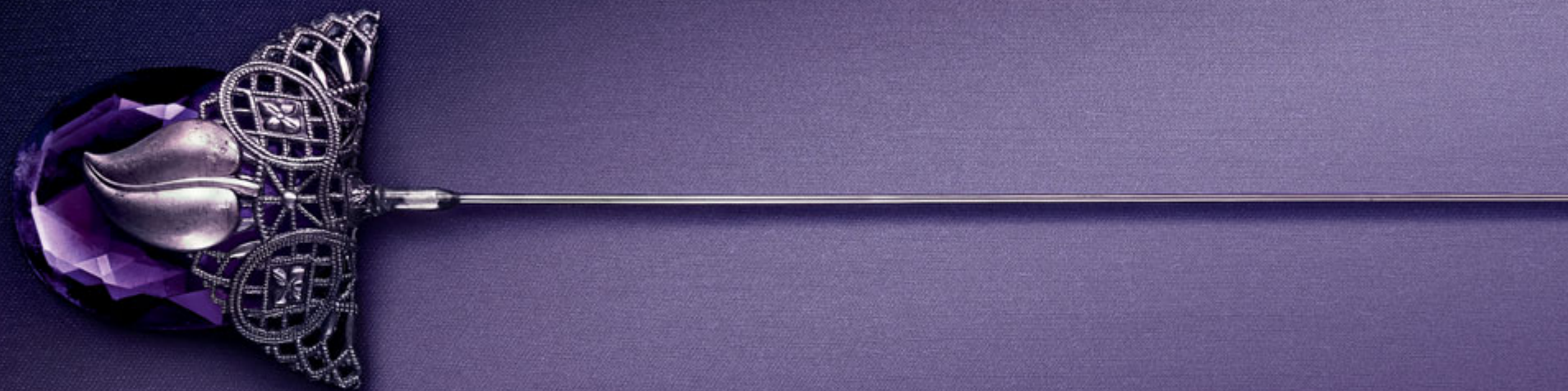

---

## How Bertha Benz sacrificed her hairstyle for the sake of progress

The wife of Carl Benz – the inventor of the motor car – could hardly have suspected that she was using the first emergency tool in the history of the motor car when she was doing her hair on the morning of a beautiful August day in 1888. Without telling her husband, Bertha Benz drove the “patent motor car” from Mannheim to Pforzheim to visit her mother. Sons Eugen (15) and Richard (14) accompanied her on the journey of over 100 kilometres, which would make history – because of the courage, skill and pioneering spirit which were needed.

That’s because the world’s first motor car had never before completed this distance on a single trip. Bertha Benz, however, knew what to do in practically any situation. Even when the petrol line in the patent motor car suddenly became blocked due to the poor fuel quality: “My hairpin came in very handy.” By sacrificing her hairstyle, Bertha Benz demonstrated the everyday practicality of the motor car: a stroke of marketing genius which heralded the future of mobility.





## The future is red, green and blue

The face of a car, its front section, conveys an impression of its character, its temperament and its dynamic credentials: car headlamps communicate this information particularly effectively when their form resembles that of the human eye.

Until recently, however, the limitations of the technology available to the designers hindered their efforts to attain this ideal. But a technological revolution has changed all that: headlamps featuring LEDs (light-emitting diodes). Bright, fast-responding and able to be controlled individually, LEDs in the additive basic colours red, green and blue open up exciting, unrivalled design possibilities which promise forms which have even greater emotional appeal and dynamic potential.

It is not just the aesthetic dimension that is enhanced by the new lighting technology. Visibility for the driver is also improved. This is because the light produced by the LEDs has a colour temperature of 5500 degrees Kelvin – the same as average daylight. And since the human eye has adapted itself to sunlight during the course of evolution, our eyes perceive LED light as particularly pleasant.



upholstery and trim. In an accident. Metallic paints. Sound system. Petrol engines. AMG  
nsion. Optional extra. Fuel consumption. Interior. In the event of danger. LED daytime  
ESP<sup>®</sup>. Dimensions. Standard equipment. Light. Multimedia systems. Drive system. Ge  
package. Transmission. Surround sound system. Wheels. Interior. Safe driving. CO<sub>2</sub> em  
nd trim. Assistance systems. BlueEFFICIENCY. In an accident. Metallic paints. Petrol e  
s. Top speed. Chassis & suspension. Optional extra. Fuel consumption. Interior. Airbag  
ts and colours. Climate control. Seats. ESP<sup>®</sup>. Dimensions. Standard equipment. Light.  
emissions. Memory package. Transmission. Surround sound system. Wheels. Interior.  
al data. Interior. Services. Safety. Assistance systems. Upholstery and trim. In an accio  
e driving. Light-alloy wheels. Top speed. Optional extra. Chassis & suspension. Fuel c  
Engines. AMG. **The facts.** Paintwork. Total displacement. Climate control. Seats. Dimer  
s. Light-alloy wheels. Memory package. Transmission. Surround sound system. Wheels

36 **BlueEFFICIENCY**37 **CLS BlueEFFICIENCY**38 **Diesel engines**

4-cylinder

6-cylinder

40 **Petrol engines**

6-cylinder

8-cylinder

42 **Transmission**

7G-TRONIC PLUS

44 **Chassis & suspension**

4MATIC (all-wheel drive)

DIRECT CONTROL suspension

AIRMATIC (air suspension)

Direct-Steer system

46 **Safe driving**

ATTENTION ASSIST

Night View Assist Plus

Lane Tracking package

Driving Assistance package Plus

LED tail lights and adaptive

brake lights

48 **In the event of danger**

PRE-SAFE® Brake

Brake Assist (BAS PLUS)

PRE-SAFE® system

49 **In an accident**

Airbags

Seat belts and NECK-PRO

head restraints

50 **Light**

LED high-performance headlamps

Intelligent Light System

Bi-xenon headlamps

LED tail lights with night design

52 **Multimedia systems**

COMAND Online

Audio 20 CD

Audio 50 APS with

6-disc DVD changer

Harman Kardon® Logic 7®

surround sound system

Rear Seat Entertainment System

54 **Assistance systems**

Speed Limit Assist

Reversing camera

Active Parking Assist

with PARKTRONIC

56 **Seats**

Memory package

Active Multicontour Seat package

NECK-PRO luxury head restraints

Individual rear seats

58 **CLS 63 AMG exterior**60 **CLS 63 AMG interior**62 **CLS 63 AMG technology**

AMG 5.5-litre V8 engine

AMG SPEEDSHIFT MCT 7-speed

sports transmission

AMG RIDE CONTROL sports

suspension

64 **AMG Performance Studio**

## The CLS-Class in detail

**66 Standard equipment****68 Optional extras****70 Equipment packages**

Exclusive package

Exterior Sports package

AMG Sports package

**76 designo****78 Upholstery and trim****84 Wheels**

Standard wheels

Optional wheels

AMG wheels

**86 Genuine accessories****88 Services**

MercedesCard

Mercedes-Benz Financial Services

Mercedes-Benz mobility

Mercedes-Benz Museum

Test drive

Interactive Owner's Manual

Mobile internet

Service packages

Accident repairs

**90 Dimensions****90 | 93 Paintwork****91 Technical data**

## BlueEFFICIENCY – fast forward to tomorrow



Mercedes-Benz is quicker at getting future technologies to where it matters most: on the road. By the end of 2012, you will have more than 140 Mercedes-Benz models with BlueEFFICIENCY technologies at your disposal, all of which help you reduce your impact on the environment. Our BlueEFFICIENCY concept comprises innovations for efficient mobility as well as optimised processes all the way along the value chain.

**The BlueEFFICIENCY measures – the Mercedes-Benz efficiency package.** This package consists of comprehensive vehicle optimisations which ease the burden on the environment. Each model combines the most efficient engine with intelligent, latest-generation aerodynamic and energy-management measures. Such measures include the ECO start/stop function, which is being made available for an increasing number of models. The BlueDIRECT V6 and V8 petrol engines, which feature in several model series, deliver a much higher power output while reducing fuel consumption by up to 25%.

**BlueTEC – the clean diesel.** A modular emission-control system makes BlueTEC an exceptionally clean diesel technology. As well as removing 95% of the particulate, it also reduces nitrogen oxides by up to 90%. What remains is mainly water and nitrogen.

**HYBRID – petrol and electric drives intelligently combined.** Here the electric motor can be used both for accelerating and for recuperating braking energy, which is stored in the battery. What's more, the ECU shuts off the petrol engine when the speed is below 15 km/h. In this way, a HYBRID implements significant fuel savings.

**BlueTEC HYBRID – clean diesel combined with electric drive.** It marries the benefits of the HYBRID with those of BlueTEC: during braking, the kinetic energy is converted into electrical energy, which can be re-used when required. At the same time, the BlueTEC technology cleans the exhaust gases and removes many of the pollutants. All of which makes the economical diesel powerplant even more efficient and clean.

**Innovative drive systems that break new ground: E-CELL and F-CELL.** We have developed two locally emission-free drive systems which have been produced on a small scale since 2010. The B-Class F-CELL<sup>1</sup> uses hydrogen to produce power for the electric motor, while the A-Class E-CELL<sup>1</sup> draws its energy directly from two lithium-ion batteries.

But that is not all: under the banner “Design for Environment”, we also look at a vehicle's entire lifecycle and work hard to preserve the environment from the planning stage right through to recycling. In addition, we are involved in the development of alternative fuels and carry out research in the field of bionics. Further information about our comprehensive measures can be found at [www.mercedes-benz.com/blueefficiency](http://www.mercedes-benz.com/blueefficiency)

<sup>1</sup> Provisional data: efficiency class: A++

The data are not based on an individual model and do not constitute part of the product offer; they are provided solely for purposes of comparison between different vehicle models

## CLS BlueEFFICIENCY

The CLS adopts a holistic approach, combining agility and dynamism with leading-edge efficiency technologies as well as extensive packages of measures aimed at optimising both fuel consumption and emissions



When we develop a new model, responsibility for our environment plays a major role. People's awareness is increasing as emissions, fuel consumption and fuel prices become topics that affect us all. It is therefore only natural that the CLS models should also be BlueEFFICIENCY models (with the exception of the CLS 63 AMG). And, far from being just a vision of a clean environment, BlueEFFICIENCY incorporates a whole raft of specific measures:

- 1 Ancillaries with energy-saving control (oil, water and fuel pumps, electromechanical steering)
- 2 Radiator shutter for CLS 250 CDI BlueEFFICIENCY and CLS 350 BlueEFFICIENCY
- 3 Alternator management with kinetic-energy recuperation
- 4 BlueDIRECT V6 and V8 engine generation with direct petrol injection, plus twin turbochargers for the CLS 500 BlueEFFICIENCY and CLS 500 4MATIC BlueEFFICIENCY
- 5 Refrigerant compressor only activated when actually needed
- 6 Optimised aerodynamics (exterior-mirror housings, front apron, rear apron, underbody)
- 7 ECO start/stop function (not for CLS 350 CDI BlueEFFICIENCY or CLS 350 CDI 4MATIC BlueEFFICIENCY)
- 8 All engines comply with the Euro 5 emissions standard
- 9 Wheels with optimised tyre rolling resistance (depending on the wheel/tyre combination)
- 10 Optimised 7G-TRONIC PLUS automatic transmission

## Diesel engines

Powerful and quiet with remarkably low fuel consumption and emissions: the CLS features the latest diesel technology from Mercedes-Benz

**4-cylinder in-line engine.** The 4-cylinder diesel powerplant displays contemporary qualities, including an impressive peak torque of 500 Nm, low fuel consumption, low emissions, quiet operation and an output of

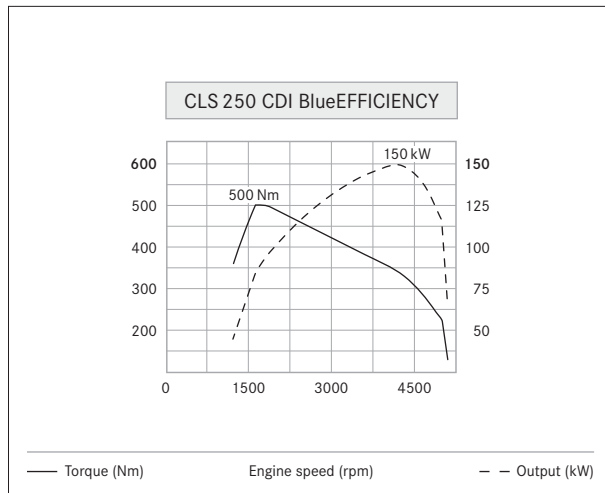

The CLS 250 CDI BlueEFFICIENCY achieves its peak torque of 500 Nm at between just 1600 and 1800 rpm

150 kW, which is exceptionally high for this displacement class.

This is made possible by a wealth of highly sophisticated technologies. The current-generation common-rail diesel technology impresses by virtue of an injection pressure of up to 2000 bar, optimised combustion chambers, and extremely fast and precisely controlled piezo injectors. High torque is available in every engine speed range thanks to the high ignition pressure and the two-stage turbocharger, while the requisite refinement comes courtesy of two Lanchester balancer shafts.

The ECO start/stop function stops the engine temporarily when the car comes to a halt, while optimised alternator management ensures consistent use of the engine's coasting phases as well as the braking process in order to recuperate kinetic energy. Meanwhile the radiator shutter reduces the aerodynamic drag when the engine requires only moderate cooling. But that is not all: this

model also features integrated measures such as tyres with low rolling resistance (depending on the wheel/tyre combination), intelligently controlled ancillaries and improved aerodynamics, all of which help to boost the car's efficiency sustainably.

**V6 engine.** The CLS 350 CDI BlueEFFICIENCY and the CLS 350 CDI 4MATIC BlueEFFICIENCY likewise place the emphasis on efficiency. A new intake and exhaust system with optimised inflow and outflow characteristics has been developed for the consumption-optimised V6 diesel engine, boosting the output to 195 kW, making this the most powerful diesel drive system with common-rail technology available for the CLS. On the other hand, fast and precisely controlled piezo injectors, a high injection pressure of up to 2000 bar and an optimised turbocharger help to save fuel. With the engine developing an immense peak torque of 620 Nm at 1600–2400 rpm, the result is effortlessly superior pulling power in all driving situations as well as a low



environmental impact and reduced fuel consumption compared with the predecessor model. What's more, the low engine noise level meets even the most exacting of requirements.



The CLS 250 CDI BlueEFFICIENCY combines pulling power with low fuel consumption and emissions

## Petrol engines

The BlueDIRECT petrol engines were developed with the aim of substantially reducing fuel consumption and emissions without compromising on dynamism and ride comfort. The result: advanced engine technology which sets standards for the industry



The engine of the CLS 350 BlueEFFICIENCY model can deliver supreme pulling power in every driving situation

**V6 engine.** Over 20% lower fuel consumption than the predecessor model and correspondingly lower CO<sub>2</sub> emissions yet enhanced dynamics – a neat way of summing up the CLS 350 BlueEFFICIENCY. These advantages are primarily down to the current-generation direct petrol injection from Mercedes-Benz, which operates using spray-guided combustion and high-pressure injection by means of piezo injectors. Maximum output is 225 kW, while the peak torque of 370 Nm is available between 3500 and 5250 rpm. Further factors which help to reduce fuel consumption include the standard-fit ECO start/stop function, an efficient intake and exhaust system, controlled ancillaries, intelligent alternator management, and consistently applied lightweight-design principles.

Outstanding refinement is another of the V6 engine's hallmark traits.

**V8 engine.** Fitted in the CLS 500 BlueEFFICIENCY, the powerplant from the BlueDIRECT engine family impresses with a combined fuel-consumption figure of 9.0 litres per 100 kilometres. This represents a 20% reduction in fuel consumption, with correspondingly lower emissions, compared with the predecessor model. Lightweight design, downsizing to a displacement of 4.7 litres as well as direct petrol injection with extremely fast and precisely controlled piezo injectors contribute to this, as do the innovative BlueEFFICIENCY technologies. The ECO start/stop function can stop the engine temporarily when the car is at a standstill.

At the same time, the CLS 500 BlueEFFICIENCY and the CLS 500 4MATIC BlueEFFICIENCY offer extremely impressive driving dynamics thanks to twin turbochargers and an intercooler. An output of 300 kW and a peak torque of 600 Nm, which is on tap from just 1600 rpm, mean effortlessly superior motoring in almost any situation. The V8 engine boasts impressive power delivery, even at low engine speeds, not to mention levels of quietness and refinement which are exceptional for an eight-cylinder unit. The turbochargers ensure that the engine provides high torque at low engine speeds – over 40% more at 2000 rpm compared to the predecessor engine.

All of which means that, to the driver, the V8 twin-turbocharged engine feels as comfortable and superior as a V8 naturally aspirated engine with a much higher displacement.

The flagship CLS model is the CLS 63 AMG with a 5.5-litre V8 twin-turbocharged engine developing up to 410 kW and 800 Nm<sup>1</sup>.



The effortlessly superior V8 engine developing 300 kW is available for the CLS 500 BlueEFFICIENCY and CLS 500 4MATIC BlueEFFICIENCY models

<sup>1</sup> With Performance package

## Transmission

Whether it be an economical or a sporty driving style – the 7G-TRONIC PLUS has been optimised in line with the model in which it is installed. Plus it is intuitive and ergonomic to use

**7G-TRONIC PLUS.** The CLS is fitted as standard with the 7G-TRONIC PLUS 7-speed automatic transmission and the DIRECT SELECT lever on the steering column. Shift paddles on the steering wheel enable the driver to influence the gear changes. Seven forward gears allow optimum revs, thus reducing fuel consumption. In city traffic especially, the 7-speed automatic transmission brings about a further reduction in fuel consumption thanks to the ECO start/stop function (not available for the CLS 350 CDI BlueEFFICIENCY and CLS 350 CDI 4MATIC BlueEFFICIENCY), which stops the engine automatically when the car comes to a halt. The electrohydraulic control unit, together with the engine and

transmission software, ensures exceptional gear-change dynamics and shift quality. The driver feels this in the car's more direct response to use of the accelerator pedal, for example.



Transmission control with the DIRECT SELECT lever on the steering wheel

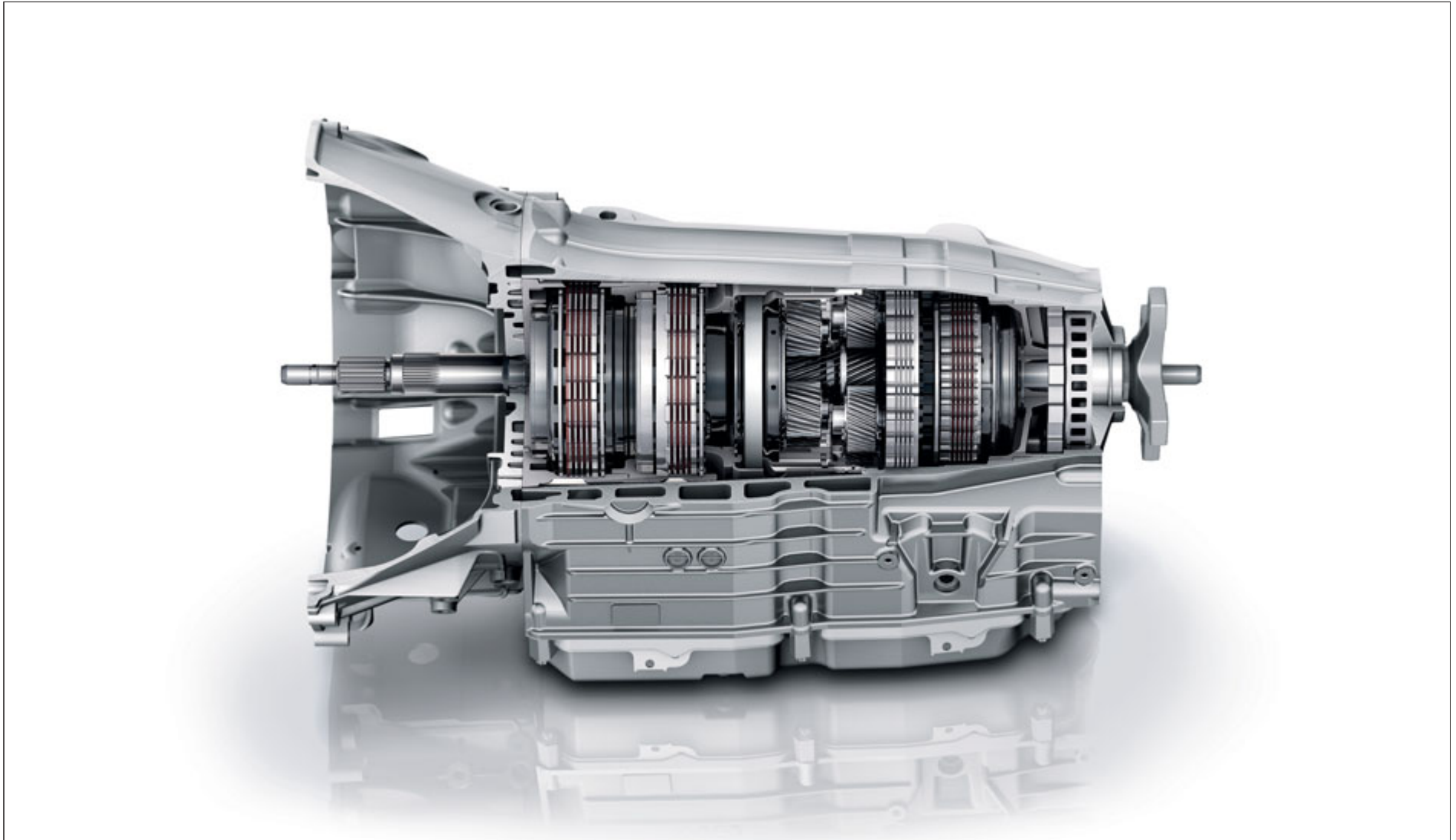

The 7G-TRONIC PLUS: one of over 18 million Mercedes-Benz automatic transmissions produced in a period spanning more than 50 years

## Chassis & suspension

4MATIC permanent all-wheel drive provides impressive traction as well as enhanced directional and driving stability. The chassis and the AIRMATIC air suspension really come into their own on the road, offering a high level of comfort yet also impressive agility

**4MATIC** (option). The 4MATIC all-wheel-drive system is always active and thus responds almost instantaneously in poor weather conditions such as rain, black ice or snow. 4MATIC is assisted by the Electronic Stability Program ESP® and the electronic traction system 4ETS. The latter enables controlled braking of spinning wheels and, as a consequence, increases the drive torque at the wheels offering good traction, making it

easier to move off and accelerate dynamically, especially on poor road surfaces. 4MATIC makes conventional differential locks superfluous: the automatic braking pulses make it easier to move off on slippery ground as well as enhancing stability during critical manoeuvres. A further advantage of the system is the fact that it is hardly any heavier than the rear-wheel-drive version on account of the compact design, intelligent choice of

materials and high level of efficiency. This four-wheel-drive system is fitted on the CLS 350 CDI 4MATIC BlueEFFICIENCY and CLS 500 4MATIC BlueEFFICIENCY models.

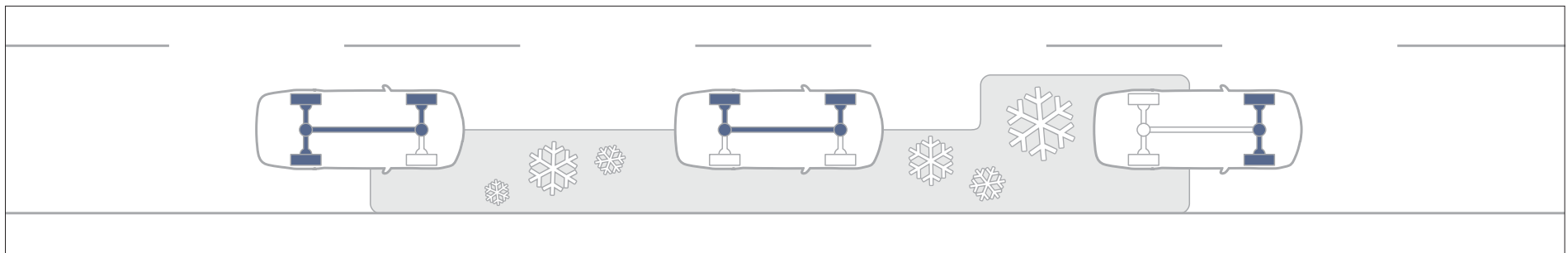

The electronic traction system 4ETS automatically sends the drive torque to the wheels offering sufficient traction

**DIRECT CONTROL suspension** (standard for 4 and 6-cylinder models). The suspension with selective damping system combines agility with ride comfort. The vibration dampers adapt automatically in line with the current driving situation, thus enhancing both damping and the car's stability – even on poor road surfaces. The DIRECT CONTROL suspension can also be optionally configured for out-and-out sports performance.

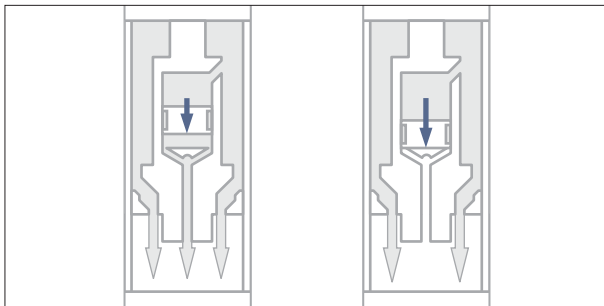

Agility with a high level of comfort – the DIRECT CONTROL suspension adjusts the shock absorbers automatically

**AIRMATIC** (optional for 4 and 6-cylinder models, standard for 8-cylinder models). AIRMATIC air suspension with adaptive vibration dampers adapts to the road and driving conditions, reducing road roar and tyre vibration levels while enhancing active safety when compared with conventional steel suspension. The driver can select either comfort-oriented or sporty settings manually. At high speed, the car is lowered automatically to improve driving stability, aerodynamics and fuel consumption.

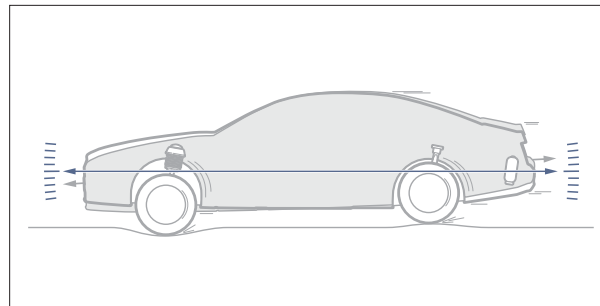

The AIRMATIC air suspension improves ride comfort, especially on poor roads

**Direct-Steer system** (standard). The Direct-Steer system achieves a significant reduction in the steering effort by adjusting the steering ratio as required in accordance with the road speed. When tight bends are being negotiated or parking is in progress, steering comfort is increased through a reduction in the steering wheel angle necessary for these manoeuvres. At high speeds, on the other hand, straight-line stability is enhanced as the steering input is processed to provide greater control. This improves the vehicle's agility, handling and steering comfort noticeably. An additional contribution is made by the reduction in the electromechanical power assistance as the car's speed increases. What's more, the special control concept of the Direct-Steer system reduces fuel consumption as it only requires power when steering movements are actually in progress.

## Safe driving

Mercedes-Benz pursues a comprehensive safety philosophy: the integral safety concept. At its core lies the vision of accident-free driving. Numerous measures support the driver in critical situations and can help to prevent an accident

**ATTENTION ASSIST** (standard). This drowsiness-detection system is especially useful on long trips. At speeds of between 80 and 180 km/h, ATTENTION ASSIST warns the driver as soon as it detects signs of increasing inattention or drowsiness. Sensors analyse driving behaviour and can detect deviations from a previously determined, individual driver profile.



If signs of increased driver inattention or drowsiness are detected, ATTENTION ASSIST advises taking a break

**Night View Assist Plus** (option). The central display highlights the entire area normally covered by main beam, as recorded by the Night View Assist system's infrared camera, in the form of a greyscale image – making it easier for drivers to get their bearings in situations where main beam cannot be switched on and allowing them to react quicker to people, animals or objects detected on or next to the road.



To ensure better visibility, Night View Assist Plus highlights pedestrians on the display

**Lane Tracking package** (option). Lane Keeping Assist can detect a traffic lane based on the road markings and, if the car is about to leave its lane unintentionally, warn the driver by making the steering wheel vibrate gently. Blind Spot Assist, meanwhile, uses two radar sensors in the rear bumper to monitor the blind spot at speeds above 30 km/h and can warn the driver against dangerous lane changes.



Lane Keeping Assist and Blind Spot Assist can warn the driver in potentially dangerous situations



**Driving Assistance package Plus** (option). This package includes DISTRONIC PLUS adaptive cruise control as well as Active Lane Keeping Assist and Active Blind Spot Assist. DISTRONIC PLUS helps the driver to maintain the desired distance between the car and the vehicle in front by braking the car, to a standstill if necessary, and then accelerating it again. Active Blind Spot Assist monitors the areas to the left and right beside the car

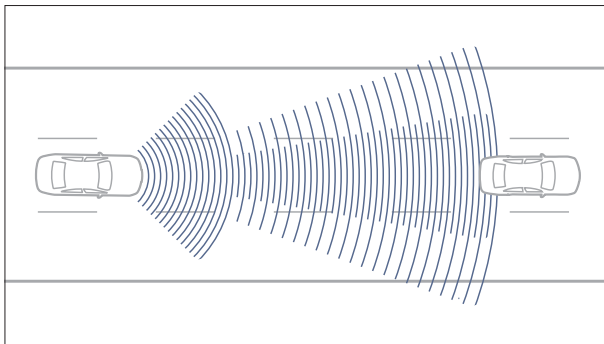

DISTRONIC PLUS adaptive cruise control can brake the car to a standstill and then accelerate it again, for example when driving in a queue

as well as to the side behind the car. If a vehicle is detected in the monitored area, a symbol appears in the exterior mirror's glass to warn the driver. If the driver misses this warning, indicates and starts to change lanes despite a further, audible warning signal, the system can intervene actively via the ESP® control and correct the direction of travel moderately. Active Lane Keeping Assist monitors the lane markings con-



Active Blind Spot Assist helps to enhance safety when changing lanes

tinuously. If the system detects the vehicle unintentionally crossing the white markings, it warns the driver by making the steering wheel vibrate gently. If the driver fails to respond, the system can also actively brake the vehicle to counter its departure from the lane.

**LED tail lights and adaptive brake lights** (standard). The tail lights, brake lights and third brake light employ LEDs and emphasise the sporty design of the car. During emergency braking, the adaptive brake lights signal a hazardous situation to the traffic behind by flashing.

## In the event of danger

Anybody who travels on the road will have to face a dangerous situation sooner or later. That's why a range of systems has been developed for the CLS to help reduce the severity and consequences of any accident

**PRE-SAFE® Brake** (optional in conjunction with DISTRONIC PLUS). As a three-stage warning and braking system, the PRE-SAFE® Brake can intervene prior to an impending rear-end collision: if there is no reaction from the driver following an initial visual and audible warning, the system can initiate autonomous partial braking as a tactile warning. If there is still no reaction from the driver, autonomous emergency braking can be initiated. The PRE-SAFE® Brake then reacts around 0.6 seconds before an accident deemed unavoidable and initiates emergency braking to reduce the impact speed and the severity of the collision.

**Brake Assist BAS PLUS** (optional in conjunction with DISTRONIC PLUS). Brake Assist BAS PLUS in conjunction with the PRE-SAFE® Brake can help to prevent

rear-end collisions. The anticipatory system uses radar sensors to evaluate driving situations autonomously and, if needed, provides extra braking power based on the distance to the vehicle in front and the relative speed. If the radar sensors detect a potential collision and the driver applies the brakes in time, BAS PLUS is primed to apply braking pressure in accordance with the available stopping distance. Furthermore, when the brakes are applied abruptly, the adaptive brake lights warn the traffic behind.

**PRE-SAFE® system** (standard). As a precaution, the PRE-SAFE® system can activate protective measures designed to prepare the occupants for a subsequent accident. Measures include reversible tensioning of the driver and passenger seat belts as well as automatic

closing of the open windows and/or the optional sliding sunroof – depending on the driving situation and the vehicle equipment.

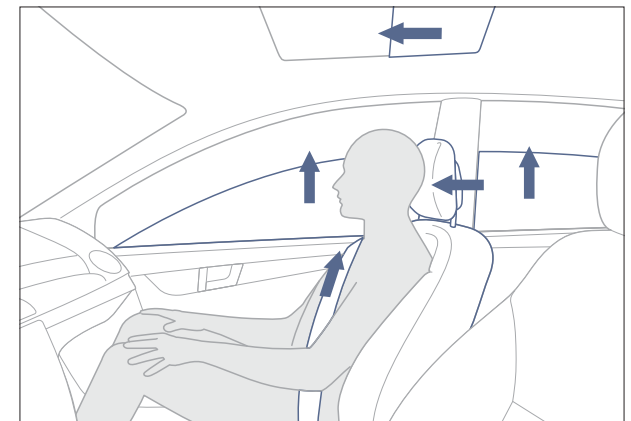

The anticipatory occupant protection system PRE-SAFE® can recognise critical driving situations and initiate preventive measures in order to protect the occupants

## In an accident

The CLS provides a safer environment, even in the event of a possible collision. Multiple protective measures are activated to help protect the occupants and significantly mitigate the consequences of accidents

**Airbags** (standard). Nine airbags are fitted to protect you and your passengers: the front airbags – deployed in two stages, depending on the predicted accident severity – are complemented by sidebags and pelvis-bags for the driver and front passenger as well as by windowbags. The kneebag can further reduce the forces exerted on the driver during an accident. Rear sidebags on both sides are available as an option.

**Seat belts and NECK-PRO head restraints** (standard). Seat belts are an essential part of occupant protection. Active elements make them even safer. Belt tensioners powered by electric motors react within a fraction of a second ahead of a possible accident and thus reduce the forces exerted on the occupants. What's more, the

NECK-PRO head restraints for the driver and front passenger can be activated in the event of a rear impact, depending on its severity: a spring mechanism pushes

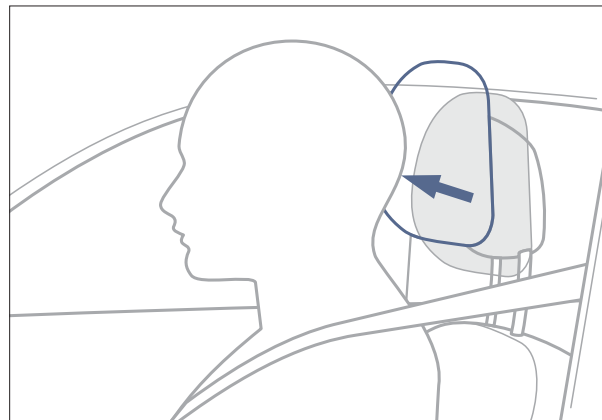

The NECK-PRO head restraints can reduce the risk of whiplash significantly in a rear impact

them forwards and upwards, meaning that support for the head can be provided earlier and the load exerted on the cervical vertebrae can be reduced.



The energy-absorbing crumple zones in the front and rear sections, an extremely robust safety passenger cell, and the doors with special reinforcing elements form an effective defensive barrier in an emergency

## Light

Good visibility in the dark enhances driving comfort and, above all, safety. That's why the CLS headlamps light up brighter than ever and even adjust in line with the course of the road



**LED high-performance headlamps with C-shaped side-marker lamps** (option). The optionally available dynamic LED high-performance headlamps (standard on the CLS 63 AMG) in combination with an LED daytime driving light strip in the bumper covering are exciting developments in the lighting sector. The sophisticated, distinctive design of the LED high-performance headlamps emphasises the dynamism of the vehicle form and lends the front end an exceptionally high-quality character. In the dark, the headlamps are unmistakable on account of the C-shaped LED side-marker lamps. The LED technology, used by Mercedes-Benz for the CLS for the very first time, combines maximum radiance with minimal energy consumption and a long lifetime. What's more, the light produced by the LED high-performance headlamps is very easy on the eyes, as its colour temperature of 5500 degrees Kelvin makes it closer to daylight than the light produced by xenon headlamps.

The LED high-performance headlamps are one of the design highlights and lend the CLS a unique night design

**Intelligent Light System** (in conjunction with optional LED high-performance headlamps – standard on CLS 63 AMG). All five functions of the Intelligent Light System – country mode, motorway mode, enhanced fog lamps, cornering light function and active light function – have been combined with LED technology for the first time ever. Adaptive Highbeam Assist ensures the best possible illumination of the road automatically in any driving situation.

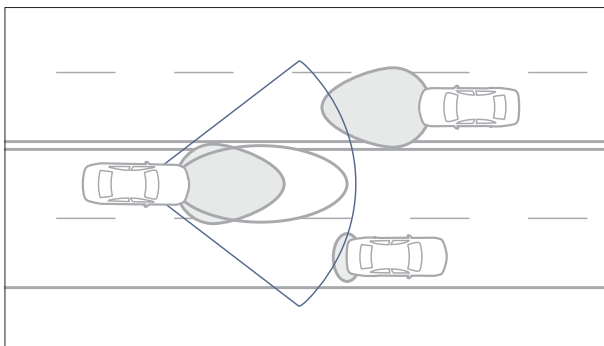

Adaptive Highbeam Assist always provides the best possible headlamp range automatically

**Bi-xenon headlamps** (standard). When set to low beam, the bi-xenon headlamps ensure better and wider illumination of the road verges. When switched to high beam, they have a much greater range than conventional headlamps. Dynamic, sensor-controlled range adjustment automatically compensates for any changes in the vehicle level when braking or accelerating.



The bi-xenon headlamps with circular daytime driving lights in the bumper come as standard

**LED tail lights with night design** (standard). The LED tail lights are drawn around into the car's flanks, giving the rear design its characteristic profile. The brake lights are based on the same look as the tail lights, and the luminosity of the LEDs is increased substantially during braking. Intermediate lenses highlight the contours even when the lights are switched off.



The LED tail lights dominate the rear view of the CLS

## Multimedia systems

The multimedia functions in the CLS can be operated via an easy-to-use Controller located on the centre console. Alternatively you can use the buttons on the devices themselves or the multifunction steering wheel. There are three head units available: Audio 20 CD, Audio 50 APS and COMAND Online



COMAND Online is a combination of audio system, navigation system and telephone functions. All of the main settings can also be programmed using the LINGUATRONIC voice-operated control system

**COMAND Online (option).** The multimedia system boasts a high-resolution 17.8 cm colour display. The system's functions include a radio, speed-sensitive volume control, the MUSIC REGISTER with a 10 GB hard disc and hard-disc navigation. What's more, it also includes free European map data updates for 3 years following initial registration. The best in entertainment is provided courtesy of the DVD player, which can play CDs and MP3 files as well as video and audio DVDs. The online function facilitates access to the internet and various Mercedes-Benz mobile services via an internet-capable mobile phone. A USB connection, an Aux-in socket, a slot for SD memory cards and a Bluetooth® interface allow connection to external data storage media and a mobile phone. The system is operated using the central Controller and the buttons on the multifunction steering wheel. The LINGUATRONIC system allows you to control COMAND Online using voice commands.

**Audio 20 CD** (standard). The Audio 20 CD radio features a 14.7 cm display, RDS/dual tuner with traffic information decoder, Bluetooth® interface and MP3-compatible CD player. A 6-disc CD changer is available as an option. All functions can be controlled conveniently using the multifunction steering wheel and the Controller on the centre console.

**Audio 50 APS with 6-disc DVD changer** (option).

Audio 50 APS combines the functions of an entertainment system: radio, CD/DVD player, DVD audio and MP3 player. It also features DVD navigation with 2-D map display, intersection zoom and the Traffic Message Channel, plus a Bluetooth® interface with a hands-free function. LINGUATRONIC voice-operated control enables convenient control of multimedia, communication and navigation functions.

**Harman Kardon® Logic 7® surround sound system** (option). The Harman Kardon® Logic 7® surround sound system delivers outstanding sound, as it has been custom-tuned for the interior of the CLS. With 14 high-performance speakers, including a woofer, and a 9-channel DSP amplifier, this 610-watt Dolby Digital 5.1 system delivers first-class acoustics when paired with the Audio 50 or COMAND Online system. Surround playback can be individually optimised for the entire



14 loudspeakers and 610 watts for the ultimate listening experience: the Harman Kardon® Logic 7® surround sound system

passenger compartment, the front area, the middle area or the rear area. The 3-D stereo sound and speed-sensitive volume control ensure constant listening pleasure and maximum sound precision.

**Rear Seat Entertainment System** (accessory). The optional Rear Seat Entertainment System offers the best in entertainment for the rear occupants. The system features two brilliant LCD colour screens, each with a 17.8 cm screen diagonal.

## Assistance systems

Assistance systems are designed to make life easier. In this respect, Speed Limit Assist, the reversing camera and Active Parking Assist enhance the feeling of comfort and safety in the CLS



Speed Limit Assist even indicates temporary speed limits

**Speed Limit Assist** (optional in conjunction with Audio 50 APS or COMAND Online). Speed Limit Assist can detect speed-limit signs by means of a windscreen-mounted camera and display them as symbols on the instrument cluster. The camera filters out circular speed-limit signs, regardless of whether they are at the side of the road or on a gantry above the road. Speed Limit Assist is especially helpful on routes with variable-message signs or road works. In addition, this system compares the displayed speed limits – such as when entering or leaving towns – with the data stored in the navigation system and shows the driver whether the car is travelling within the speed limit.



**Reversing camera** (optional in conjunction with COMAND Online). The reversing camera monitors the area directly behind the car with its wide-angle lens and sends the images to the central COMAND display. It is activated automatically when reverse gear is engaged, thus helping the driver when reversing.



During parking, the COMAND Online central display shows the area behind the car

**Active Parking Assist with PARKTRONIC** (option).

With Active Parking Assist from Mercedes-Benz on board, the car looks for a suitable parking space and parks in the space automatically at the push of a button, meaning that all the driver has to do once he or she has stopped, accepted the suggested parking space and engaged reverse gear is use the accelerator, gearshift and brakes. Active Parking Assist takes care of the steering



The display in the instrument cluster gives you a clear picture of the parking manoeuvres at all times

on its own. The system is extremely precise: for automatic parking, the parking space only needs to be 1.30 metres longer than the car.

During automatic parking, the PARKTRONIC ultrasonic sensors measure the distance to the vehicle in front and behind. Active Parking Assist uses a total of ten ultrasonic sensors – six in the front bumper and four in the rear bumper – as well as an electronic control unit, which processes the sensor signals and calculates the best possible line to take in order to park in the space.

## Seats

In terms of style, the link between the interior and exterior design of the CLS is seamless. The aesthetic individuality continues inside the car, adding distinctive touches and thus enhancing driving enjoyment



The active multicontour seats are designed to meet the highest requirements in terms of individual seating comfort, ergonomics and safety

The interior design picks up on the themes of the exterior design. For instance, the “dropping line” shaping of the door linings reflects the exterior’s dynamic, forward-thrusting side line, while the feeling of momentum generated by the centre console is mirrored in the doors and the beltline, thus giving the occupants a feeling of security. This feeling is further enhanced by elegant topstitching as well as the use of high-quality and authentic materials such as leather, wood and piano lacquer, depending on the interior appointments selected by the customer.

**Memory package (option).** The Memory package enhances convenience if several different people drive the car or sit in the front-passenger seat. A control panel is used to move the front seats, head restraints, steering column and exterior mirrors. Three different groups of settings can be stored for each seat. The integrated, electrically adjustable 4-way lumbar support allows each seat occupant to select their preferred settings.

**Active Multicontour Seat package** (option). The active multicontour seat with massage and dynamic functions for the driver and front passenger helps to ensure a comfortable ride on long trips. The seat contours can be adjusted to suit individual body shapes using the COMAND Controller. The NECK-PRO luxury head restraints for the front seats are integrated here.



The active multicontour seats with massage and dynamic functions

**NECK-PRO luxury head restraints** (optional, in conjunction with Multicontour Seat package and Active Multicontour Seat package). The flexible side bolsters of the luxury head restraints improve lateral support of the head and enhance comfort. Furthermore, the head restraints are activated by means of sensor control if a rear impact is detected. They are then moved into a better position to reduce the risk of whiplash injuries.



The NECK-PRO luxury head restraints can reduce the risk of whiplash injuries

**Individual rear seats** (standard). The luxurious ambience inside the CLS is underlined by the form, colour and materials of the seats. Individual rear seats, separated by a centre console with a folding armrest, further accentuate the individuality of the interior design. Four-rib vertical fluting in the seat cushions and backrests creates an unmistakable look.



Comfortable, individual seats await the rear passengers

## CLS 63 AMG exterior

AMG – three letters that are internationally synonymous with leading-edge technology, exclusivity and dynamism. The unique experience begins before you even get into the CLS 63 AMG – as you savour the exterior design → [www.mercedes-amg.com](http://www.mercedes-amg.com)

Just looking at the car is an electrifying experience in itself: from the exclusive AMG bonnet design to the AMG spoiler lip on the boot lid, the CLS 63 AMG impresses with its hallmark, energetically expressive AMG aura. This model combines the elegance of a coupé with the design of a sports car: the unique, wide

front wings, the single-louvre radiator and the powerful AMG front apron combine with the LED high-performance headlamps and exclusive AMG LED daytime driving lights integrated in the outer air dams to create a symbol of thrilling dynamism. This momentum is underlined by triple-spoke AMG light-alloy wheels painted in titanium

grey with a high-shine finish, the exclusive AMG diffuser-style rear apron with integrated rear fog lamp and, of course, the AMG sports exhaust system with chromed twin tailpipes.



CLS 63 AMG with LED high-performance headlamps



Triple-spoke AMG light-alloy wheels



AMG sports exhaust system with chromed twin tailpipes



Excitement and dynamism combined in an extra-special Coupé: the CLS 63 AMG

## CLS 63 AMG interior

One look at the interior of the CLS 63 AMG is all it takes to realise what the Mercedes-AMG experts mean by “custom-designed dynamism”

The interior of the CLS 63 AMG is an exciting blend of fine materials, refined craftsmanship and consistently sporty design. At the heart of the cockpit is the AMG DRIVE UNIT with E-SELECT lever and AMG emblem, which can be used for individual control of transmission modes, ESP® functions and suspension setups. Above this is the new AMG 3-spoke performance

steering wheel with flattened top and bottom sections, equipped with silver-coloured aluminium shift paddles, and the AMG instrument cluster with AMG main menu including RACETIMER. These sporty attributes are blended with exclusive flair: ergonomic AMG sports seats in nappa leather, brushed stainless steel for the AMG door sill panels and the AMG sports pedals,

which also feature non-slip rubber studs. A black piano lacquer trim and an analogue clock in exclusive IWC design complete the impression of style-conscious sportiness.



The AMG performance steering wheel and the AMG instrument cluster



The AMG DRIVE UNIT is at the heart of the cockpit



The interior of the CLS 63 AMG features a thrilling mix of fine materials and sporty design

## CLS 63 AMG technology

The AMG 5.5-litre V8 twin-turbocharged engine and the AMG SPEEDSHIFT MCT 7-speed sports transmission make for emotional driving experiences and outstanding efficiency. Yet when it comes to choosing a sporty or comfort-oriented driving style, the driver always has the final say in the CLS 63 AMG

**AMG 5.5-litre V8 engine.** The AMG V8 twin-turbocharged engine in the CLS 63 AMG impresses on two counts above all: its exciting dynamism and a level of efficiency that is nothing short of extraordinary in this output category. As you might expect from Mercedes-AMG, it produces a characteristic, powerful sound – with a rated output of up to 410 kW and a peak torque of 800 Nm when the optional AMG Performance package is on board. The low fuel consumption for this output category is achieved courtesy of direct

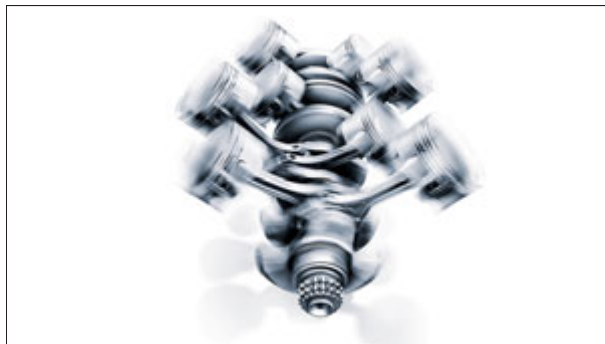

Motor-racing technology gives the AMG 5.5-litre V8 engine maximum agility

petrol injection with spray-guided combustion, twin turbochargers, alternator management and the Controlled Efficiency mode with start/stop function among other things.

**AMG SPEEDSHIFT MCT 7-speed sports transmission.** Bringing you the best of both worlds: the sporty, direct and agile feedback of a manual transmission paired with the outstanding convenience of an automatic. Yet the high-tech transmission still gives the driver a free



The AMG SPEEDSHIFT MCT 7-speed sports transmission offers customised modes for maximum driving pleasure

hand as, in addition to the “Race Start” and automatic double-declutching functions, it offers a further four individual modes: Controlled Efficiency – or “C” for short – stands for extremely consumption-optimised driving, while the “S” (Sport), “S+” (Sport Plus) and “M” (Manual) modes enhance dynamism. They allow gear changes in under 100 ms thanks to the partial suppression of individual cylinders when upshifting. A compact, wet clutch in place of the conventional torque converter translates accelerator pedal movements into forwards thrust instantaneously with optimum traction.

**AMG RIDE CONTROL sports suspension.** The wider front axle used for the AMG sports suspension enhances lateral dynamics substantially, while the electronically controlled damping system on the rear axle allows lightning-fast changes in the setup, depending on whether maximum agility or ultimate ride comfort is required. The AMG RIDE CONTROL sports suspension also offers an impressive array of individualisation



options, allowing the driver to select from a range of suspension modes: “Comfort”, “Sport” and “Sport Plus”.

Furthermore, it gives the driver the option of switching the ESP® dynamic handling control system to “ON”, “SPORT-HANDLING” or “OFF” mode. The AMG speed-sensitive sports steering has an even more direct ratio and, therefore, offers outstanding steering precision and direct turn-in ability. The AMG high-performance brake system with 360 mm brake discs ensures outstanding levels of deceleration and fade resistance. The front brakes deliver exceptional performance thanks to the same compound technology as that used in motor-sport and large 6-piston callipers.



## AMG Performance Studio

The AMG Performance Studio brings the sporty traits of the CLS 63 AMG even further to the fore, in terms of both performance and aura, by offering a wide range of attractive individualisation options

To further emphasise the sporty side of the CLS 63 AMG, the AMG Performance Studio offers the AMG Performance package which, as well as enhancing the performance of the CLS 63 AMG on a visual level – courtesy of the AMG carbon-fibre engine cover, the AMG carbon-fibre spoiler lip, the red-painted AMG callipers and the AMG performance steering wheel with Alcantara® inserts – also



The AMG performance steering wheel with Alcantara® inserts

boosts the rated output to 410 kW and the peak torque to 800 Nm. Further optional extras include an AMG trim in carbon fibre/piano lacquer, illuminated door sill panels, an AMG Exterior Carbon-Fibre package and 5-twin-spoke AMG forged wheels. Not to mention AMG performance suspension with even firmer settings in all three suspension modes and an AMG rear-axle



AMG ceramic high-performance compound brakes

differential lock for even better traction. The large AMG ceramic high-performance compound brakes are instantly recognisable by their specially painted callipers. They offer a precise pressure point, outstanding resistance to fading and exceptionally short stopping distances whilst reducing system weight by around 40%.

And for all those who desire even more dynamism, there is the AMG Driver's package, which gives an electronically governed top speed of 300 km/h (with participation in driver training at the AMG Driving Academy also included).

The AMG Performance Studio in Affalterbach can also meet other customer requests – including the production of one-off models.



High performance even when at a standstill: the CLS 63 AMG with AMG Performance package

## Standard equipment | Selection



3-spoke multifunction steering wheel in nappa leather



Audio 20 CD



DIRECT SELECT lever with shift paddles on the steering wheel



Headlamp Assist



THERMATIC automatic climate control



Cruise control



Analogue clock



Rain sensor



Bi-xenon headlamps with daytime running lamps (switched off)



Designer key



LED tail lights



Electrically adjustable front seats

## Optional extras | Selection



KEYLESS-GO package (incl. start/stop button)



COMAND Online with colour display (17.8 cm screen diagonal)



Climatised seats



Active Parking Assist with PARKTRONIC



Ambient lighting adjustable to three colours



THERMOTRONIC automatic climate control<sup>1</sup>

<sup>1</sup> Standard for CLS 500 BlueEFFICIENCY, CLS 500 4MATIC BlueEFFICIENCY and CLS 63 AMG



Memory package for storing three seat positions

Bi-xenon headlamps with LED daytime running lamps<sup>2</sup>

LED high-performance headlamps with LED daytime running lamps



Folding rear-seat backrests, 1/3 : 2/3 (EASY-PACK quickfold)



Sliding glass sunroof, electrically operated



EASY-PACK boot box

<sup>2</sup> Standard for CLS 500 BlueEFFICIENCY and CLS 500 4MATIC BlueEFFICIENCY

## Exclusive package

An interior with a hand-crafted look: the optionally available Exclusive package adds elegant touches by using the finest materials and stylish colour shades

All of the CLS interior colours are available for the optional Exclusive package. The roof lining, the pillar mouldings and the sun visors are trimmed in fine Alcantara®, while the velour floor mats feature a nubuck strip in the same colour as the appointments.



The ambient lighting

To complement the high-quality Exclusive PASSION leather upholstery, the dashboard, armrests, head restraints, centre console and upper section of the door panelling are trimmed in nappa leather. The ambient lighting with three selectable colours sets everything in



The dashboard trimmed in nappa leather

the right light, while a wood/leather steering wheel is available as an option. The Exclusive package can be combined with the Exterior Sports package and the AMG Sports package.



The optionally available wood/leather steering wheel





The optionally available luxury appointments in Exclusive PASSION leather with the dashboard trimmed in nappa leather

## Exterior Sports package

Should you wish to add carefully selected details to further emphasise the athletic character of your CLS, the optional Exterior Sports package could be just what you are looking for

Visual highlights are provided by the rectangular tail-pipe trims integrated in the bumper, finished in chrome on both sides. The sporty side of the CLS is given further emphasis by attractive 5-spoke light-alloy wheels with mixed-size tyres (front 255/40 R 18 and rear 285/35 R 18

or front 255/35 R 19 and rear 285/30 R 19) in silver or anthracite as well as the black-painted rear-bumper insert.

The Exterior Sports package makes your CLS look even more irresistible, while the steel suspension is fine-tuned with firmer dampers to make it even more sporty (not in conjunction with AIRMATIC air suspension).



5-spoke light-alloy wheels with mixed-size tyres – front 255/40 R 18 and rear 285/35 R 18 – in silver



5-spoke light-alloy wheels with mixed-size tyres – front 255/40 R 18 and rear 285/35 R 18 – in anthracite



The rectangular tailpipe trims in polished stainless steel integrated in the bumper are eye-catching features of the optional Exterior Sports package



5-spoke light-alloy wheels with mixed-size tyres – front 255/35 R 19 and rear 285/30 R 19 – in silver



5-spoke light-alloy wheels with mixed-size tyres – front 255/35 R 19 and rear 285/30 R 19 – in anthracite

## AMG Sports package

Get your CLS into tip-top shape. The sporty and athletic styling elements in the optionally available AMG Sports package lend your car extra dynamism all round

The powerful AMG front apron, the AMG rear apron with integrated chrome trim and the single-louvre radiator grille take the look of the CLS Coupé up another gear. The 4 and 6-cylinder models get a two-pipe sports exhaust system with visible, chromed tailpipe trims integrated in the rear apron. The steel suspension is firmer and more sporty. 5-spoke AMG light-alloy wheels with a high-sheen finish and mixed-size tyres (front 255/40 R 18 and rear 285/35 R 18) round off the dynamic exterior. Larger AMG light-alloy wheels

with mixed-size tyres (front 255/35 R 19 and rear 285/30 R 19) are available as optional extras. The interior is dominated by the 3-spoke multifunction sports steering wheel in black nappa leather (in almond beige if almond beige appointments are specified) with a flattened bottom section, including standard-fit shift paddles. The E/S/M switch allows the driver to select an economical, sporty or manual transmission mode. Floor mats with AMG lettering, sports pedals in brushed stainless steel with rubber studs, and the distinctive,

bright contrasting topstitching in conjunction with black upholstery in leather, PASSION leather or Exclusive PASSION leather complete the sporty interior.

The 8-cylinder CLS 500 BlueEFFICIENCY and CLS 500 4MATIC BlueEFFICIENCY models are equipped as standard with sports pedals, AMG front apron, single-louvre radiator grille, AMG rear apron with integrated chrome trim and two-pipe sports exhaust system.



The rear of the CLS with AMG Sports package

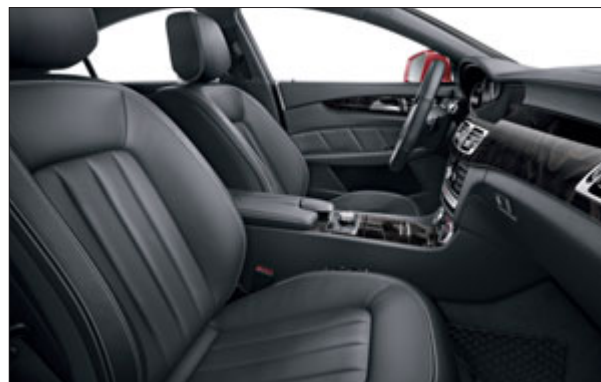

Sporty elegance in the interior



3-spoke multifunction sports steering wheel in nappa leather



The CLS in top form with the optional AMG Sports package

## designo

Individuality at its most alluring: the wide choice of options in the designo range allows you to hone the inimitable design of your CLS to perfection

→ [www.mercedes-benz.com/designo](http://www.mercedes-benz.com/designo)

The exclusive designo range for the CLS offers highly discerning customers a choice of attractive colour shades for the designo leather upholstery and impressive special paint finishes. The meticulously prepared designo trims are available in AMG carbon fibre/black piano lacquer. The centrepiece of the interior is the designo

leather upholstery available in a choice of ten designo colours. The seat cushions, head restraints and door centre panels as well as the armrests on the doors and on the centre console are finished in the selected designo colour. Further aspects of the designo appointments include the roof lining in black fabric and the velour

floor mats with edging in designo black leather and a designo metal badge. A truly special interior ambience is created by the designo Alcantara® roof lining in either anthracite, alpaca grey or macadamia beige.



Door centre panel and armrest in designo leather



designo badge



The interior with black piano lacquer trim and designo light brown upholstery

## Upholstery and trim







For the black colour scheme, there is a choice between seat covers in ARTICO man-made leather/fabric (standard) or optional seat upholstery in leather (standard for CLS 500 BlueEFFICIENCY and CLS 500 4MATIC BlueEFFICIENCY), PASSION leather or Exclusive PASSION leather, depending on model. In this case, the interior (seat covers, steering wheel, parcel shelf) is largely in black with contrasting grey surfaces for the roof lining and the A, B and C-pillars. The Exclusive PASSION leather appointments also include an additional nappa leather trim for the dashboard, window line, armrests, head restraints, door centre panels and centre console.

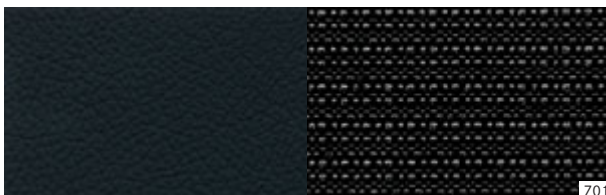

701



H19

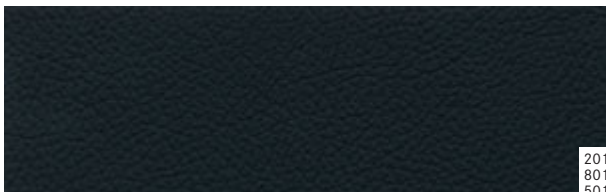

731

201  
801  
501

736



H21

---

**BLACK**

---

- 701 ARTICO man-made leather/fabric
- 201 Leather<sup>1</sup>
- 801 PASSION leather<sup>1</sup>
- 501 Exclusive PASSION leather<sup>1,2</sup>

---

**TRIM**



---

- H19 satin-finish light brown poplar wood
  - 731 high-gloss brown burr walnut wood<sup>1</sup>
  - 736 high-gloss black ash wood<sup>1</sup>
  - H21 black piano lacquer<sup>1</sup>
- 

<sup>1</sup> Optional extra    <sup>2</sup> Only in conjunction with Exclusive package

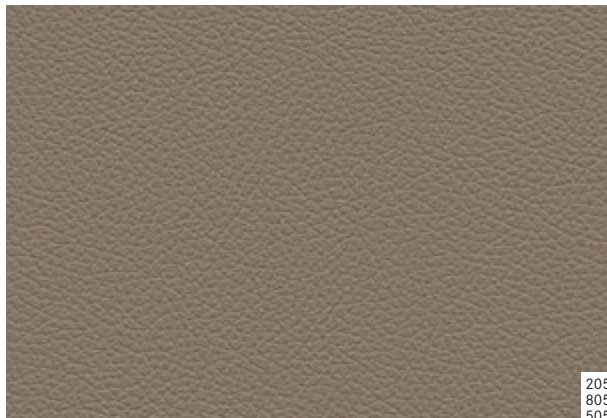

The almond beige colour scheme includes optional upholstery in leather (standard for CLS 500 BlueEFFICIENCY and CLS 500 4MATIC BlueEFFICIENCY), PASSION leather or Exclusive PASSION leather, depending on model. The seat covers, steering wheel, parcel shelf, roof lining, and A, B and C-pillars are all in almond beige. The Exclusive PASSION leather appointments also include an additional nappa leather trim for the dashboard, window line, armrests, head restraints, door centre panels and centre console.



205  
805  
505



H19



731



736



H21

#### ALMOND BEIGE

205 Leather<sup>1</sup>

805 PASSION leather<sup>1</sup>

505 Exclusive PASSION leather<sup>1,2</sup>

#### TRIM

H19 satin-finish light brown poplar wood

731 high-gloss brown burr walnut wood<sup>1</sup>

736 high-gloss black ash wood<sup>1</sup>

H21 black piano lacquer<sup>1</sup>

<sup>1</sup> Optional extra <sup>2</sup> Only in conjunction with Exclusive package



The black/aubergine colour scheme includes optional upholstery in leather, PASSION leather or Exclusive PASSION leather, depending on model. The steering wheel, roof lining, parcel shelf, and A, B and C-pillars are all in black, while the seats are in contrasting aubergine. To complement these appointments, the lower section of the dashboard, the front and rear of the centre console, the door centre panels, and the armrests are in the same colour. The Exclusive PASSION leather appointments also include a nappa leather trim for the dashboard, window line, armrests, head restraints, door centre panels and centre console.



207  
807  
507



H19



731



736



H21

#### BLACK/AUBERGINE<sup>1</sup>

- 207 Leather<sup>1</sup>
- 807 PASSION leather<sup>1</sup>
- 507 Exclusive PASSION leather<sup>1,2</sup>

#### TRIM

- H19 satin-finish light brown poplar wood
- 731 high-gloss brown burr walnut wood<sup>1</sup>
- 736 high-gloss black ash wood<sup>1</sup>
- H21 black piano lacquer<sup>1</sup>

<sup>1</sup> Optional extra    <sup>2</sup> Only in conjunction with Exclusive package



The alpaca grey colour scheme includes optional upholstery in leather (standard for CLS 500 BlueEFFICIENCY and CLS 500 4MATIC BlueEFFICIENCY), PASSION leather or Exclusive PASSION leather, depending on model. The seats, roof lining, A, B and C-pillars, and parcel shelf are all in alpaca grey, while the steering wheel is in contrasting black. The Exclusive PASSION leather appointments also include an additional nappa leather trim for the dashboard, window line, armrests, head restraints, door centre panels and centre console.

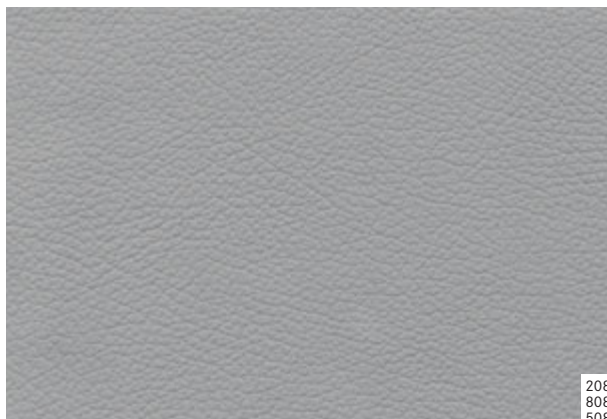

208  
808  
508



H19



731



736



H21

#### ALPACA GREY

208 Leather<sup>1</sup>

808 PASSION leather<sup>1</sup>

508 Exclusive PASSION leather<sup>1,2</sup>

#### TRIM

H19 satin-finish light brown poplar wood

731 high-gloss brown burr walnut wood<sup>1</sup>

736 high-gloss black ash wood<sup>1</sup>

H21 black piano lacquer<sup>1</sup>

<sup>1</sup> Optional extra <sup>2</sup> Only in conjunction with Exclusive package



The black/porcelain colour scheme includes optional upholstery in leather, PASSION leather or Exclusive PASSION leather, depending on model. The steering wheel, roof lining, parcel shelf, and A, B and C-pillars are all in black, while the seats and door centre panels are in contrasting porcelain. The Exclusive PASSION leather appointments also include a nappa leather trim for the dashboard, window line, armrests, head restraints, door centre panels and centre console.

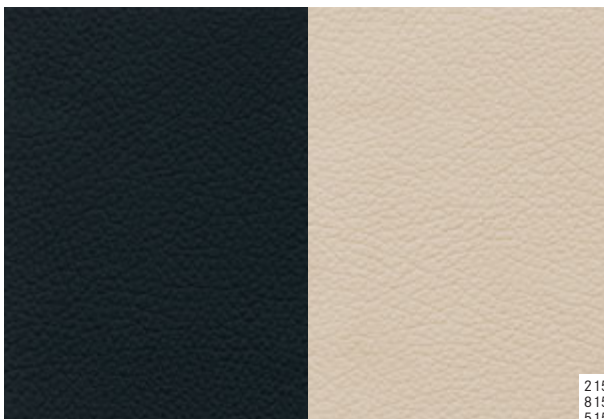

215  
815  
515



H19



731



736



H21

---

#### BLACK/PORCELAIN<sup>1</sup>

- 215 Leather<sup>1</sup>
- 815 PASSION leather<sup>1</sup>
- 515 Exclusive PASSION leather<sup>1,2</sup>

---

#### TRIM

- H19 satin-finish light brown poplar wood
  - 731 high-gloss brown burr walnut wood<sup>1</sup>
  - 736 high-gloss black ash wood<sup>1</sup>
  - H21 black piano lacquer<sup>1</sup>
- 

<sup>1</sup> Optional extra    <sup>2</sup> Only in conjunction with Exclusive package

## Wheels



10-spoke light-alloy wheels with 245/45 R 17 tyres (standard for CLS 250 CDI BlueEFFICIENCY, Code R25)



5-spoke light-alloy wheels with 255/40 R 18 tyres (optional for 4 and 6-cylinder models, standard for CLS 500 BlueEFFICIENCY and CLS 500 4MATIC BlueEFFICIENCY, Code R96)



5-spoke light-alloy wheels in silver with 255/40 R 18 front and 285/35 R 18 rear tyres (standard for Exterior Sports package, Code R32, in anthracite Code R36)



10-spoke light-alloy wheels with 245/45 R 17 tyres (standard for 6-cylinder models, optional for CLS 250 CDI BlueEFFICIENCY, Code R43)



15-spoke light-alloy wheels with 255/40 R 18 front and 285/35 R 18 rear tyres (optional, Code R34)



5-spoke light-alloy wheels in silver with 255/35 R 19 front and 285/30 R 19 rear tyres (optional for Exterior Sports package, Code R82, in anthracite Code R49)



5-twin-spoke light-alloy wheels with 255/40 R 18 front and 285/35 R 18 rear tyres, painted titanium silver (optional, Code R70)



5-spoke AMG light-alloy wheels with 255/40 R 18 front and 285/35 R 18 rear tyres, painted titanium silver with a high-sheen finish (standard for AMG Sports package, Code 790)



Triple-spoke AMG light-alloy wheels with 255/35 R 19 front and 285/30 R 19 rear tyres, painted titanium grey with high-sheen finish (standard for CLS 63 AMG, Code 797)



10-spoke light-alloy wheels with 255/35 R 19 front and 285/30 R 19 rear tyres, painted titanium silver with high-sheen finish (optional, Code R97)



5-spoke AMG light-alloy wheels with 255/35 R 19 front and 285/30 R 19 rear tyres, painted titanium silver with high-sheen finish (optional, Code 770)



Twin-spoke AMG forged wheels with 255/35 R 19 front and 285/30 R 19 rear tyres, painted titanium grey with a polished surface (optional for CLS 63 AMG, Code 793)

## Genuine accessories

A Mercedes-Benz can be a travel companion, an office or a living space. To make even better use of this diversity, the Mercedes-Benz range of genuine accessories has been fully customised for the CLS

Excellent entertainment for relaxed driving: the Rear Seat Entertainment System from Mercedes-Benz enables DVDs, CDs and video games<sup>1</sup> to be played on two brilliant LCD colour screens, each with a screen diagonal of 17.8 cm. The rear passengers can view a film together or each watch their own choice of content thanks to separate DVD players. In addition to this, further storage media can be used via the USB interface or SD card slot. Like every product from the range of genuine accessories, the Rear Seat Entertainment System meets stringent Mercedes-Benz occupant-safety requirements. The Rear Seat Entertainment System requires no factory pre-installations whatsoever and can be retrofitted easily.

The flamboyant high-end design of the incenio light-alloy wheels underlines the effortlessly superior presence of the CLS. The light-alloy wheels come in a range of different sizes and designs, such as 10-spoke wheels painted in black with a high-sheen finish paired with mixed-size tyres (front 255/35 R 19 and rear 285/30 R 19).

The door sills in brushed stainless steel provide the perfect backdrop for the white Mercedes-Benz lettering to shine.

The range of genuine accessories offers you a wide selection of high-quality items covering practically every aspect of your car. What you see here is just a small selection of what is on offer. Please also see our accessories brochure for further details, or contact

your Mercedes-Benz dealer, who will be pleased to advise you.

<sup>1</sup> External devices such as games consoles can be connected



incenio light-alloy wheels painted in black



Door sills with Mercedes-Benz lettering





With the Rear Seat Entertainment System, your enjoyment doesn't have to take a back seat

## Services

**MercedesCard.** The card is your ticket to the Mercedes-Benz experience. Four times a year, we will send you the Mercedes-Benz Magazine, featuring fascinating reports from the world of Mercedes-Benz and articles about our latest vehicles. A MercedesCard also has many other uses too. As a VISA credit card, it is an internationally accepted means of payment. Further benefits are available to provide you with peace of mind, such as insurance packages for your Mercedes and other insurance services for the whole family. Further details can be found at [www.mercedes-benz-bank.de](http://www.mercedes-benz-bank.de)<sup>1</sup>

**Mercedes-Benz Financial Services.** Mercedes-Benz stands for quality, innovation and safety – and the same applies to Mercedes-Benz Financial Services. Our innovative leasing and financing products are tailored to your financial needs and means, making it easy for you to secure the keys to your dream car. Once you are on the road, our insurance products offer you comprehensive protection on every trip. Finally, our service products ensure that your car is always in tip-top condition whilst keeping costs transparent and easily manageable. For a

detailed quotation, please contact your Mercedes-Benz dealer, who will be glad to go through the latest financial services and terms and conditions with you.

**Mercedes-Benz mobility.** Your new car comes complete with the promise of feeling safe on the road, but if you should ever need assistance, then Mercedes-Benz Service24h is there to help. Just call the freephone service hotline on 00800 1 777 7777<sup>2</sup>. The newly integrated telematics service, Mercedes-Benz Contact<sup>3</sup>, is even more customer friendly: a touch of a button is all it takes to contact the Mercedes-Benz customer centre. If you wish, the relevant vehicle and position-related data can be transmitted at the same time, thereby allowing the centre to react quickly and provide rapid on-the-spot assistance. Also standard with your new car at no extra charge is the Mercedes-Benz Mobilo<sup>4</sup> mobility package. Whether you have lost your key, had a breakdown which cannot be repaired immediately or suffered damage to the vehicle due to an accident or vandalism, Mobilo is there to help you reach your destination – anywhere in Europe. Whatever your problem, one

thing is certain: you will soon be able to resume your journey.

**Mercedes-Benz Museum.** Experience 125 years of automotive history against an architecturally impressive backdrop. Over 1500 exhibits on nine levels give you an insight into the unique tradition and powers of innovation of the Mercedes-Benz brand in Stuttgart. See the world's first two automobiles in the shape of the Benz Patent-Motorwagen (motor car) and the Daimler motorised carriage – plus the automotive future of Mercedes-Benz – in an area covering a total of 16,500 square metres. We look forward to your visit – online, too, at [www.mercedes-benz-classic.com/museum](http://www.mercedes-benz-classic.com/museum)

**Test drive.** The unique feeling of driving a Mercedes cannot be put into words. Which is why we'd like to invite you to experience it for yourself. Take a test drive and find out first hand how it feels to drive your dream car. Simply visit [www.mercedes-benz.com](http://www.mercedes-benz.com) to locate your nearest Mercedes-Benz dealer.

<sup>1</sup> Information about the MercedesCard in Austria and Switzerland can be found on the Mercedes-Benz websites for these countries <sup>2</sup> Alternative: +49 69 95 30 72 77. The only charge incurred is the cost of the mobile phone call to the landline network

**Interactive Owner's Manual.** The website also offers an interactive tour, enabling you to take a closer look at your desired model. Experience key functions in detail, gain an insight into the car's inner workings or look at the benefits of each model at [www.mercedes-benz.de/owners-manual](http://www.mercedes-benz.de/owners-manual)

**Mobile internet.** Now you can access the entire world of Mercedes-Benz from your mobile phone. As well as an overview of all the passenger car models, there are insights into the entire brand world along with a wealth of entertainment offers and direct links to our range of services at [www.mercedes.mobi](http://www.mercedes.mobi)

**Service packages.** Vehicle-specific services allow you to put together an individual package for your Mercedes-Benz: for a small monthly premium the Excellent service package covers all service jobs including maintenance, wear and repairs – for up to five years. Simply present your service card and you will be safe from any financial surprises. And you can rely on the fact that your Mercedes-Benz will remain

on top form for a long time to come. With the Advance service package your Mercedes-Benz will stay at its best for longer still: you will be protected against unexpected repair costs even after the manufacturer's warranty or the service package has expired – for up to ten years.



**Repair following an accident.** Should the worst come to the worst, the Mercedes-Benz accident repair service provides you with the best help available for your vehicle, which will retain its valuable safety properties. From work on the paint to bodywork or glass damage – optimally trained specialists will repair your Mercedes-Benz at your Mercedes-Benz service partner, and you will soon be back on the road again. Further information is available from your authorised Mercedes-Benz dealer.



<sup>3</sup> Requires a factory-fitted radio, connected to an operational mobile phone. The only charge incurred is the cost of the mobile phone call to the landline network <sup>4</sup> Once the warranty for breakdowns has expired (four years), Mobilo can be extended in periods of one year for a maximum of 30 years, provided that regular maintenance is carried out by your Mercedes-Benz service partner

## Dimensions

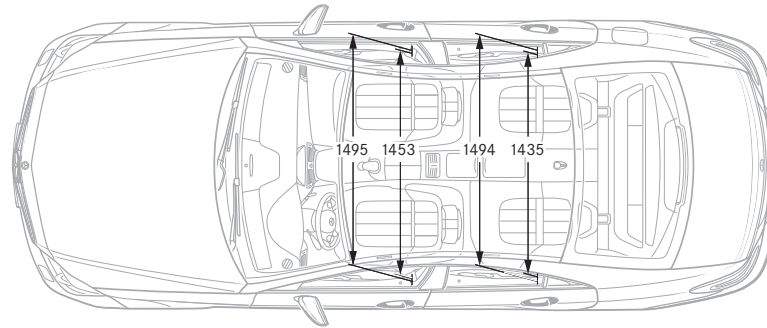
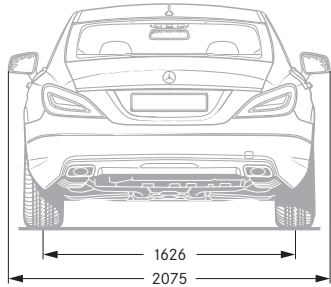
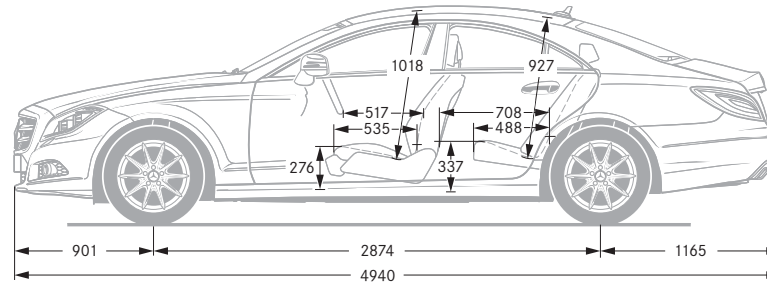
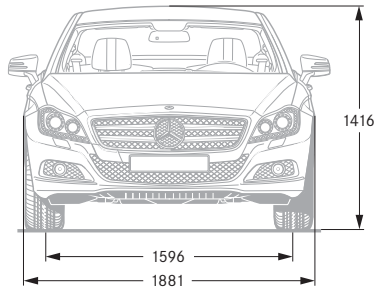

## Paintwork

The paint system developed by Mercedes-Benz includes an exceptionally resistant clearcoat and is a key factor behind the car's excellent value retention.

### NON-METALLIC PAINT

040 black

### METALLIC PAINTS<sup>1</sup>

197 obsidian black

497 cuprite brown

541 thulite red

755 tenorite grey

775 iridium silver

792 palladium silver

794 pearl beige

795 manganite grey SHAPE, matt paint

799 diamond white BRIGHT

890 cavansite blue

963 indium grey

### designo SPECIAL PAINTS<sup>1, 2</sup>

047 designo alubeam titanium

057 designo zircon red

# Technical data

	DIESEL ENGINES		
	CLS 250 CDI BlueEFFICIENCY	CLS 350 CDI BlueEFFICIENCY	CLS 350 CDI 4MATIC BlueEFFICIENCY
No. of cylinders/arrangement	4/in-line	6/V	6/V
Total displacement (cc)	2143	2987	2987
Rated output <sup>1</sup> (kW at rpm)	150/4200	195/3800	195/3800
Rated torque <sup>1</sup> (Nm at rpm)	500/1600–1800	620/1600–2400	620/1600–2400
Acceleration from 0 to 100 km/h (s)	7.5	6.2	6.4
Top speed, approx. (km/h)	242	250 <sup>2</sup>	250 <sup>2</sup>
Tyre size – front axle, rear axle	245/45 R 17	245/45 R 17	245/45 R 17
Fuel	Diesel	Diesel	Diesel
Fuel consumption <sup>3</sup> (l/100 km)			
Urban	6.5–6.4	7.8	8.8
Extra-urban	4.5–4.4	5.1–5.0	5.8–5.6
Combined	5.3–5.1	6.1–6.0	6.9–6.7
CO <sub>2</sub> emissions <sup>3</sup> (g/km) combined	138–134	160–159	181–177
Efficiency class	A	B	C
Emissions standard	Euro 5	Euro 5	Euro 5
Tank capacity (l)/incl. approx. reserve	59/8	80/9	80/9
Boot capacity (l)	520	520	520
Turning circle diameter (m)	11.27	11.27	11.27
Kerb weight <sup>4</sup> (kg)	1785	1815	1875
Perm. GVW (kg)	2270	2300	2360

<sup>1</sup> Figures in accordance with Directive 80/1269/EEC in the currently applicable version <sup>2</sup> Electronically governed <sup>3</sup> The figures shown were obtained in accordance with the prescribed measuring process (Directive 80/1268/EEC in the currently applicable version).  
The figures are not based on an individual vehicle and do not constitute part of the product offer; they are provided solely for the purposes of comparison between different vehicle models

	PETROL ENGINES			
	CLS 350 BlueEFFICIENCY	CLS 500 BlueEFFICIENCY	CLS 500 4MATIC BlueEFFICIENCY	CLS 63 AMG
No. of cylinders/arrangement	6/V	8/V	8/V	8/V
Total displacement (cc)	3498	4663	4663	5461
Rated output <sup>1</sup> (kW at rpm)	225/6500	300/5000–5750	300/5000–5750	386 (410)/5250–5750
Rated torque <sup>1</sup> (Nm at rpm)	370/3500–5250	600/1600–4750	600/1600–4750	700 (800)/1700–5000 (2000–4500)
Acceleration from 0 to 100 km/h (s)	6.1	5.2	5.2	4.4 (4.3)
Top speed, approx. (km/h)	250 <sup>2</sup>	250 <sup>2</sup>	250 <sup>2</sup>	250 <sup>2</sup>
Tyre size – front axle, rear axle	245/45 R 17	255/40 R 18	255/40 R 18	255/35 ZR 19, 285/30 ZR 19
Fuel	Premium petrol	Premium petrol	Premium petrol	Super Plus
Fuel consumption <sup>3</sup> (l/100 km)				
Urban	9.5–9.1	12.5	13.5–13.4	13.9
Extra-urban	5.6–5.4	6.9	7.5–7.4	7.6
Combined	7.0–6.8	9.0	9.7–9.6	9.9
CO <sub>2</sub> emissions <sup>3</sup> (g/km) combined	164–159	209	226–224	231
Efficiency class	C	E	E	F
Emissions standard	Euro 5	Euro 5	Euro 5	Euro 5
Tank capacity (l)/incl. approx. reserve	80/9	80/9	80/9	66/14
Boot capacity (l)	520	520	520	520
Turning circle diameter (m)	11.27	11.27	11.27	11.30
Kerb weight <sup>4</sup> (kg)	1735	1890	1940	1870
Perm. GVW (kg)	2220	2375	2425	2415

<sup>1</sup> Figures according to Directive 92/21/EC, version 95/48/EC (kerb weight with fuel tank 90% full, driver, 68 kg, and luggage, 7 kg) for standard-specification vehicles. Optional extras and accessories will generally increase this figure and reduce the payload capacity accordingly. Figures apply to engines with standard-fit 7G-TRONIC PLUS automatic transmission or AMG SPEEDSHIFT MCT 7-speed sports transmission (CLS 63 AMG). Figures in brackets apply to the CLS 63 AMG with optional AMG Performance package

NON-METALLIC PAINT



040

METALLIC PAINTS<sup>1</sup>

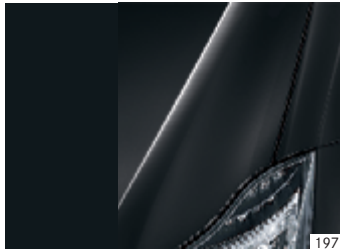

197



775



799



497



792

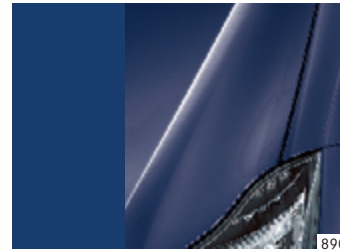

890

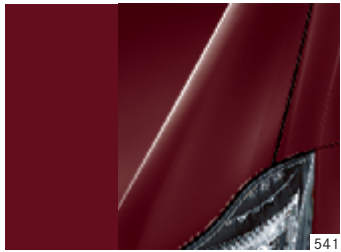

541



794

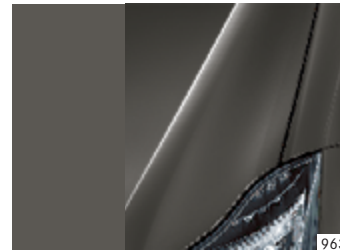

963



755



795

designo SPECIAL PAINTS<sup>1,2</sup>

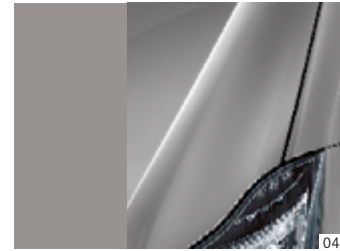

047



057

**Take-back of end-of-life vehicles.** At the end of its long life, you can return your CLS-Class to us for environment-friendly disposal in accordance with the EU End-Of-Life Vehicle Directive<sup>1</sup>. But that day lies a long way off.

<sup>1</sup> Applies in accordance with national regulations to vehicles up to 3.5 tonnes gross weight. Mercedes-Benz passenger cars have met the statutory regulations governing the suitability of their design for reuse and recycling for a number of years now. A network of vehicle take-back depots and dismantlers has been established which will process your vehicle in an environment-friendly manner. The ways in which both vehicles and parts can be recovered are subject to ongoing development and improvement. Consequently, the CLS-Class will be able to comply with any future increases in the recycling quota within the stipulated time limits

**Please note:** changes may have been made to the product since this brochure went to press (22.07.2011). The manufacturer reserves the right to make changes to the design, form, colour and specification during the delivery period, provided these changes, while taking into account the interests of the vendor, can be deemed reasonable with respect to the purchaser. Where the vendor or the manufacturer uses symbols or numbers to describe an order or the subject of an order, no rights may be derived solely from these. The illustrations may show accessories and items of optional equipment which are not part of standard specification. Colours may differ slightly from those shown in the brochure, owing to the limitations of the printing process. This brochure is distributed internationally. It provides a general indication of the range of models, features, optional extras and colours available in various countries. Some of the models, features, optional extras and colours shown may not be available in your country or may only be available in a different specification. Additionally some models, features, optional extras and colours may only be available in combination with others. For current and more specific information in relation to the range of models, features, optional extras and colours available in your country, and their pricing, you should contact your nearest authorised Mercedes-Benz Passenger Car Dealer. [www.mercedes-benz.com](http://www.mercedes-benz.com)