

The all-new 2012 **M-Class**



Mercedes-Benz
The best or nothing.

A champion among luxury SUVs.

The all-new 2012 M-Class is a dynamic presence both on and off the road. Whether driving through rough terrain or cumbersome city roads, this impressive vehicle provides a comfortable ride even when the conditions are not. Modern, stylish and void of the ordinary, the 2012 M-Class will exceed your expectations.

The M-Class

DESIGN	2
ENTERTAINMENT & COMMUNICATION	6
AGILITY	8
BlueEFFICIENCY & 4MATIC™	12
SAFETY	14
COLOURS & MATERIALS	16
EQUIPMENT LISTING	20
ACCESSORIES & TECHNICAL DATA	22
OWNERSHIP, WEBSITE & TEST DRIVE	24





ML 350 4MATIC™.

Assured beauty in confidence.

An unmistakable aura of power emanates from the M-Class. Situated handsomely with an aggressive AMG styled body, triple-louvre radiator grille with the embedded three-point star, and a new large chrome-style under-guard at the front and rear. With the body contours accented by cool-white LED daytime running lights and 19" 5 twin-spoke wheels, the M-Class stands as proof that beauty is not always in the eye of the beholder.



LED daytime running lights.





ML 350 4MATIC™.



ML 350 4MATIC™ interior.



Make yourself comfortable.

Rich ARTICO leather covered door panels and ergonomic seats along with finely appointed wood trim and chrome details promise a sporty, elegant and high-quality interior character. Optional highlights include climate comfort fronts seats, heated rear seats, panoramic sunroof and wood/leather steering wheel, providing further comfort, spaciousness and interior luxury.



Ambient lighting with polar, neutral and solar colour settings.

Get the show on the road. Or off it.

The 2012 M-Class provides entertainment and convenient communication technology. With the optional COMAND APS with HDD navigation and DVD player and harman/kardon® LOGIC7® surround sound system, confident navigation and crystal clear onboard entertainment allow for a pleasurable and easily navigated drive.

Integrated into your vehicle's audio system, standard SIRIUS Satellite Radio¹ offers 120 channels of music, sports, news, talk and comedy providing you freedom to choose your audio experience wherever you drive. With coast-to-coast reception coverage, listen to what you want, when you want, in your SIRIUS equipped M-Class.

Additionally, the available Media interface syncs with your iPod® to let you browse artist album artwork similar to your iPod®.



¹© 2011 SIRIUS Satellite Radio Inc. "SIRIUS," the SIRIUS dog logo and related marks are trademarks of SIRIUS Satellite Radio Inc. Complimentary 6 months of service included. Monthly subscription required for service thereafter.



COMAND APS with
HDD navigation and DVD player.



ML 350 4MATIC™.



302 horses are rarely this quiet.

Hidden beneath the ML 350 4MATIC™'s, broad, chiseled hood lies a momentous powerplant – the new 3.5 L direct injection V6. With an amazing 302 horsepower and 273 lb-ft of torque, this engine offers excellent performance. What's more, it comes mated to the 7G-TRONIC PLUS automatic transmission for smooth, optimized gear shifting.

The ML 350 BlueTEC 4MATIC™ comes with the new 3.0 L Turbo V6 Diesel Engine, revised for greater power and efficiency. It delivers an impressive 240 horsepower, 455 lb-ft of torque delivering outstanding towing capacity and fuel efficiency.



3.5 L direct injection V6.

Ride like you are on air.

The M-Class takes driving enjoyment to new levels – literally – with the optional AIRMATIC Air Suspension as part of the sport package. When travelling at high speeds, the ride height of the M-Class is automatically lowered, minimizing drag, reducing fuel consumption and improving handling. When travelling with a heavy payload, the air suspension keeps the ride height of the vehicle constant at all times. The Sport Package also includes the Adaptive Damping System (ADS) with its two manually selectable damper settings: ‘Sport’ and ‘Comfort’.

Take comfort to a whole new level.

The M-Class is fitted standard with the 7G-TRONIC PLUS 7-speed automatic transmission. Gears are selected directly, ensuring uninterrupted torque delivery, virtually imperceptible shifts and enhanced ride comfort. Should you need to brake sharply or accelerate quickly, gears can be skipped to allow for quick maneuverability. 7G-TRONIC PLUS 7-speed automatic transmission also allows you to downshift manually using the shift paddles on the steering wheel if you'd like even more control over gear selection.

What comes between you and the road.

The M-Class wheels were designed with the same philosophy as the rest of this inspired vehicle. Style, substance and safety are the cornerstones of Mercedes-Benz, and none of these attributes were spared while developing these impressive wheels.



19" 5 twin-spoke wheels.



20" AMG 5 spoke wheels¹.

¹Available as part of the Sport Package.

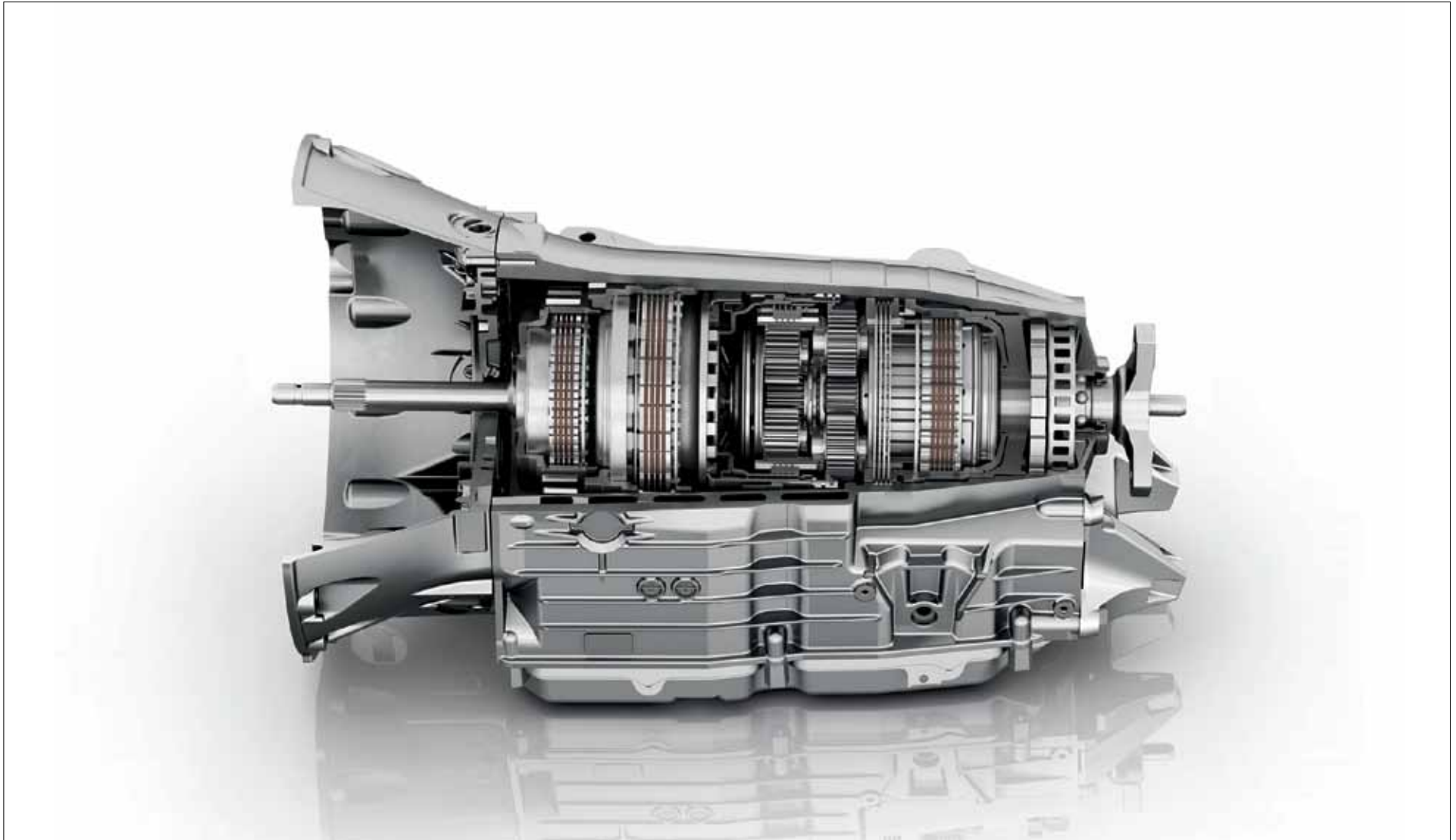

The 7G TRONIC PLUS automatic transmission; one of over 18 million automatic transmissions produced in a period spanning more than 50 years.

Increased performance. Reduced emissions.

Performance meets fuel economy. Luxury meets responsibility. At Mercedes-Benz, we don't believe in compromise. Our BlueEFFICIENCY philosophy ensures that environmental responsibility plays a major role in all we do. We do this at all levels of vehicle development and production – and therefore take a comprehensive approach to all the potential factors relating to drive systems, lightweight construction, energy management and fuels. The new 3.0 L Turbo V6 Diesel Engine on the ML 350 BlueTEC 4MATIC™ is no exception. This engine has been revised for greater power and efficiency, delivering an impressive 240 hp and 455 lb-ft of torque. Seamless performance and rigorous fuel economy allow the ML 350 BlueTEC 4MATIC™ to meet even the strictest emission regulations.

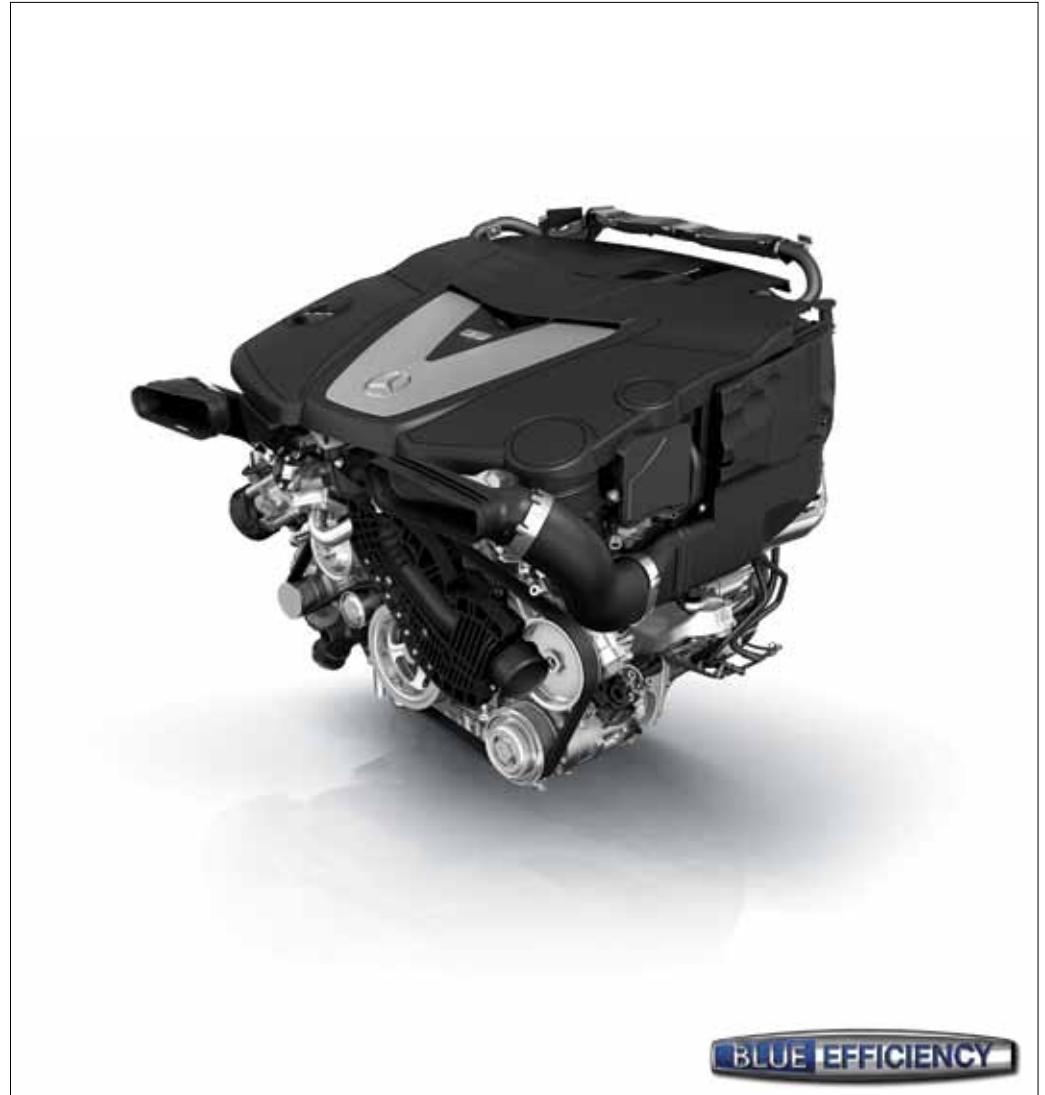

3.0 L Turbo V6 Diesel Engine.

Permanent confidence. Relentless control.

Our 4MATIC™ permanent all-wheel drive system gives you excellent control over your M-Class, for complete confidence no matter what the season or road conditions. It is always engaged, sending torque to each wheel independently and ensuring optimal traction and control. 4MATIC™ is aided by our 4-wheel Electronic Traction System (4ETS). 4ETS monitors each wheel for the first sign of wheel slip. It then individually brakes the slipping wheels to maintain the perfect balance of power and traction. By continuously ensuring that power goes only to the wheels with grip, 4ETS can help keep you moving, even if only one wheel has traction.



4MATIC™
CONTROL

ML 350 BlueTEC 4MATIC™.

Safety should never be left to chance.

The M-Class's extremely sturdy passenger cage protects occupants by way of energy-absorbing front-end, reinforced doors, extended crumple zones, and an elevated ride position. The optional Passive Blind Spot Assist monitors vehicles around you when travelling over 30 km/h¹. If a vehicle remains in your blind spot for more than 1.5 seconds, a warning triangle appears on the exterior side mirror. The Electronic Stability Program (ESP®) enhances control by monitoring your steering and braking, making instantaneous adjustments if it senses loss of control or stability. Seatbelts feature Emergency Tensioning Devices (ETDs) to help remove seatbelt slack in more severe front or rear impacts. Rest assured, driving an M-Class means driving protected.



DISTRONIC PLUS reduces the chance of rear end collisions by automatically braking in the event of danger.



Blind Spot Assist alerts the driver if it identifies a risk of a collision while the vehicle is changing lanes.



The energy-absorbing crumple zones in the front and rear sections, an extremely robust safety passenger cell, and the doors with special reinforcing elements form an effective defensive barrier in an emergency.

Dressed for the occasion.

The finishing touches can mean the difference between a work of art and a true masterpiece. Whichever colour you opt for, you've made the right choice. Because with a selection of paint finishes benefiting from an extra scratch-resistant clear coat, your M-Class is less susceptible not only to scratches, but also to sunlight, temperature variations, dust and soot.



ARTICO¹
 Black/Black
 Almond Beige/Mocha Brown
 Alpaca Grey/Reef Grey

LEATHER²
 Black/Black
 Tobacco Brown/Black
 Almond Beige/Black
 Alpaca Grey/Black

SOLID

Black	●	●	●	●	●	●	●
Calcite White	●	●	-	●	●	●	-

METALLIC

Obsidian Black	●	●	●	●	●	●	●
Tanzanite Blue	●	●	●	●	●	●	●
Tenorite Grey	●	○	●	●	●	○	●
Iridium Silver	●	-	●	●	●	-	●
Palladium Silver	●	-	●	●	●	-	●
Pearl Beige	●	●	-	●	-	●	-
Citrine Brown	●	●	-	●	-	●	-
Diamond White	●	●	-	●	●	●	-

● Recommended combination ○ Possible combination - Not available

SOLID

METALLIC (OPTIONAL)

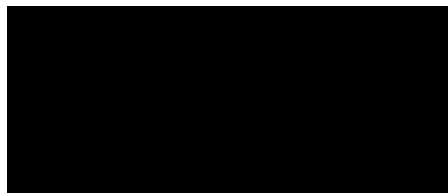

040 Black



197 Obsidian Black



775 Iridium Silver

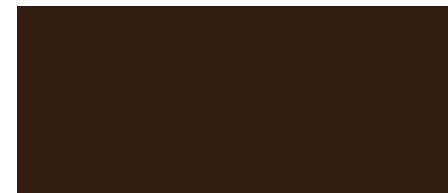

796 Citrine Brown



650 Calcite White



359 Tanzanite Blue



792 Palladium Silver

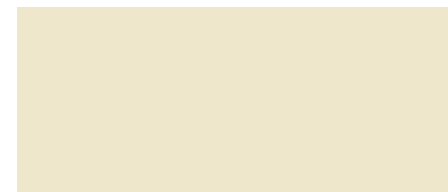

799 Diamond White



755 Tenorite Grey



794 Pearl Beige

ARTICO¹



101 Black/Black

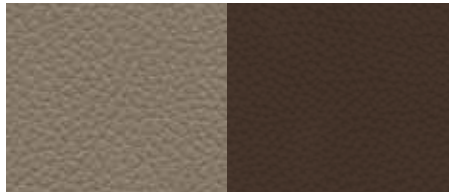

105 Almond Beige/Mocha Brown



108 Alpaca Grey/Reef Grey

LEATHER²



201 Black/Black



254 Tobacco Brown/Black

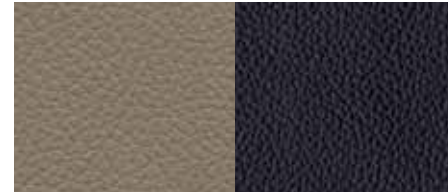

255 Almond Beige/Black



258 Alpaca Grey/Black

¹Standard on the ML 350 4MATIC™ and the ML 350 BlueTEC 4MATIC™. ²Available as part of an option package on the ML 350 4MATIC™ and the ML 350 BlueTEC 4MATIC™.

TRIM



729 Anthracite Poplar Wood



H09 Brown Ash Wood (open-pore)



731 Burl Walnut Wood

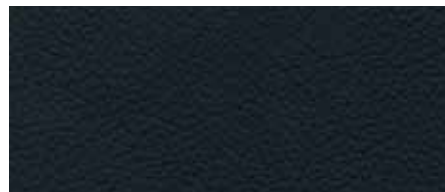

W69 *designo* Piano Black Lacquer Wood

INDIVIDUAL EQUIPMENT

TRANSMISSION

7G-TRONIC PLUS automatic transmission

TRACTION/STABILITY

4MATIC™ permanent all-wheel drive with 4ETS

Electronic Stability Program (ESP®) including ABS and traction control

Brake Assist (BAS)

AIRMATIC air suspension with Adaptive Damping System (ADS)

Downhill Speed Regulation (DSR)

AUDIO/VISUAL/COMMUNICATION

COMAND without navigation

COMAND APS with HDD navigation & DVD player

harman/kardon® LOGIC7® surround sound system

SIRIUS Satellite Radio¹

Rear Seat Entertainment System

Bluetooth connectivity

Media interface

EXTERIOR

19" 5 twin-spoke wheels

20" AMG 5-spoke wheels

AMG styling package

Exterior power folding mirrors

Auto dimming mirrors (rearview & driver's side)

Heated windshield washer system

Active bi-xenon headlamps

Adaptive Highbeam Assist (AHA)

ML 350 4MATIC™

ML 350 BlueTEC 4MATIC™

▲

▲

▲

▲

▲

▲

▲

▲

○

○

▲

▲

▲

▲

○

○

○

○

▲

▲

△

△

▲

▲

○

○

▲

▲

○

○

▲

▲

▲

▲

▲

▲

▲

▲

○

○

○

○

INDIVIDUAL EQUIPMENT

EXTERIOR CONTINUED

Headlamp washers

Aluminum running boards

Trailer hitch

INTERIOR

Climate comfort front seats

Power adjustable front seats

Power lumbar support (Driver's side)

Memory package with power steering column

Wood/leather steering wheel

Heated front seats

Heated leather covered steering wheel with telescopic steering adjustment

THERMATIC automatic climate control

Illuminated visor vanity mirrors

Sliding glass sunroof with pop-up

Panoramic sunroof

Heated rear seats

Privacy glass

Ambient lighting with 3 colour settings

CONVENIENCE

Integrated garage door opener

KEYLESS-GO

Rear view camera

SmartKey with panic button

ML 350 4MATIC™

ML 350 BlueTEC 4MATIC™

○

○

△

△

△

△

△

△

▲

▲

▲

▲

▲

▲

△

△

▲

▲

▲

▲

▲

▲

▲

▲

▲

▲

○

○

○

○

▲

▲

▲

▲

▲

▲

○

○

○

○

▲

▲

INDIVIDUAL EQUIPMENT

CONVENIENCE CONTINUED

EASY-PACK power tailgate

EASY-PACK load securing kit

115V power socket

SAFETY

Dual stage front airbags, front pelvic airbags, driver's knee airbag, head protection curtain airbags

Side airbags - rear

Seatbelts with belt force limiters and emergency tensioning device (ETD)

TeleAid emergency calling system²

ATTENTION ASSIST

DISTRONIC PLUS with PRE-SAFE[®] Brake

PARKTRONIC with Active Parking Assist

Anti-theft alarm system

Active Blind Spot Assist

Passive Blind Spot Assist

Active Lane Keeping Assist

Passive Lane Keeping Assist

Tire Pressure Loss Warning System

Electric parking brake

ML 350 4MATIC™

ML 350 BlueTEC 4MATIC™

○ ○

△ △

△ △

▲ ▲

▲ ▲

▲ ▲

△ △

▲ ▲

○ ○

○ ○

▲ ▲

○ ○

○ ○

○ ○

○ ○

▲ ▲

▲ ▲

EQUIPMENT PACKAGES

PREMIUM PACKAGE:

Rear view camera, Panoramic sunroof, PARKTRONIC with Active Parking Assist, Heated rear seats, KEYLESS-GO, EASY-PACK power tailgate, Media interface, COMAND APS with HDD navigation & DVD player, harman/kardon[®] LOGIC7[®] surround sound system.

SPORT PACKAGE:

Adaptive damping system (ADS), AIRMATIC air suspension, 20" AMG 5-spoke wheels.

LEATHER PACKAGE:

Leather upholstery, ARTICO leather dashboard.

ADVANCED DRIVING ASSISTANCE PACKAGE:

DISTRONIC PLUS, Active Blind Spot Assist, Active Lane Keeping Assist.

DRIVING ASSISTANCE PACKAGE:

Passive Blind Spot Assist, Passive Lane Keeping Assist.

BI-XENON HEADLAMP PACKAGE:

Headlamp washers, Adaptive highbeam assist (AHA), Active Bi-xenon headlamps, Lighting package.

ML 350 4MATIC™

ML 350 BlueTEC 4MATIC™

△ △

△ △

△ △

△ △

△ △

△ △

▲ Standard equipment △ Optional equipment ○ Optional as part of a package

The final touches.

Added nuances and unique refinements are just the things to make your M-Class a distinctively richer driving experience. Mercedes-Benz Genuine Accessories are designed and built to the highest standards for engineering, quality, style and function.



Load Sill Protector

Conveniently folds together to stay out of the way. When needed, roll out and protect your rear bumper from scratches and chips.



Chrome Hood Grill Inserts

Add an elegant finishing touch to the standard chrome trim elements.



Running Board Light Kit

Smart modern entrance illumination that makes getting into the vehicle at night safe and comfortable.



Door Chrome Cups

Exclusive chrome design, protects against scratches and helps round out the vehicles chrome package to perfection.

Technical data:

	ML 350 BlueTEC 4MATIC™	ML 350 4MATIC™
Engine type	24V DOHC V6	24V DOHC V6
Total displacement	2,987 cm ³	3,498 cm ³
Net power	240 hp @ 3,600 rpm	302 hp @ 6,500 rpm
Net torque	455 lb-ft @ 1,600-2,400 rpm	273 lb-ft @ 3,500-5,250 rpm
Acceleration ¹ , 0-100 km/h	7.4 seconds	7.6 seconds
Approximate top speed ²	210 km/h	210 km/h
Tires, front rear	255/50 R 19 255/50 R 19	255/50 R 19 255/50 R 19
Fuel economy ³ , city/highway estimate	10.5-7.3 L/100 km	12.3 – 8.9 L/100 km
Fuel tank capacity	93 litres	93 litres
Fuel requirement	Diesel	Premium unleaded
Dimensions ⁴		
Wheelbase	2,915 mm	2,915 mm
Overall length	4,804 mm	4,804 mm
Overall height	1,796 mm	1,796 mm
Overall width – Mirrors Extended	2,141 mm	2,141 mm
Curb weight	2,175 kg	2,130 kg
Cargo capacity	690 - 2010 litres	690 - 2010 litres

¹Stated rates of acceleration are based on the manufacturer's track results and may vary depending upon model, environmental and road surface conditions, driving style, elevation and vehicle load. ²Electronically limited. ³These estimates are based on Transport Canada testing methods. The actual fuel consumption of these vehicles may vary. Refer to the Fuel Consumption Guide. ⁴With standard equipment.

A passion for things done right.

A passion for craftsmanship and attention to detail – it’s what you’d expect from Mercedes-Benz. It drives us to set new standards in design, performance, comfort and safety, and to continually build on the legendary traditions of Mercedes-Benz, and to provide you with an ownership experience that includes the valuable benefits described below.

24-hour Roadside Assistance

During the basic warranty coverage of 48 months and the time duration of the optional Extended Limited Warranty, Mercedes-Benz Roadside Assistance will be at your service. We’ll bring you some gas, replace a flat tire with your spare, or jumpstart your car. In the event of a mechanical breakdown, if attempts by our Roadside Assistance technician have not made your vehicle safely operable, towing service will be provided to the nearest Mercedes-Benz dealership. Assistance is available 24 hours a day, every day, to anyone driving a Mercedes-Benz anywhere in Canada or the continental U.S.¹

Wear and tear period

The following parts listed are covered for wear and tear during the first 24 months or 40,000 km, whichever comes first. Brake pads, brake discs, brake pad wear sensors and light bulbs.

Mercedes-Benz warranties

The Mercedes-Benz New Vehicle Limited Warranty covers defects in materials or workmanship for 48 months or 80,000 km, whichever comes first. To widen your window of confidence, you can opt for a Mercedes-Benz Extended Limited Warranty as well.²

Customer service

Owning a Mercedes-Benz means that when you have a question, we’re here to help. Customer Service is open from 9 a.m. to 5 p.m. EST, Monday through Friday, and is staffed with knowledgeable Mercedes-Benz experts who can talk you through the finer points of working your car’s audio system – or even assist you in locating the nearest Mercedes-Benz dealership. Just call 1-800-387-0100. It’s that simple.

Trip interruption reimbursement

If a breakdown covered by your New Vehicle Limited Warranty or optional Extended Limited Warranty occurs more than 80 km from your home, leaves your Mercedes-Benz vehicle inoperable or unsafe to drive, and requires overnight repairs, we’ve got you covered. You will be reimbursed up to \$500 for hotel accommodations and up to \$600 for alternative travel expenses per incident while your car is being repaired at an authorized Mercedes-Benz dealership.

¹Vehicle must be accessible from main roads. Roadside Assistance may involve charges for parts, service and towing. Depending on the circumstances, these services may be provided by an outside service provider, courtesy of Mercedes-Benz Roadside Assistance. For full details of the Roadside Assistance Program, please see your dealer. ²Please see your dealer for warranty details as well as for terms, conditions and pricing for extended warranty options.



Mercedes-Benz is virtually yours.

Visit mercedes-benz.ca and open an online window to Mercedes-Benz Canada. Revel in the incredible photography of our vehicles and get a visceral impression of what it would be like to see yourself behind the wheel. Access information about any of our vehicles, including financing and leasing options, upcoming models, and configure your dream Mercedes online. Our website also offers details about the Mercedes-Benz Extended Limited Warranty, vehicle ownership, and much more on the fascinating story behind one of the world's most recognizable brands.

To be continued. With a test drive.

Nowhere is your M-Class so convincing as on the road. It's only there that you can fully experience the superior handling and power that makes this car so special. Feel the engine move you forward, and watch your heart rate rise with the speedometer. That unique feeling in your stomach cannot be put down on paper. That's why we would like to invite you in for a test drive at your local Mercedes-Benz dealer. Reserve your appointment today, or visit mercedes-benz.ca. We look forward to seeing you.

© 2011 Mercedes-Benz Canada Inc.

All illustrations and specifications contained in this brochure are based on the latest product information available at the time of publication. Mercedes-Benz Canada reserves the right to make changes at any time, without notice, in colours, materials, equipment, specifications and models. Any inaccuracies in colours shown are due to reproduction variations of the printing process. Some vehicles may be shown with non-Canadian equipment. Some vehicles may be shown without side marker lights. Some vehicles are shown with optional equipment available at extra cost. Some optional equipment may not be available on all models. For current information regarding the range of models, standard features, optional equipment and/or colours available in Canada and their pricing, contact your nearest authorized Mercedes-Benz dealer or visit mercedes-benz.ca. harman/kardon® and LOGIC7® are registered trademarks of Harman International Industries Inc. iPod® is a registered trademark of Apple Computer, Inc.

Printed in Canada
MBC-11-M12-11400E

Mercedes-Benz Canada Inc. 98 Vanderhoof Avenue, Toronto, Ontario M4G 4C9
1-800-387-0100

www.mercedes-benz.ca

