

The all-new 2012 C-Class Sedan



Mercedes-Benz
The best or nothing.



C 350 4MATIC™ Sedan.



Performance with a standing ovation.

The all-new 2012 C-Class Sedan embodies refinement with an edge. With plenty of performance power, it's as exciting to drive as it is to sit inside; high quality materials and strict attention to detail is apparent the moment you step in. And with safety enhancements like the standard ATTENTION ASSIST and the optional Passive Lane Keeping Assist and Blind Spot Assist, the all-new 2012 C-Class has proven itself the most refined sport sedan yet.

The C-Class Sedan

DESIGN	2
ENTERTAINMENT & COMMUNICATION	8
4MATIC™	10
AGILITY	12
SAFETY	14
AMG	16
COLOURS & MATERIALS	18
EQUIPMENT LISTING	24
ACCESSORIES & TECHNICAL DATA	26
OWNERSHIP, WEBSITE & TEST DRIVE	28



Perfect form.

Attention to detail is central to Mercedes-Benz; and it is evident within the 2012 C-Class Sedan. With its AMG styled exterior, active bi-xenon headlamps with LED turn signal indicators, striking new LED tail lamps, a newly contoured front end with LED daytime running lights, and rear bumper with a newly designed diffuser – it's an expression of refined athleticism, and a true work of art.



C 350 4MATIC™ Sedan.



Refined around the edges.

Once you settle into the C-Class Sedan, you'll never want to leave. The serene comfort of the interior combined with a full colour instrument display, new gearshift knob, and newly designed steering wheel with a flat bottom¹ awaits your enjoyment. A large swath of wood sweeps across the dash and boasts pure luxury, creating a balanced harmony like no other.

Though, a simple turn of the key quickly reminds you of the vehicle's athletic nature.

¹Flat bottom steering wheel only available on the C 300 4MATIC™ and C 350 models.



C 350 4MATIC™ Sedan interior.



C 350 4MATIC™ Sedan.



Shifting the gears of perception.

Over 125 years of innovation has been kind to the C-Class Sedan. It boasts new engines, including the 201 hp direct-injection 4-cylinder turbo in the C 250 and the 302 hp direct-injection V6 in the C 350 and C 350 4MATIC™ – both exhibiting improved fuel economy and increasing horsepower. An all-new full colour instrument cluster puts complete control at your fingertips. The COMAND Navigation unit with 7" display ensures you always know where you're going, while the CD/DVD player with an SD card slot will keep you and your passengers entertained along the way.



C 350 4MATIC™ Sedan interior.

The image shows the interior of a Mercedes-Benz C-Class Sedan, focusing on the dashboard and center console. The dashboard is dark with a silver trim piece. A navigation screen is visible on the left side of the dashboard, displaying a map with a highlighted route. The center console has a silver air vent and a control panel with various buttons and a rotary dial. The overall lighting is dim, suggesting a nighttime setting.

Get the show on the road.

Though just driving the C-Class Sedan is thrilling in itself, a number of other features provide you with entertainment while on the road. The MP3-compatible CD/DVD player features USB, iPod®, and auxiliary inputs – providing the confidence of versatility and adaptability. Additionally, the optional Media interface syncs with your iPod® to let you browse artist album artwork in similar fashion to your iPod® itself.

Added Bluetooth compatibility, with audio streaming capability, completes this innovative and trend setting entertainment and communication system.

Owens the road as easily as it does attention.

With our award-winning 4MATIC™ permanent all-wheel drive system delivering optimal traction regardless of road conditions, the C-Class sedan knows no boundaries. 4MATIC™ incorporates the 4-wheel Electronic Traction System (4ETS), monitoring each wheel for slippage, and ensures that power is transferred to the wheels with grip. 4MATIC™ will keep you going, even if only one wheel has traction. The C 350 4MATIC™ delivers the outstanding control of all-wheel drive without sacrificing true sport driving enjoyment. Sharp steering and the balanced feel of a rear-wheel drive vehicle are retained, making the C 350 4MATIC™ a joy to drive in any season.





C 350 4MATIC™ Sedan.

It never misses a beat.

At the heart of the C-Class Sedan is one of two powerful new engines. Powering the C 250 is the new direct-injection 4 cylinder turbo, with an impressive 201 horsepower and 228 lb-ft of torque. The C 350 adds even more power with the new direct-injection V6 with 302 horsepower and 273 lb-ft of torque, swiftly accelerating from 0-100 km/h in just 6 seconds.

Keeping track of your bearings.

The C-Class Sedan's AGILITY CONTROL handles the delicate balance between sport and refinement. Its selective damping system features dampers at each wheel, which constantly adjust between harder and softer absorption depending on the road conditions. The result is a noticeably smoother ride, even when the road

is not. The Dynamic Handling Package – a standard on the C 350 – completely transforms the vehicle's driving dynamics with a simple push of a button. Switching from 'comfort' to 'sport' mode, drivers will notice a throttle that responds more eagerly, quicker gear changes, more direct steering and increased chassis firmness for superior agility and handling.

What comes between you and the road.

The C-Class Sedan wheel program is designed with the same philosophy as the rest of this inspired vehicle. Style, substance and safety are the cornerstones of Mercedes-Benz, and none of them were spared while developing these impressive wheels.



16" 7 twin-spoke wheels¹.



17" AMG 5 twin-spoke wheels (all-season performance tires)⁵.



17" 5 twin-spoke wheels².



18" AMG 5 twin-spoke wheels (performance tires)⁶.



17" 5 twin-spoke wheels³.



18" AMG 5 twin-spoke wheels (all-season performance tires)⁷.



18" AMG 7-spoke wheels⁴.



19" AMG multi-spoke wheels⁸.

¹Standard on the C 250 and C 250 4MATIC™. Not available on all other models. ²Standard on the C 300 4MATIC™. Not available on all other models. ³Available as a part of the Sport Package on the C 250 and C 250 4MATIC™. Not available on all other models. ⁴Standard on the C 350 and C 350 4MATIC™. Not available on all other models. ⁵Available as a standalone option on the C 300 4MATIC™. Not available on all other models. ⁶Standard on the C 63 AMG. Not available on all other models. ⁷Available as a standalone option on the C 350 and C 350 4MATIC™. Not available on all other models. ⁸Available as a standalone option on the C 63 AMG. Not available on all other models.

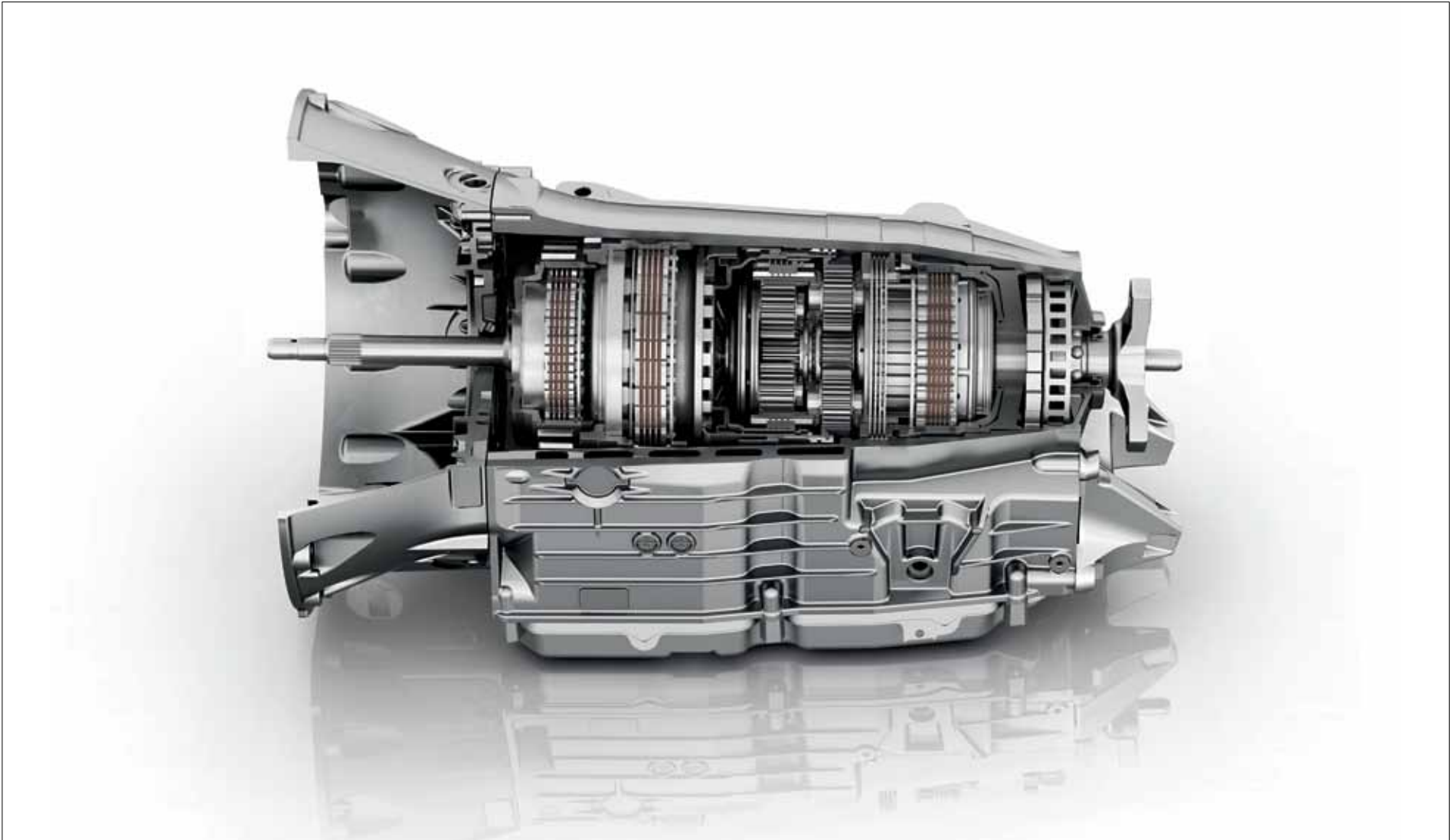

The 7G-TRONIC automatic transmission; one of over 18 million automatic transmissions produced in a period spanning more than 50 years.

Safety should never be left to chance.

The 'integral safety concept' from Mercedes-Benz is the guiding force behind a series of linked technologies that come into play in the critical moments before, during and after an accident. On the C-Class Sedan, the available Driving Assistance Package provides an even greater pre-empt against danger. Passive Blind Spot Assist provides a visual warning if a vehicle is detected in the driver's blind spot, via a light-up caution triangle housed in the wing mirror. An audible warning is then provided if the driver tries to change lanes. Passive Lane Keeping Assist identifies when the driver is drifting out of a lane unintentionally. The driver is warned by means of a visual alert and by a vibration in

the steering wheel. When reversing with little room to spare, PARKTRONIC with Parking Guidance can assist by providing visual and audible signals to alert the driver when they're approaching obstacles. In the event of a collision, the TeleAid¹ emergency calling system automatically engages with the assistance of a live representative who can provide the critical assistance required.

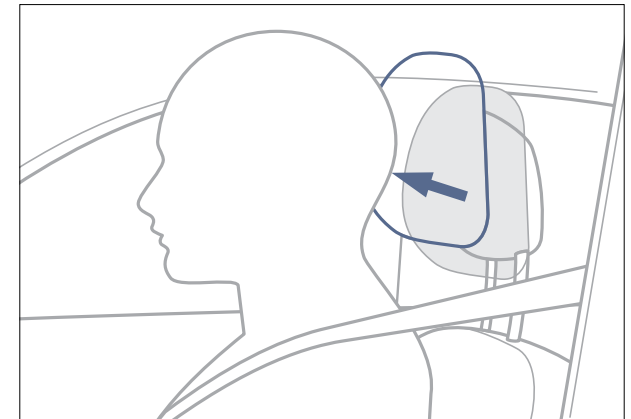

NECK-PRO head restraints.

¹Subscription is required for service to be active. TeleAid operates only where cellular and Global Positioning System coverage is available.

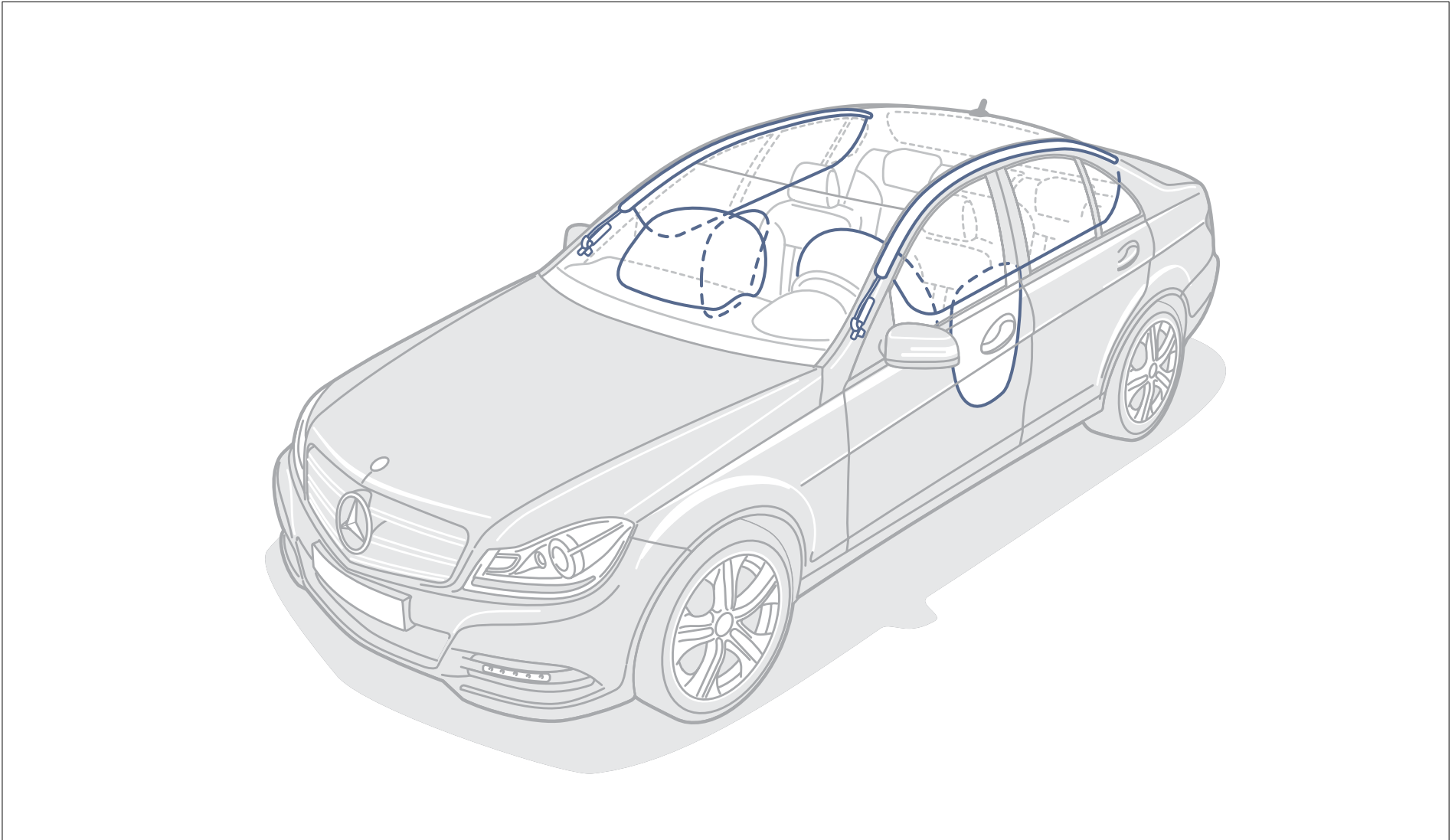

The energy-absorbing crumple zones in the front and rear sections, an extremely robust safety passenger cell, and the doors with special reinforcing elements form an effective defensive barrier in an emergency.



AMG

C 63 AMG in Iridium Silver.



Evoking the spirit of racing tradition.

From its 18" AMG 5 twin-spoke wheels to its new flat top and bottom steering wheel, every inch of the all-new Mercedes-Benz C 63 AMG has been carefully crafted for performance. Lightning fast acceleration and virtually seamless downshifting come compliments of the new AMG SPEEDSHIFT MCT 7-Speed automatic transmission's efficiencies. The AMG Performance Package adds 30 additional horsepower for a total of 481 hp and top speed of 280 km/h.¹ And with limited-slip differential and tire pressure monitoring, drivers can exploit its power with confidence. Incredible performance converges with modern design on its AMG trunk lid spoiler in carbon fibre and AMG carbon fibre mirror covers, proving confidence and character run deep within the C 63 AMG.



19" AMG multi spoke wheels.



AMG trunk lid spoiler in carbon fibre.

Dressed for the occasion.

The finishing touches can mean the difference between a work of art and a true masterpiece. Whichever colour you opt for, you've made the right choice. With a selection of paint finishes benefiting from an extra scratch-resistant clear coat, your C-Class is less susceptible not only to scratches, but also to sunlight, temperature variations, dust and soot.



ARTICO (TONE ON TONE) ¹	Black/Black	Almond Beige/Cashmere Beige	Alpaca Grey/Alpaca Grey	ARTICO (TONE ON BLACK) ¹	Black/Black	Alpaca Grey/Black	LEATHER (TONE ON BLACK) ²	Black/Black	Cappuccino/Black	Sahara Beige/Black	Alpaca Grey/Black	AMG PASSION LEATHER ³	Black/Black	Almond Beige/Mocha Brown	Alpaca Grey/Black	Alpaca Grey/Black	Almond Beige/Mocha Brown	Alpaca Grey/Black	Alpaca Grey/Black
------------------------------------	-------------	-----------------------------	-------------------------	-------------------------------------	-------------	-------------------	--------------------------------------	-------------	------------------	--------------------	-------------------	----------------------------------	-------------	--------------------------	-------------------	-------------------	--------------------------	-------------------	-------------------

SOLID

Black	●	●	●	●	●	●	●	●	●	●	●	●	●	●	●	●	●	●	●
Fire Opal	●	Δ	○	●	●	●	○	●	○	●	○	●	●	●	○	○	●	●	●
Calcite White	●	●	Δ	●	Δ	●	●	●	●	Δ	●	●	●	●	●	○	○	●	○
METALLIC PAINT																			
Obsidian Black	●	●	●	●	●	●	●	●	●	●	●	●	●	●	●	●	●	●	●
Magnetite Black	●	○	●	●	●	●	●	●	●	●	●	●	●	●	●	●	●	●	●
Iridium Silver	●	Δ	●	●	●	●	○	Δ	●	●	●	●	●	Δ	Δ	●	●	○	○
Alabandite Green	○	●	●	○	●	○	●	●	●	●	●	○	●	○	Δ	Δ	○	Δ	○
Palladium Silver	●	Δ	●	●	●	●	●	●	●	●	●	●	●	Δ	Δ	●	●	○	○
Pearl Beige	Δ	●	Δ	Δ	Δ	Δ	○	●	Δ	●	●	●	●	●	●	○	○	○	○
Cavansite Blue	○	●	○	○	●	○	●	●	●	●	●	●	●	●	Δ	Δ	●	●	●

● Recommended combination

○ Possible combination

Δ Not a recommended combination

¹Available on the C 250, C 250 4MATIC™, 300 4MATIC™, C 350 and the C 350 4MATIC™. Not available on the C 63 AMG. ²Available on the C 300 4MATIC™, C 350 and C 350 4MATIC™. Not available on the C 250 and C 250 4MATIC™ and the C 63 AMG. ³Available only on the C 63 AMG. Not available on C 250, C 300 and C 350 models.

SOLID

METALLIC (OPTIONAL)

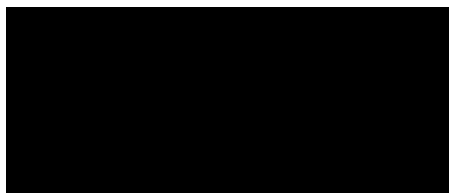

040 Black



197 Obsidian Black



779 Alabandite Green



890 Cavansite Blue



590 Fire Opal

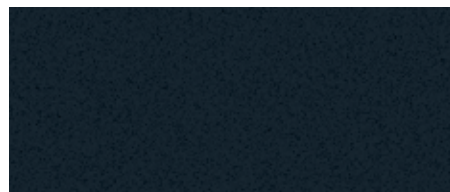

183 Magnetite Black

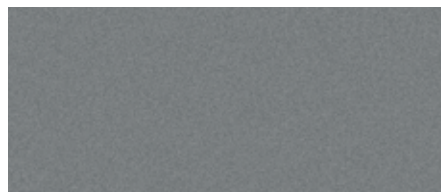

792 Palladium Silver

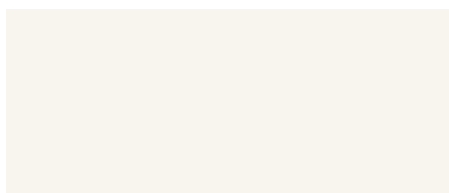

650 Calcite White



775 Iridium Silver



794 Pearl Beige

ARTICO (TONE ON TONE)¹



121 Black/Black



125 Almond Beige/Cashmere Beige

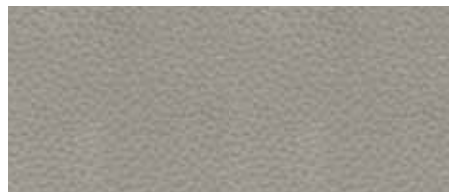

125 Alpaca Grey/Alpaca Grey

ARTICO (TONE ON BLACK)¹



121 Black/Black



128 Alpaca Grey/Black

LEATHER (TONE ON BLACK)²



221 Black/Black



224 Cappucino/Black

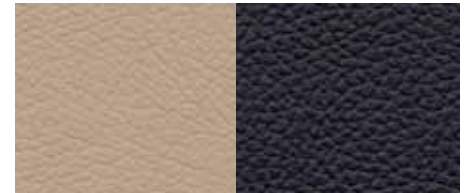

235 Sahara Beige/Black



228 Alpaca Grey/Black

¹Available on the C 250, C 250 4MATIC™, 300 4MATIC™, C 350 and the C 350 4MATIC™. Not available on the C 63 AMG. ²Available on the C 300 4MATIC™, C 350 and C 350 4MATIC™. Not available on the C 250 and C 250 4MATIC™ and the C 63 AMG. ³Available only on the C 63 AMG. Not available on C 250, C 300 and C 350 models. ⁴Standard on the C 250 and C 350 Sedan models. ⁵Standard on the C 300 4MATIC™, C 350 models and the C 63 AMG. ⁶Available as part of a standalone option on all models. ⁷Available only on the C 63 AMG as part of the AMG Performance Package Plus.

AMG *designo* NAPPA LEATHER³

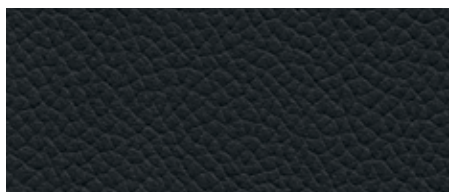

X11 Black - Single Tone

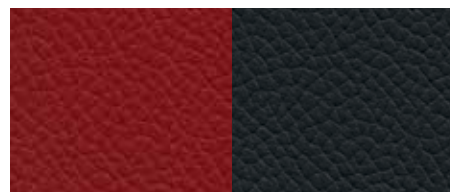

X83 Classic Red/Black - Two Tone

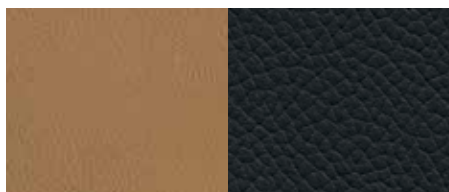

X10 Sand/Black - Single Tone

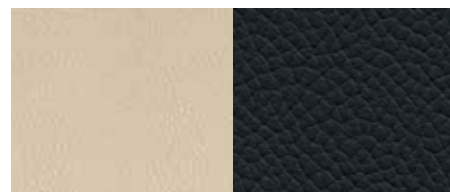

X27 Porcelain/Black - Single Tone

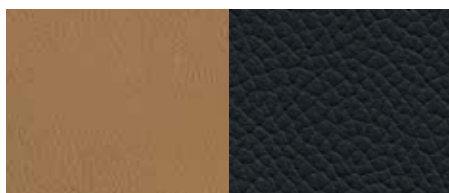

X77 Sand/Black - Two Tone

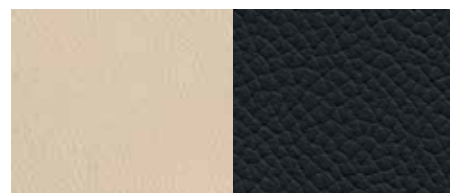

X87 Porcelain/Black - Two Tone

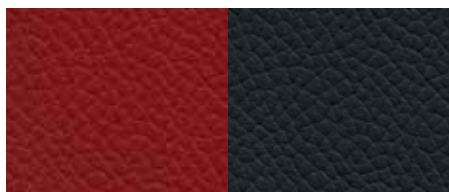

X17 Classic Red/Black - Single Tone

TRIM



731 Burl Walnut Wood Trim⁴



H06 Ash Olive Wood (Matte)⁶

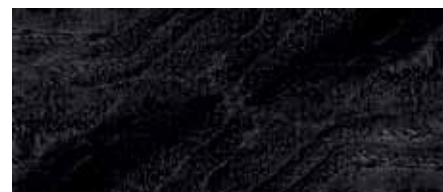

736 Dark Ash Wood⁵



H73 AMG Carbon Fibre Trim⁷



739 Aluminium⁶

designo.

Exclusive paints. Fine cut leathers. Carefully crafted trims. Consider these the finishing touches of an automotive masterpiece. Made from only the highest quality materials, *designo* options add a whole new dimension to the new C 63 AMG's awe-inspiring design. Fitted as standard on the C 63 AMG, *designo* interior options result in a very attractive interior and compliment this exceptional vehicle with a character as distinguished as your own.

Visit mercedes-benz.ca/designo for additional details and configurator options.



C 63 AMG interior adorned in *designo* leather upholstery.



Exclusive appointments provide an unmatched interior character.

INDIVIDUAL EQUIPMENT

CONVENIENCE

Direct steering
PARKTRONIC with active parking guidance
Integrated garage door opener
Cruise control
SmartKey remote with panic button
KEYLESS-GO
115V power socket

SAFETY

Seatbelt tensioners with belt force limiters and front seatbelt height adjustment
Dual-stage front airbags, front side airbags, side window curtain airbags (front and rear), driver's knee airbag, pelvic airbags
NECK-PRO headrests
Anti-theft alarm system
First aid kit
ATTENTION ASSIST
TeleAid emergency calling system ²
Tire pressure loss warning system
Tire pressure monitoring system
Passive Lane Keeping Assist
Passive Blind Spot Assist
Hill start assist

EQUIPMENT PACKAGES

C 250 PREMIUM PACKAGE: Split folding rear seats, Sliding glass sunroof with pop-up, Heated front seats.

C 250 COMAND NAVIGATION PACKAGE: Integrated garage door opener, Electronic compass, Auto dimming mirrors (rearview & driver's side), LINGUATRONIC voice control, Exterior power folding mirrors, COMAND APS with HDD navigation & DVD player.

	C 250 Sedan	C 250 4MATIC™ Sedan	C 300 4MATIC™ Sedan	C 350 Sedan	C 350 4MATIC™ Sedan	C 63 AMG
Direct steering	-	-	-	▲	-	▲
PARKTRONIC with active parking guidance	-	-	○	○	○	○
Integrated garage door opener	○	○	○	▲	▲	▲
Cruise control	▲	▲	▲	▲	▲	▲
SmartKey remote with panic button	▲	▲	▲	▲	▲	▲
KEYLESS-GO	-	-	○	○	○	○
115V power socket	Δ	Δ	○	○	○	○
Seatbelt tensioners with belt force limiters and front seatbelt height adjustment	▲	▲	▲	▲	▲	▲
Dual-stage front airbags, front side airbags, side window curtain airbags (front and rear), driver's knee airbag, pelvic airbags	▲	▲	▲	▲	▲	▲
NECK-PRO headrests	▲	▲	▲	▲	▲	▲
Anti-theft alarm system	▲	▲	▲	▲	▲	▲
First aid kit	▲	▲	▲	▲	▲	▲
ATTENTION ASSIST	▲	▲	▲	▲	▲	▲
TeleAid emergency calling system ²	Δ	Δ	Δ	Δ	Δ	Δ
Tire pressure loss warning system	▲	▲	▲	▲	▲	▲
Tire pressure monitoring system	-	-	-	-	-	○
Passive Lane Keeping Assist	-	-	○	○	○	○
Passive Blind Spot Assist	-	-	○	○	○	○
Hill start assist	▲	▲	▲	▲	▲	▲
C 250 PREMIUM PACKAGE	Δ	Δ	-	-	-	-
C 250 COMAND NAVIGATION PACKAGE	Δ	Δ	-	-	-	-

EQUIPMENT PACKAGES

C 250 SPORT PACKAGE: LED daytime running lights, Sport suspension, AMG styling package, AVANTGARDE Line, 17" 5 twin-spoke wheels.

C 300 4MATIC™ PREMIUM PACKAGE: Rear view camera, PARKTRONIC with parking guidance, Integrated garage door opener, Electronic compass, Panoramic sunroof, COMAND APS with HDD navigation & DVD player, Media interface

C 300 4MATIC™ CONVENIENCE PACKAGE: Memory package with power steering column, KEYLESS-GO, Power lumbar support, 115V power socket.

C 350 PREMIUM PACKAGE: Rear view camera, PARKTRONIC with parking guidance, LINGUATRONIC voice control, Panoramic sunroof, COMAND APS with HDD navigation & DVD player, Media interface, KEYLESS-GO, 115V power socket.

C 63 AMG PREMIUM PACKAGE: Rear view camera, PARKTRONIC with parking guidance, Passive Blind Spot Assist, Passive Lane Keeping Assist, LINGUATRONIC voice control, COMAND APS with HDD navigation & DVD player, harman/kardon® LOGIC7® surround sound system, KEYLESS-GO, 115V power socket. Driving Assistance Package.

ENTERTAINMENT PACKAGE: SIRIUS Satellite Radio¹, harman/kardon® LOGIC7® surround sound system.

DRIVING ASSISTANCE PACKAGE: Passive Blind Spot Assist, Passive Lane Keeping Assist.

PREMIUM REAR SEATING PACKAGE: Roller blinds for rear side windows, Rear window sunshade, THERMOTRONIC automatic climate control.

AMG PERFORMANCE PACKAGE PLUS: Additional horsepower, Limited-slip rear differential, Tire pressure monitoring system, AMG carbon fibre trim, AMG trunk lid spoiler in carbon fibre, Red brake calipers.

	C 250 Sedan	C 250 4MATIC™ Sedan	C 300 4MATIC™ Sedan	C 350 Sedan	C 350 4MATIC™ Sedan	C 63 AMG
C 250 SPORT PACKAGE	Δ	Δ	-	-	-	-
C 300 4MATIC™ PREMIUM PACKAGE	-	-	Δ	-	-	-
C 300 4MATIC™ CONVENIENCE PACKAGE	-	-	Δ	-	-	-
C 350 PREMIUM PACKAGE	-	-	-	Δ	Δ	-
C 63 AMG PREMIUM PACKAGE	-	-	-	-	-	Δ
ENTERTAINMENT PACKAGE	-	-	Δ	-	-	-
DRIVING ASSISTANCE PACKAGE	-	-	Δ	Δ	Δ	-
PREMIUM REAR SEATING PACKAGE	-	-	-	Δ	Δ	Δ
AMG PERFORMANCE PACKAGE PLUS	-	-	-	-	-	Δ

▲ Standard equipment Δ Optional equipment ○ Optional as part of a package - Not available

The final touches.

Added nuances and unique refinements are just the things to make your C-Class Sedan a distinctively richer driving experience. Mercedes-Benz accessories are designed and built to the highest standards for engineering, quality, style and function.



Rear Spoiler

Add this rear spoiler for a more athletic look for your C-Class, and watch as it subtly accentuates the trunk lines of your vehicle. Tailor-made of high-quality material for quick installation and a perfect fit. Comes primed, ready for painting.



Roof Rack Basic Carrier

Our basic carrier is an essential component for attaching a wide assortment of items to the top of your C-Class. After easy installation, you can securely attach and lock bicycles, ski and snowboard racks, or a cargo container (shown). (Racks and containers sold separately).



Illuminated Door Sill Panels

The white illuminated Mercedes-Benz lettering is activated every time you open the door to get in or out. These illuminated door sill panels, in ground stainless steel, are a further "highlight" of the C-Class.



Trunk Tray

Simple to clean, non-slip, and precision tailored to the load area, this odourless tray prevents loads from sliding around and protects the carpet from spills and dirt.

	C 250	C 250 4MATIC™	C 300 4MATIC™	C 350	C 350 4MATIC™	C 63 AMG
Engine type	16V DOHC I4 Turbo	24V DOHC V6	24V DOHC V6	24V DOHC V6	24V DOHC V6	32V DOHC V8
Total Displacement (cm ³)	1,796 cm ³	2,496 cm ³	2,996 cm ³	3,498 cm ³	3,498 cm ³	6,208 cm ³
Net power	201 hp @ 5,500 rpm	201 hp @ 6,100 rpm	228 hp @ 6,000 rpm	302 hp @ 6,500 rpm	302 hp @ 6,500 rpm	451 hp @ 6,800 rpm
Net torque	228 lb-ft @ 2,000 – 4,300 rpm	181 lb-ft @ 2,900 – 5,500 rpm	221 lb-ft @ 2,500 – 5,000 rpm	273 lb-ft @ 3,500 – 5,250 rpm	273 lb-ft @ 3,500 – 5,250 rpm	443 lb-ft. @ 5,000 rpm
Acceleration ¹ , 0–100 km/h	7.2 seconds	8.6 seconds	7.2 seconds	6.0 seconds	6.0 seconds	4.5 seconds
Approximate top speed ²	210 km/h	210 km/h	210 km/h	210 km/h	210 km/h	250 km/h
Tires, front rear	205/55 R 16 205/55 R 16	205/55 R 16 205/55 R 16	255/45 R 17 245/40 R 17	225/40 R 18 255/35 R 18	225/40 R 18 255/35 R 18	235/40 R 18 255/35 R 18
Fuel economy ³ , city/highway estimate	9.6-6.3 L/100 km	12.4-8.3 L/100 km	11.8-7.9 L/100 km	10.8-7.0 L/100 km	10.7-7.0 L/100 km	16-10.4 L/100 km
Fuel tank capacity	66 litres (8 litre reserve)	66 litres (8 litre reserve)	66 litres (8 litre reserve)	66 litres (8 litre reserve)	66 litres (8 litre reserve)	66 litres (8 litre reserve)
Fuel requirement	Premium unleaded	Premium unleaded	Premium unleaded	Premium unleaded	Premium unleaded	Premium unleaded
Dimensions ⁴						
Wheelbase	2,760 mm	2,760 mm	2,760 mm	2,760 mm	2,760 mm	2,760 mm
Overall length	4,591 mm	4,591 mm	4,591 mm	4,591 mm	4,591 mm	4,707 mm
Overall height	1,444 mm	1,444 mm	1,445 mm	1,448 mm	1,448 mm	1,433 mm
Overall width – Mirrors Extended	2,008 mm	2,008 mm	2,008 mm	2,008 mm	2,008 mm	2,008 mm
Curb weight	1,505 kg	1,690 kg	1,695 kg	1,610 kg	1,670 kg	1,730 kg
Luggage Capacity	475 litres	475 litres	475 litres	475 litres	475 litres	475 litres

¹Stated rates of acceleration are based on the manufacturer's track results and may vary depending upon model, environmental and road surface conditions, driving style, elevation and vehicle load. ²Electronically limited. ³These estimates are based on Transport Canada testing methods. Estimates for the C-Class Sedan are based on 7G-TRONIC models. The actual fuel consumption of these vehicles may vary. Refer to the Fuel Consumption Guide. ⁴With standard equipment.

A passion for things done right.

A passion for craftsmanship and attention to detail – it's what you'd expect from Mercedes-Benz, and it drives us to set new standards in design, performance, comfort and safety. To continually build on the legendary traditions of Mercedes-Benz, and to provide you with an ownership experience that includes the valuable benefits described below.

24-hour Roadside Assistance

During the basic warranty coverage of 48 months and the time duration of the optional Extended Limited Warranty, Mercedes-Benz Roadside Assistance will be at your service. We'll bring you some gas, replace a flat tire with your spare, or jumpstart your car. In the event of a mechanical breakdown, if attempts by our Roadside Assistance technician have not made your vehicle safely operable, towing service will be provided to the nearest Mercedes-Benz dealership. Assistance is available 24 hours a day, every day, to anyone driving a Mercedes-Benz anywhere in Canada or the continental U.S.¹

Wear and tear period

The following parts listed are covered for wear and tear during the first 24 months or 40,000 km, whichever comes first. Brake pads, brake discs, brake pad wear sensors and light bulbs.

Mercedes-Benz warranties

The Mercedes-Benz New Vehicle Limited Warranty covers defects in materials or workmanship for 48 months or 80,000 km, whichever comes first. To widen your window of confidence, you can opt for a Mercedes-Benz Extended Limited Warranty as well.²

Customer service

Owning a Mercedes-Benz means that when you have a question, we're here to help. Customer Service is open from 9 a.m. to 5 p.m. EST, Monday through Friday, and is staffed with knowledgeable Mercedes-Benz experts who can talk you through the finer points of working your car's audio system – or even assist you in locating the nearest Mercedes-Benz dealership. Just call 1-800-387-0100. It's that simple.

Trip interruption reimbursement

If a breakdown covered by your New Vehicle Limited Warranty or optional Extended Limited Warranty occurs more than 80 km from your home, leaves your Mercedes-Benz vehicle inoperable or unsafe to drive, and requires overnight repairs, we've got you covered. You will be reimbursed up to \$500 for hotel accommodations and up to \$600 for alternative travel expenses per incident while your car is being repaired at an authorized Mercedes-Benz dealership.

¹Vehicle must be accessible from main roads. Roadside Assistance may involve charges for parts, service and towing. Depending on the circumstances, these services may be provided by an outside service provider, courtesy of Mercedes-Benz Roadside Assistance. For full details of the Roadside Assistance Program, please see your dealer. ²Please see your dealer for warranty details as well as for terms, conditions and pricing for extended warranty options.



Mercedes-Benz is virtually yours.

Visit mercedes-benz.ca and open an online window to Mercedes-Benz Canada. Revel in the incredible photography of our vehicles and get a visceral impression of what it would be like to see yourself behind the wheel. Access information about any of our vehicles, including financing and leasing options, upcoming models, and configure your dream Mercedes online. Our website also offers details about the Mercedes-Benz Extended Limited Warranty, vehicle ownership, and much more on the fascinating story behind one of the world's most recognizable brands.

To be continued. With a test drive.

Nowhere is your C-Class so convincing as on the road. It's only there that you can fully experience the superior handling and power that makes this car so special. Feel the engine move you forward, and watch your heart rate rise with the speedometer. That unique feeling in your stomach cannot be put down on paper. That's why we would like to invite you in for a test drive at your local Mercedes-Benz dealer. Reserve your appointment today, or visit mercedes-benz.ca.

C 63 AMG.

© 2011 Mercedes-Benz Canada Inc.

All illustrations and specifications contained in this brochure are based on the latest product information available at the time of publication. Mercedes-Benz Canada reserves the right to make changes at any time, without notice, in colours, materials, equipment, specifications and models. Any inaccuracies in colours shown are due to reproduction variations of the printing process. Some vehicles may be shown with non-Canadian equipment. Some vehicles may be shown without side marker lights. Some vehicles are shown with optional equipment available at extra cost. Some optional equipment may not be available on all models. For current information regarding the range of models, standard features, optional equipment and/or colours available in Canada and their pricing, contact your nearest authorized Mercedes-Benz dealer or visit mercedes-benz.ca. harman/kardon® and LOGIC7® are registered trademarks of Harman International Industries Inc. iPod® is a registered trademark of Apple Computer, Inc.

Printed in Canada
MBC-11-CC12-37850E

Mercedes-Benz Canada Inc. 98 Vanderhoof Avenue, Toronto, Ontario M4G 4C9
1-800-387-0100

www.mercedes-benz.ca

