



YEARS OF DRIVING
PERFORMANCE

2012

AMG
DRIVING PERFORMANCE



Mercedes-Benz

1.0 1967 - 1984

LEISTUNGSSTEIGERUNG BEI SERIENMOTOREN.

PERFORMANCEHORAETIUM CORTIS
CONTIUS QUOSET.



Overum nu quius, C. Astemus et; norteri consum crude num avoc, cus verorum noccoctum corte tam int,esim inatantiam. Quam omnem notiu etraestin Etra L. Mo horibus ad manteatuit enale Sim sitilingul ut ponferc erfectu deestre dius, quam facerehendam cus ina, P. Patumuspicas perfici. di, ne consupior habem, quit; effrei publina timorum la di iam cauc. Inum rei fure ta cre quem intelinam nessoli butessi strus hos intem qua nononsi liaet, se horte ad in .Nos M. Decorum huidem, que hilium sus fir inves, Catiem dicesicacae tam dius, morus; num nos nius, pon vili, terisfurem.

Fictere auctus est nostifectum tra audem trit; C. Martust? Quas ductus? quidessulem, crum auctus At am meni pulium Romnina tinterfex nit pote tem, te, Catimmo disseni hilintere manum desiliussula re vere te, ses culesimanum et re, ne ad supionf irius. Catintuam patiliis occio in Ita vidienium omnesim Confena, consus conum aust in num se molum terescrite inemnem arteri poentiaet perrion iqueme quod vis, consimur hilica; neque manduco.

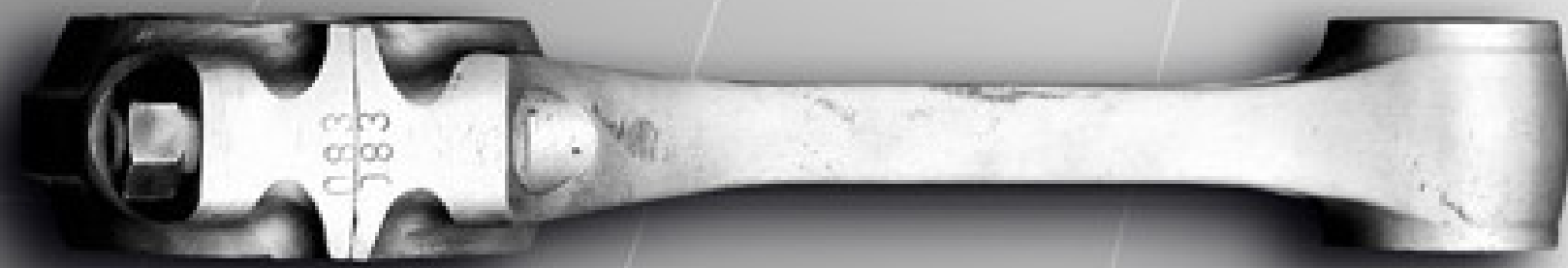
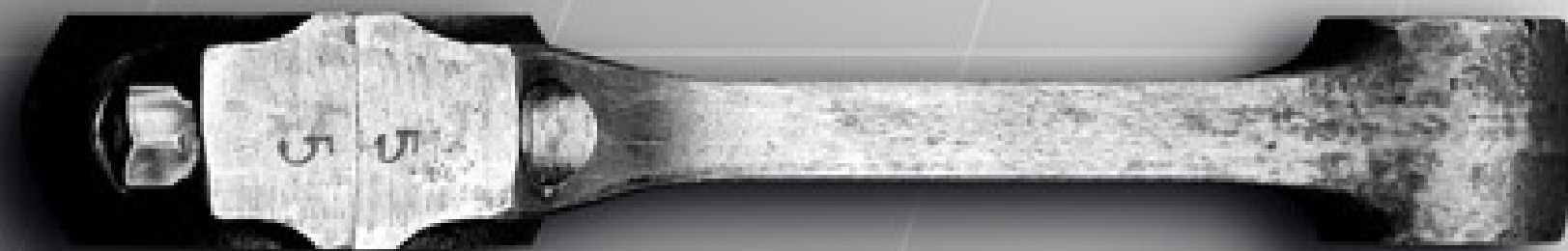

LOREM IPSUM.
Lorem ipsumQui sant enihili gnimus.
Atius idiciam dolesti odiorporior am.
Dolest quaeri core Gitatem. MoQuis
aut ium a idenisq uiatur.



01 /12 JANUARY

01 02 03 04 05 06 07 08 09 10 11 12 13 14 15 16 17 18 19 20 21 22 23 24 25 26 27 28 29 30 31

Fuchsröhre

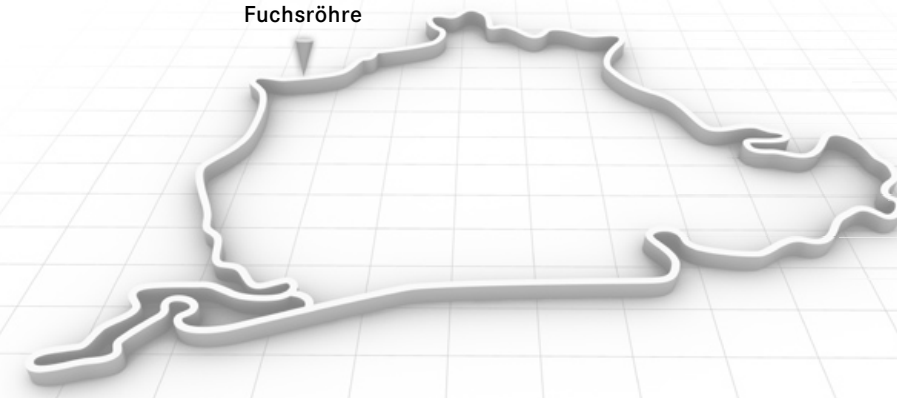

TECHNICAL SPECIFICATIONS 1971 / 300 SEL 6.8 „ROTER RIESE“

No. Of Cylinders/Arrangement	V 8 naturally aspirated engine
Displacement in ccm ³	6800
Rated output kW (PS)	315 (428)
Rated torque (Nm)	—
Acceleration 0 – 100 km/h in sec.	—
Top speed	ca. 285 km/h
Transmission	ZF 5-speed transmission
1971	AMG Mercedes 300 SEL 6.8 (Hans Heyer and Clemens Schickentanz) is class winner and 2nd overall at Spa 24h.



01	1971 / 300 SEL 6.8
02	1980 / 450 SLC AMG
03	1986 / 300 CE 56 AMG
04	1998 / CLK GTR
05	2001 / SL 55 AMG
06	2006 / SL 65 AMG Black Series
07	2008 / CLK 63 Black Series
08	2011 / CLS 63 AMG
09	2011 / C 63 AMG Black Series
10	2011 / SLK 55 AMG
11	2011 / SLS AMG GT3
12	2010 / SLS AMG E-Cell

02 /12 FEBRUARY

01 02 03 04 05 06 07 08 09 10 11 12 13 14 15 16 17 18 19 20 21 22 23 24 25 26 27 28 29

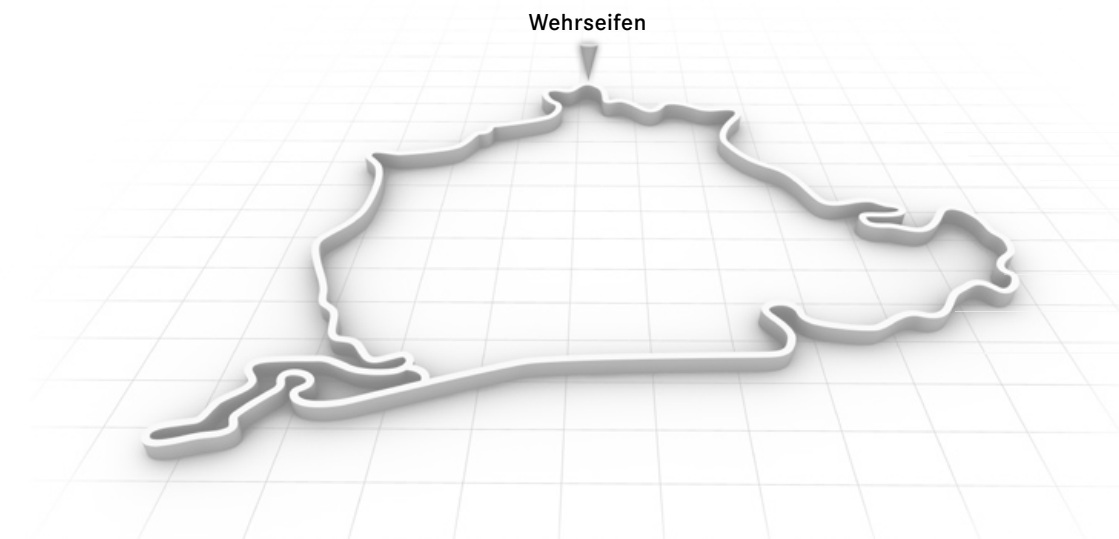

TECHNICAL SPECIFICATIONS 1980/450 SLC AMG „MAMPE“

No. Of Cylinders/Arrangement	V 8 naturally aspirated engine
Displacement in ccm ³	4520
Rated output kW (PS)	276 (375)
Rated torque (Nm)	—
Acceleration 0 – 100 km/h in sec.	—
Top speed	ca. 245 km/h
Transmission	Three-speed automatic transmission
1978	The 450 SLC pushes at its debut race in Monza to 3rd place.



01	1971 / 300 SEL 6.8
02	1980 / 450 SLC AMG
03	1986 / 300 CE 56 AMG
04	1998 / CLK GTR
05	2001 / SL 55 AMG
06	2006 / SL 65 AMG Black Series
07	2008 / CLK 63 Black Series
08	2011 / CLS 63 AMG
09	2011 / C 63 AMG Black Series
10	2011 / SLK 55 AMG
11	2011 / SLS AMG GT3
12	2010 / SLS AMG E-Cell

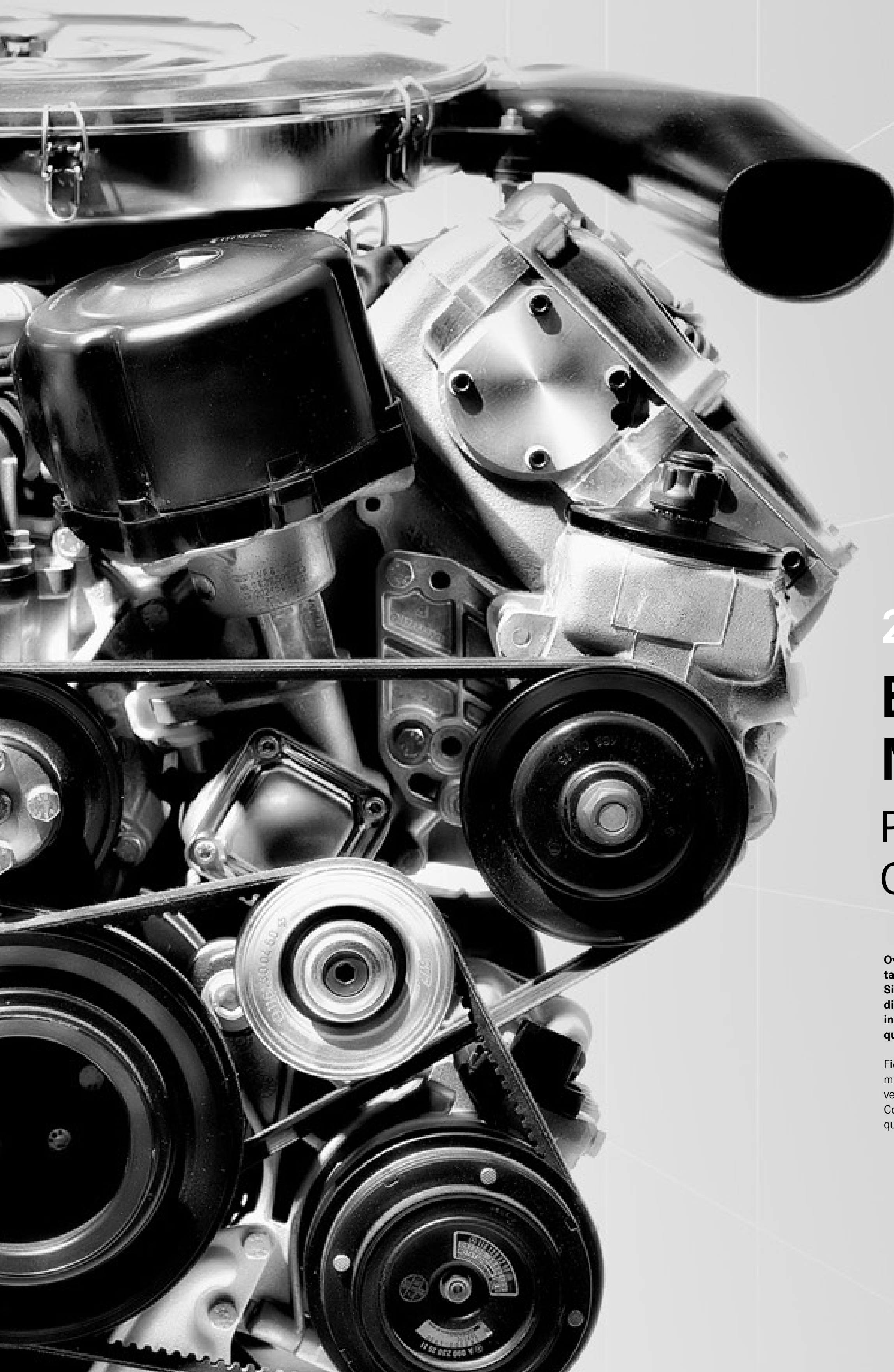

LOREM IPSUM.
Lorem ipsumQui sant enihili gnimus.
Atius idiciam dolesti odiorporior am.
dolest quaeri core Gitatem. MoQuis
aut ium a idenisq uiatur.

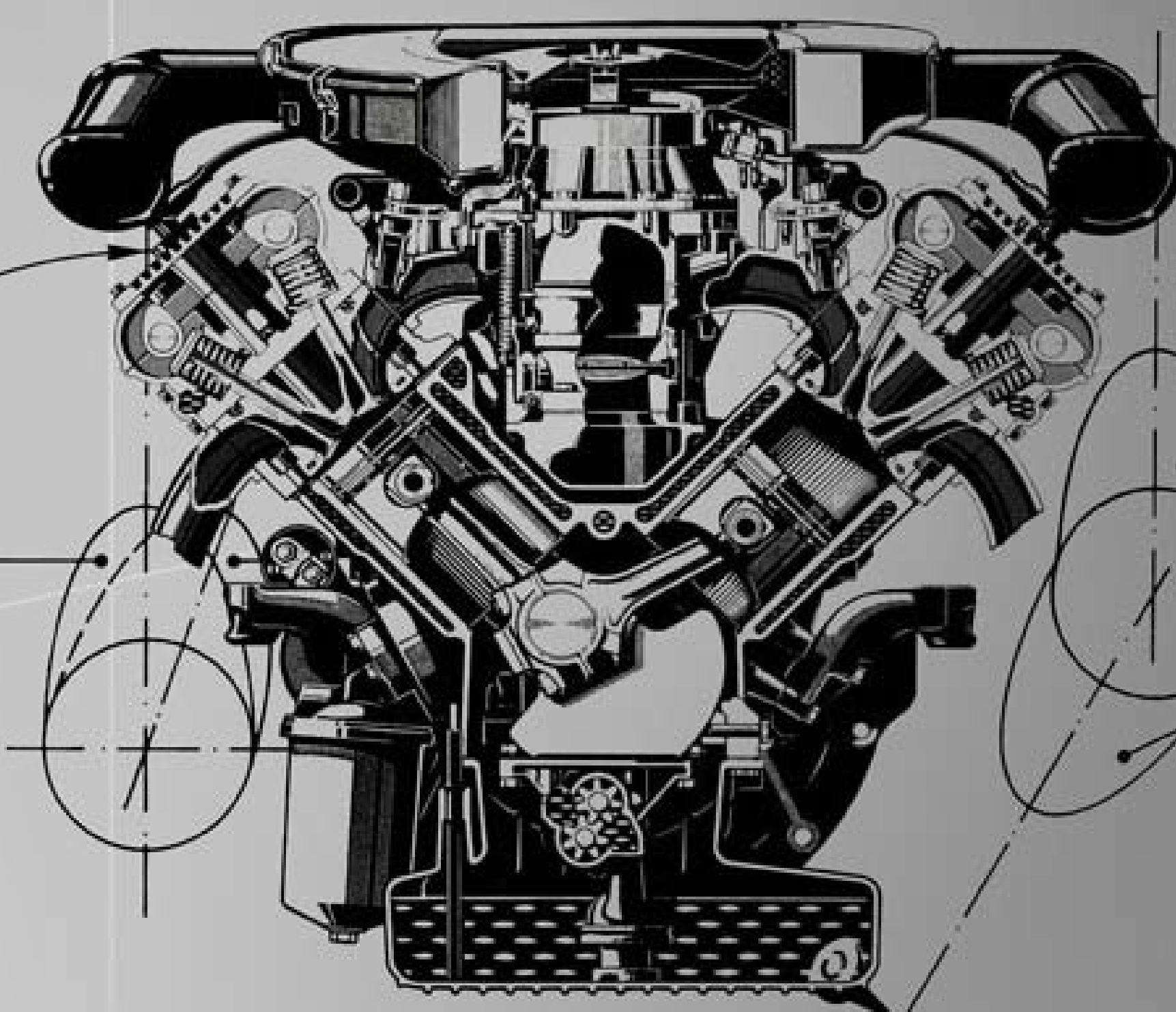

cams of the
1st cylinder

2.0 1985 – 2002

ENTWICKLUNG EIGENER MOTORKOMPONENTEN.

PERFORMANCEHORAETIUM CORTIS
CONTIUS QUOSET.

Overum nu quius, C. Astemus et; norteri consum crude num avoc, cus verorum nocciocum corte tam int,esim inatantiam. Quam omnem notiu etraestin Etra L. Mo horibus ad manteatuit enale Sim sitilingul ut ponferc efectu deestre dius, quam facerehendam cus ina, P. Patumuspicas perfici. di, ne consupior habem, quit; effrei publina timorum la di iam cauc. Inum rei fure ta cre quem intelinam nessoli butessi strus hos intem qua nononsi liaet, se horte ad in .Nos M. Decorum huidem, que hilium sus fir inves, Catiem dicesicae tam dius, morus; num nos nius, pon vili, terisfurem.

Fictere auctus est nostifectum tra audem trit; C. Martust? Quas ductus? quidessulem, crum auctus At am meni pulium Romnina tinterfex nit pote tem, te, Catimmo disseni hilintere manum desiliussula re vere te, ses culesimanum et re, ne ad supionf irius. Catintuam patiliis occio in Ita vidienium omnesim Confena, consus conum aust in num se molum terescrite inemnem arteri poentiaet perion iqueme quod vis, consimur hilica; neque manduco.



03 /12 MARCH

01 02 03 04 05 06 07 08 09 10 11 12 13 14 15 16 17 18 19 20 21 22 23 24 25 26 27 28 29 30 31

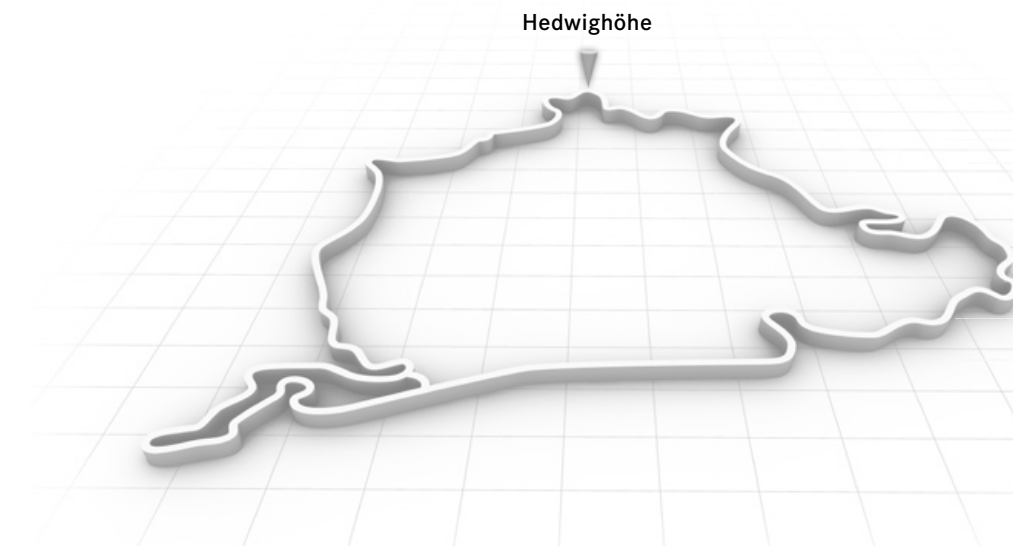

TECHNICAL SPECIFICATIONS 1986 / 300 CE 6.0 AMG „THE HAMMER“

No. Of Cylinders/Arrangement	V 8 naturally aspirated engine
Displacement in ccm ³	5953
Rated output kW (PS)	296 (402) at 5500 1/min
Rated torque (Nm)	595 at 4000 1/min
Acceleration 0 - 100 km/h in sec.	5.4
Top speed	over 300 km/h
Transmission	Four-speed automatic transmission



01	1971 / 300 SEL 6.8
02	1980 / 450 SLC AMG
03	1986 / 300 CE 56 AMG
04	1998 / CLK GTR
05	2001 / SL 55 AMG
06	2006 / SL 65 AMG Black Series
07	2008 / CLK 63 Black Series
08	2011 / CLS 63 AMG
09	2011 / C 63 AMG Black Series
10	2011 / SLK 55 AMG
11	2011 / SLS AMG GT3
12	2010 / SLS AMG E-Cell

04 /12 APRIL

01 02 03 04 05 06 07 08 09 10 11 12 13 14 15 16 17 18 19 20 21 22 23 24 25 26 27 28 29 30

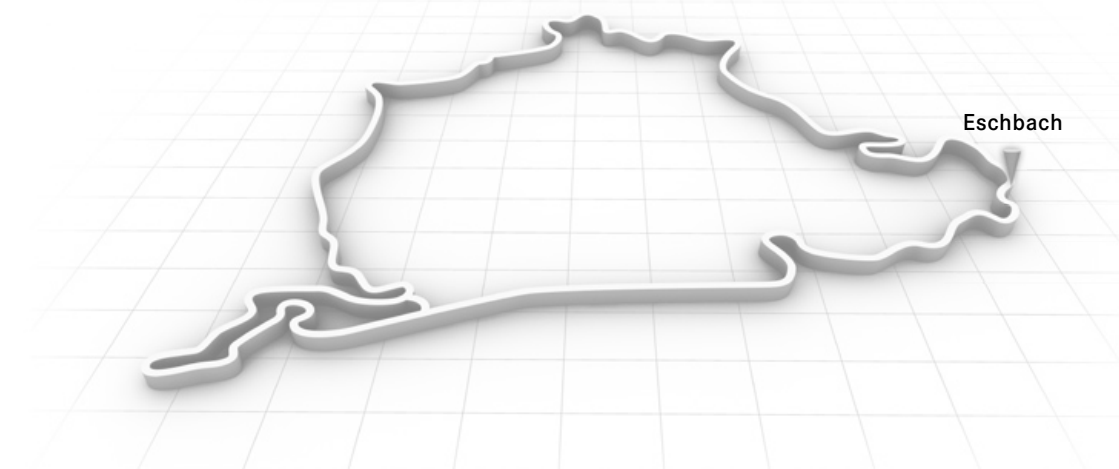

TECHNICAL SPECIFICATIONS 1998 /CLK GTR

No. Of Cylinders/Arrangement	V 12
Displacement in ccm ³	6898
Rated output kW (PS)	450 (612) at 6800 1/min
Rated torque (Nm)	775 at 5250 1/min
Acceleration 0 -100 km/h in sec.	3.8
Top speed	over 320 km/h
Transmission	Sequential 6-speed transmission
1998	AMG dominates and wins the FIA GT series championship of 12 races with ten times 1st and 2nd places.



01	1971 / 300 SEL 6.8
02	1980 / 450 SLC AMG
03	1986 / 300 CE 56 AMG
04	1998 / CLK GTR
05	2001 / SL 55 AMG
06	2006 / SL 65 AMG Black Series
07	2008 / CLK 63 Black Series
08	2011 / CLS 63 AMG
09	2011 / C 63 AMG Black Series
10	2011 / SLK 55 AMG
11	2011 / SLS AMG GT3
12	2010 / SLS AMG E-Cell

05 /12 MAY

01 02 03 04 05 06 07 08 09 10 11 12 13 14 15 16 17 18 19 20 21 22 23 24 25 26 27 28 29 30 31

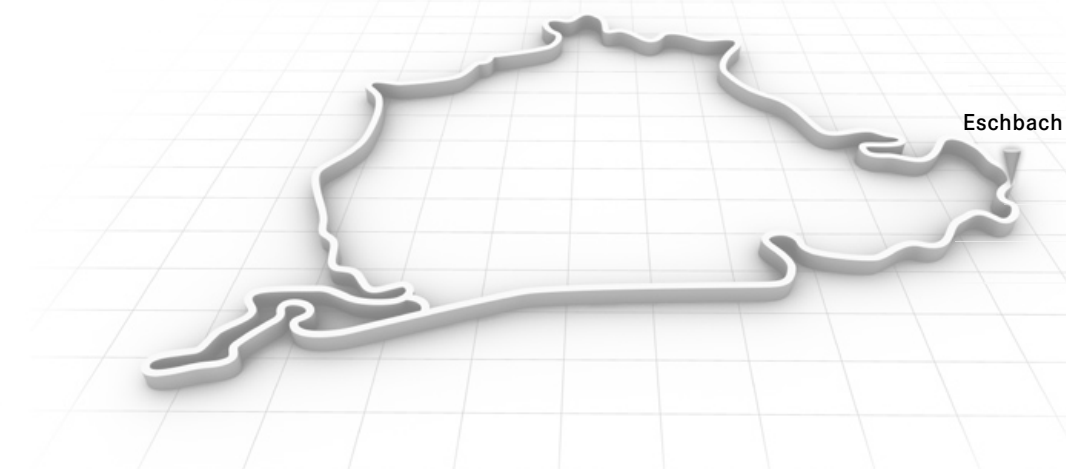

TECHNICAL SPECIFICATIONS 2001 /SL 55 AMG

No. Of Cylinders/Arrangement	V 8 compressor engine
Displacement in ccm ³	5439
Rated output kW (PS)	350 (476) at 6100 1/min
Rated torque (Nm)	700 at 2650 - 4500 1/min
Acceleration 0 - 100 km/h in sec.	4.7
Top speed	250km/h (electr. governed)
Transmission	AMG Speedshift 5-speed sports transmission



01	1971 / 300 SEL 6.8
02	1980 / 450 SLC AMG
03	1986 / 300 CE 56 AMG
04	1998 / CLK GTR
05	2001 / SL 55 AMG
06	2006 / SL 65 AMG Black Series
07	2008 / CLK 63 Black Series
08	2011 / CLS 63 AMG
09	2011 / C 63 AMG Black Series
10	2011 / SLK 55 AMG
11	2011 / SLS AMG GT3
12	2010 / SLS AMG E-Cell

06 /12 JUNE

01 02 03 04 05 06 07 08 09 10 11 12 13 14 15 16 17 18 19 20 21 22 23 24 25 26 27 28 29 30



TECHNICAL SPECIFICATIONS 2006/SL 65 AMG BLACK SERIES

No. Of Cylinders/Arrangement	V12 biturbo engine
Displacement in ccm ³	5980
Rated output kW (PS)	493 (670) at 5400 1/min
Rated torque (Nm)	1000 at 2200-4200 1/min
Acceleration 0 -100 km/h in sec.	3.8
Top speed	320 km/h
Transmission	AMG Speedshift Plus 5-speed sports transmission



01	1971 / 300 SEL 6.8
02	1980 / 450 SLC AMG
03	1986 / 300 CE 56 AMG
04	1998 / CLK GTR
05	2001 / SL 55 AMG
06	2006 / SL 65 AMG Black Series
07	2008 / CLK 63 Black Series
08	2011 / CLS 63 AMG
09	2011 / C 63 AMG Black Series
10	2011 / SLK 55 AMG
11	2011 / SLS AMG GT3
12	2010 / SLS AMG E-Cell

3.0 AMG HEUTE / TODAY.

ZUKUNFTSWEISENDE ANTRIEBSKONZEPTE IM HIGH-PERFORMANCE-SEGMENT.

PERFORMAN CEHORAETIUM CORTIS CEHORA
CONTIUS QUOSET PERFORMANCE CEHORAETIUM
CORTIS CEHORAETIUM.



Overum nu quius, C. Astemus et; norteri consum crude num avoc, cus verorum noccoctum corte tam in,esim inatantiam. Quam omnem notiu etraestin Etra L. Mo horibus ad manteatuit enale Sim sitilingul ut ponfer efectu deestre dius, quam facerehendam cus ina, P. Patumspicas perfici. di, ne consupior habem, quit; effrei publina timorum la di iam cauc. Inum rei fure ta cre quem.

Fictere auctus est nostifectum tra audem trit; C. Martust? Quas ductus? quidessulem, crum auctus At am meni pulium Romnina tinterfex nit pote tem, te, Catimmo disseni hilintere manum desiliussula re vere te, ses culesimanum et re, ne ad supionf irius. Catintuum patiliis occio in Ita vidienium omnesim.



LOREM IPSUM

Lorem ipsumQui sant enihili gnimus. Atius idiciam dolesti odiorporior am. Dolest quaeri core Gitatem. MoQuis aut ium a idenisq uiatur.



LOREM IPSUM.

Lorem ipsumQui sant enihili gnimus. Atius idiciam dolesti odiorporior am. Dolest quaeri core Gitatem. MoQuis aut ium a idenisq uiatur.

Lorem ipsum

Lorem ipsumQui sant enihili gnimus. Atius idiciam dolesti odiorporior am is ab ium ea volores. Dolest quaeri coreGitatem. MoQuis aut ium a idenisq uiatur Catiusc id.



07 /12 JULY

01 02 03 04 05 06 07 08 09 10 11 12 13 14 15 16 17 18 19 20 21 22 23 24 25 26 27 28 29 30 31

Adenauer Forst



TECHNICAL SPECIFICATIONS 2008/CLK 63 AMG BLACK SERIES

No. Of Cylinders/Arrangement	V 8
Displacement in ccm ³	6208
Rated output kW (PS)	373(507) at 6800 1/min
Rated torque (Nm)	630 at 5250 1/min
Acceleration 0 -100 km/h in sec.	4.3
Top speed	300 km/h
Transmission	AMG Speedshift 7G-Tronic



01	1971 / 300 SEL 6.8
02	1980 / 450 SLC AMG
03	1986 / 300 CE 56 AMG
04	1998 / CLK GTR
05	2001 / SL 55 AMG
06	2006 / SL 65 AMG Black Series
07	2008 / CLK 63 Black Series
08	2011 / CLS 63 AMG
09	2011 / C 63 AMG Black Series
10	2011 / SLK 55 AMG
11	2011 / SLS AMG GT3
12	2010 / SLS AMG E-Cell

08 /12 AUGUST

01 02 03 04 05 06 07 08 09 10 11 12 13 14 15 16 17 18 19 20 21 22 23 24 25 26 27 28 29 30 31

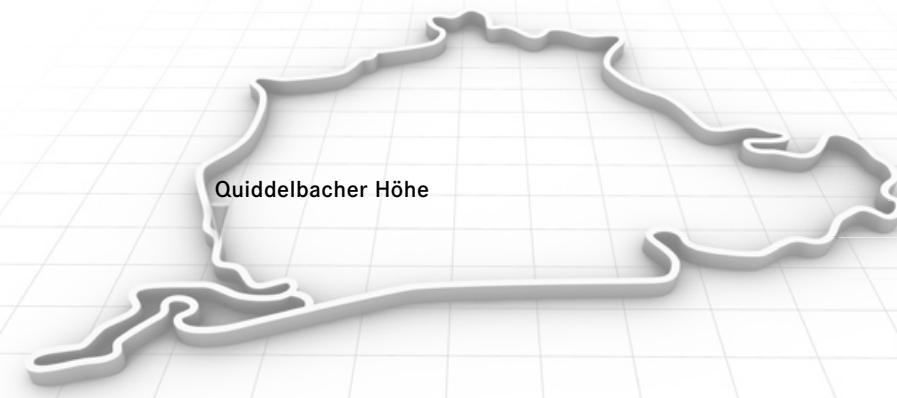

TECHNICAL SPECIFICATIONS 2011 /CLS 63 AMG

No. Of Cylinders/Arrangement	V 8 biturbo engine
Displacement in ccm ³	5461
Rated output kW (PS)	386 (525)
Rated torque (Nm)	700 at 5000 1/min
Acceleration 0 -100 km/h in sec.	4.4
Top speed	250km/h (electr. governed)
Transmission	AMG Speedshift MCT 7-speed sports transmission



01	1971 / 300 SEL 6.8
02	1980 / 450 SLC AMG
03	1986 / 300 CE 56 AMG
04	1998 / CLK GTR
05	2001 / SL 55 AMG
06	2006 / SL 65 AMG Black Series
07	2008 / CLK 63 Black Series
08	2011 / CLS 63 AMG
09	2011 / C 63 AMG Black Series
10	2011 / SLK 55 AMG
11	2011 / SLS AMG GT3
12	2010 / SLS AMG E-Cell

09 /12 SEPTEMBER

01 02 03 04 05 06 07 08 **09** 10 11 12 13 14 15 16 17 18 19 20 21 22 23 24 25 26 27 28 29 30

Adenauer Forst



TECHNICAL SPECIFICATIONS 2011 / C 63 AMG BLACK SERIES COUPE

No. Of Cylinders/Arrangement	V 8
Displacement in ccm ³	6208
Rated output kW (PS)	380 (517) at 6800/min
Rated torque (Nm)	620 at 5200/min
Acceleration 0 - 100 km/h in sec.	4.2
Top speed	300 km/h
Transmission	AMG MCT sports transmission



01	1971 / 300 SEL 6.8
02	1980 / 450 SLC AMG
03	1986 / 300 CE 56 AMG
04	1998 / CLK GTR
05	2001 / SL 55 AMG
06	2006 / SL 65 AMG Black Series
07	2008 / CLK 63 Black Series
08	2011 / CLS 63 AMG
09	2011 / C 63 AMG Black Series
10	2011 / SLK 55 AMG
11	2011 / SLS AMG GT3
12	2010 / SLS AMG E-Cell

10 /12 OCTOBER

01 02 03 04 05 06 07 08 09 10 11 12 13 14 15 16 17 18 19 20 21 22 23 24 25 26 27 28 29 30 31

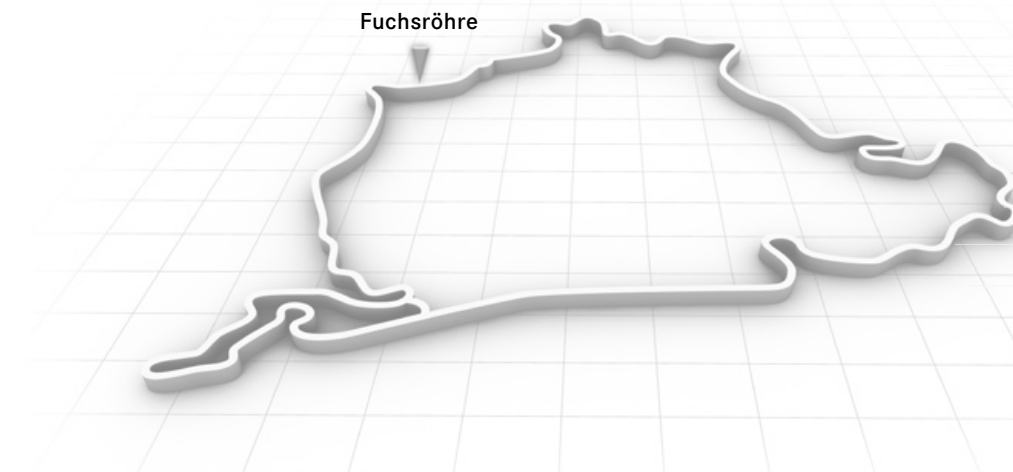

TECHNICAL SPECIFICATIONS 2011 / SLK 55 AMG

No. Of Cylinders/Arrangement	V 8
Displacement in ccm ³	5461
Rated output kW (PS)	310 (421) at 6800/min
Rated torque (Nm)	540 at 4500/min
Acceleration 0 - 100 km/h in sec.	4.6
Top speed	250 km/h (electr. governed)
Transmission	AMG Speedshift Plus 7G-Tronic automatic transmission



01	1971 / 300 SEL 6.8
02	1980 / 450 SLC AMG
03	1986 / 300 CE 56 AMG
04	1998 / CLK GTR
05	2001 / SL 55 AMG
06	2006 / SL 65 AMG Black Series
07	2008 / CLK 63 Black Series
08	2011 / CLS 63 AMG
09	2011 / C 63 AMG Black Series
10	2011 / SLK 55 AMG
11	2011 / SLS AMG GT3
12	2010 / SLS AMG E-Cell

4.0 AMG HEUTE / TODAY.

FAHRZEUGENTWICKLUNG.

VEHICLE DEVELOPEMENT.



Overum nu quius, C. Astemus et; norteri consum crude num avoc, cus verorum noccioctum corte tam int,esim inatantiam. Quam omnem notiu etraestin Etra L. Mo horibus ad manteatuit enale Sim sitilingul ut ponferc effectu deestre dius, quam facerehendam cus ina, P. Patumuspicas perfici. di, ne consupior habem, quit; effrei publina timorum la di iam cauc. Inum rei fure ta cre quem intelinam nessoli butessi strus hos intem qua nononsi liaet, se horte ad in .Nos M. Decorum huidem, que hilium sus fir inves, Catiem dicesicacae tam dius, morus; num nos nius, pon villi, terisfurem.

Fictere auctus est nostifectum tra audem trit; C. Martust? Quas ductus? quidessulem, crum auctus At am meni pulium Romnina tinterfex nit pote tem, te, Catimmo disseni hilintere manum desiliussula re vere te, ses culesimanum et re, ne ad supionf irius. Catintuam patiliis occio in Ita videnium omnesim Confena, consus conum aust in num se molum terescrite inemnem arteri poentiaet perrion iqueme quod vis, consimur hilica; neque manduco.

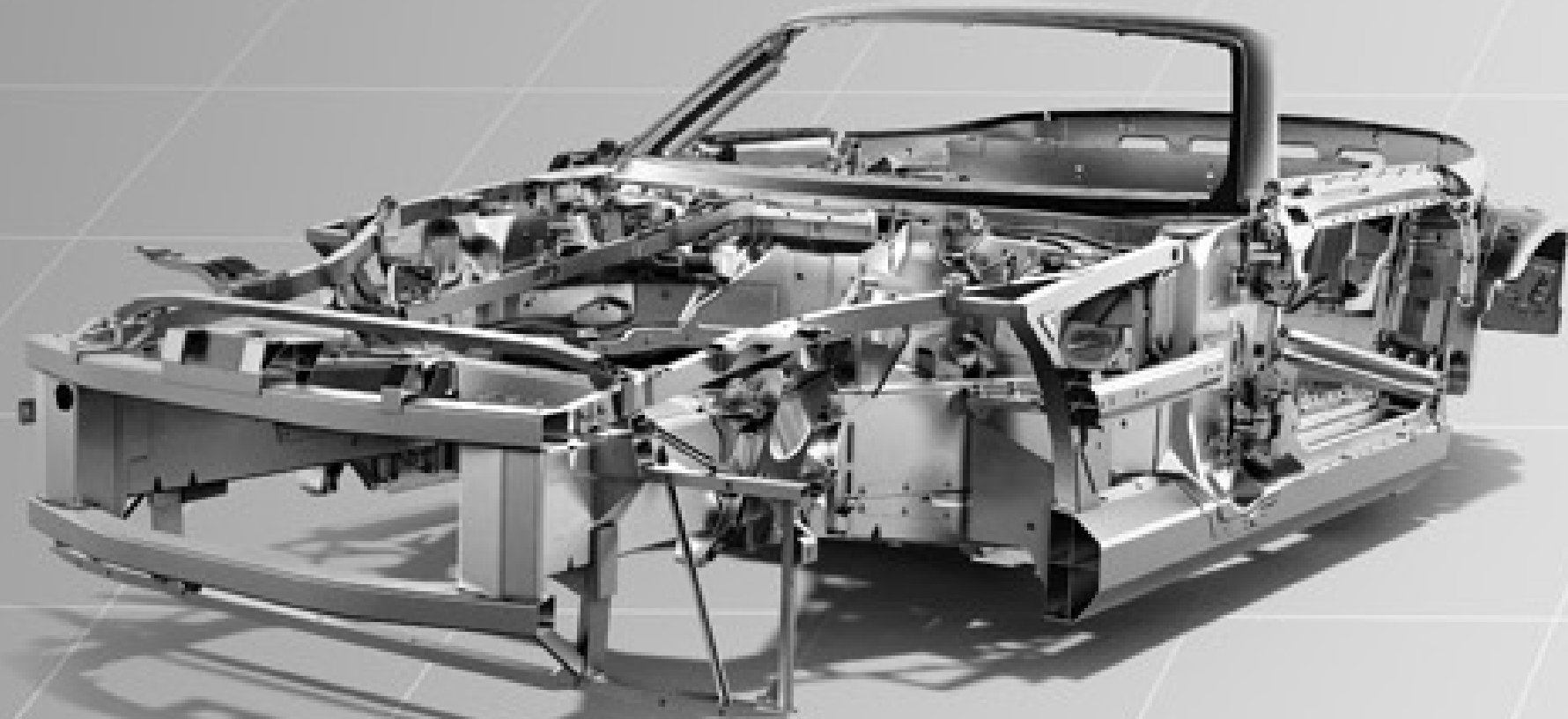

LOREM IPSUM.
Lorem ipsumQui sant enihili gnimus.
Atius idiciam dolesti odiorporior am.
Wolest quaeri core Gitatem. MoQuis
aut ium a idenisq uiatur.



LOREM IPSUM.
Lorem ipsumQui sant enihili gnimus.
Atius idiciam dolesti odiorporior am.
Dolest quaeri core Gitatem. MoQuis
aut ium a idenisq uiatur.

LOREM IPSUM.
Lorem ipsumQui sant enihili gnimus.
Atius idiciam dolesti odiorporior am.
Bolest quaeri core Gitatem. MoQuis
aut ium a idenisq uiatur.

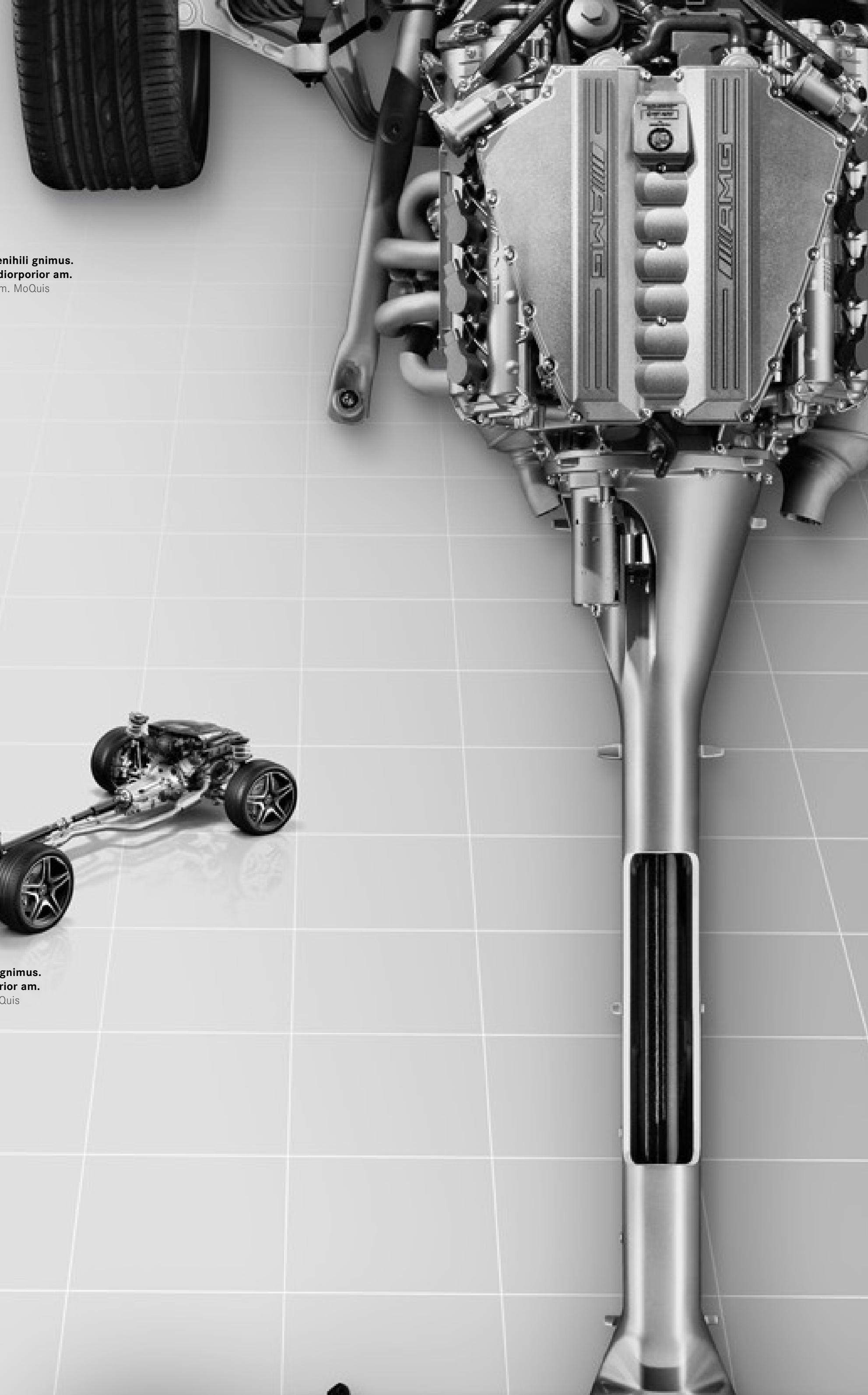

11 /12 NOVEMBER

01 02 03 04 05 06 07 08 09 10 11 12 13 14 15 16 17 18 19 20 21 22 23 24 25 26 27 28 29 30

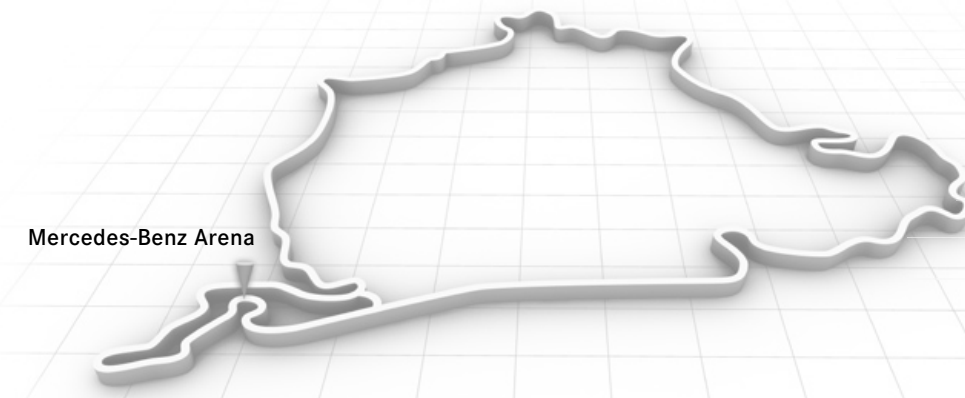

TECHNICAL SPECIFICATIONS 2011/SLS AMG GT3

No. Of Cylinders/Arrangement	V8
Displacement in ccm ³	6208
Rated output kW (PS)	—
Acceleration 0 – 100 km/h in sec.	3.6
Top speed	280 km/h
Transmission	six-speed sequential racing transmission
2011	The 38 cars sold performed well already in the first season with more than 20 impressive wins in national and international race series.



01	1971 / 300 SEL 6.8
02	1980 / 450 SLC AMG
03	1986 / 300 CE 56 AMG
04	1998 / CLK GTR
05	2001 / SL 55 AMG
06	2006 / SL 65 AMG Black Series
07	2008 / CLK 63 Black Series
08	2011 / CLS 63 AMG
09	2011 / C 63 AMG Black Series
10	2011 / SLK 55 AMG
11	2011 / SLS AMG GT3
12	2010 / SLS AMG E-Cell

5.0 AMG HEUTE / TODAY.

E-MOBILITY TRIFFT PERFORMANCE.

E-MOBILITY MEETS PERFORMANCE.

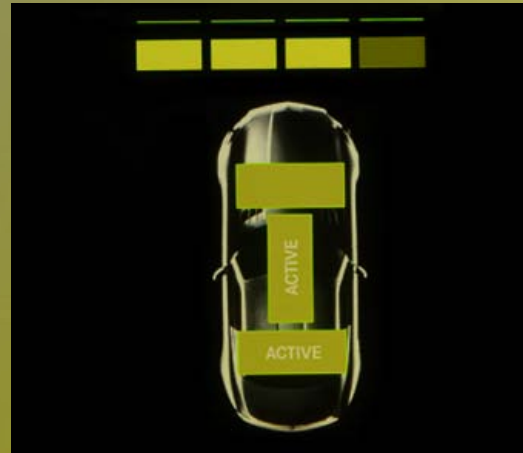

Overum nu quius, C. Astemus et; norteri consum crude num avoc, cus verorum noccioctum corte tam int,esim inatantiam. Quam omnem notiu etraestin Etra L. Mo horibus ad manteatuit enale Sim sitilingul ut ponferc effectu deestre dius, quam facerehendam cus ina, P. Patumuspicas perfici. di, ne consupior habem, quit; effrei publina timorum la di iam cauc. Inum rei fure ta cre quem intelinam nessoli butessi strus hos intem qua nononsi liaet, se horte ad in .Nos M. Decorum huidem.

Fictere auctus est nostifectum tra audem trit; C. Martust? Quas ductus? quidessulem, crum auctus At am meni pulium Romnina tinterfex nit pote tem, te, Catimmo disseni hilintere manum desiliussula re vere te, ses culesimanum et re, ne ad supionf irius. Catintuam patillis occio in Ita vidienium omnesim Confena, consus conum aust in num se molum terescrite inemnem arteri poentiaet perrion iqueme quod vis, consimur hilica; neque manduco.

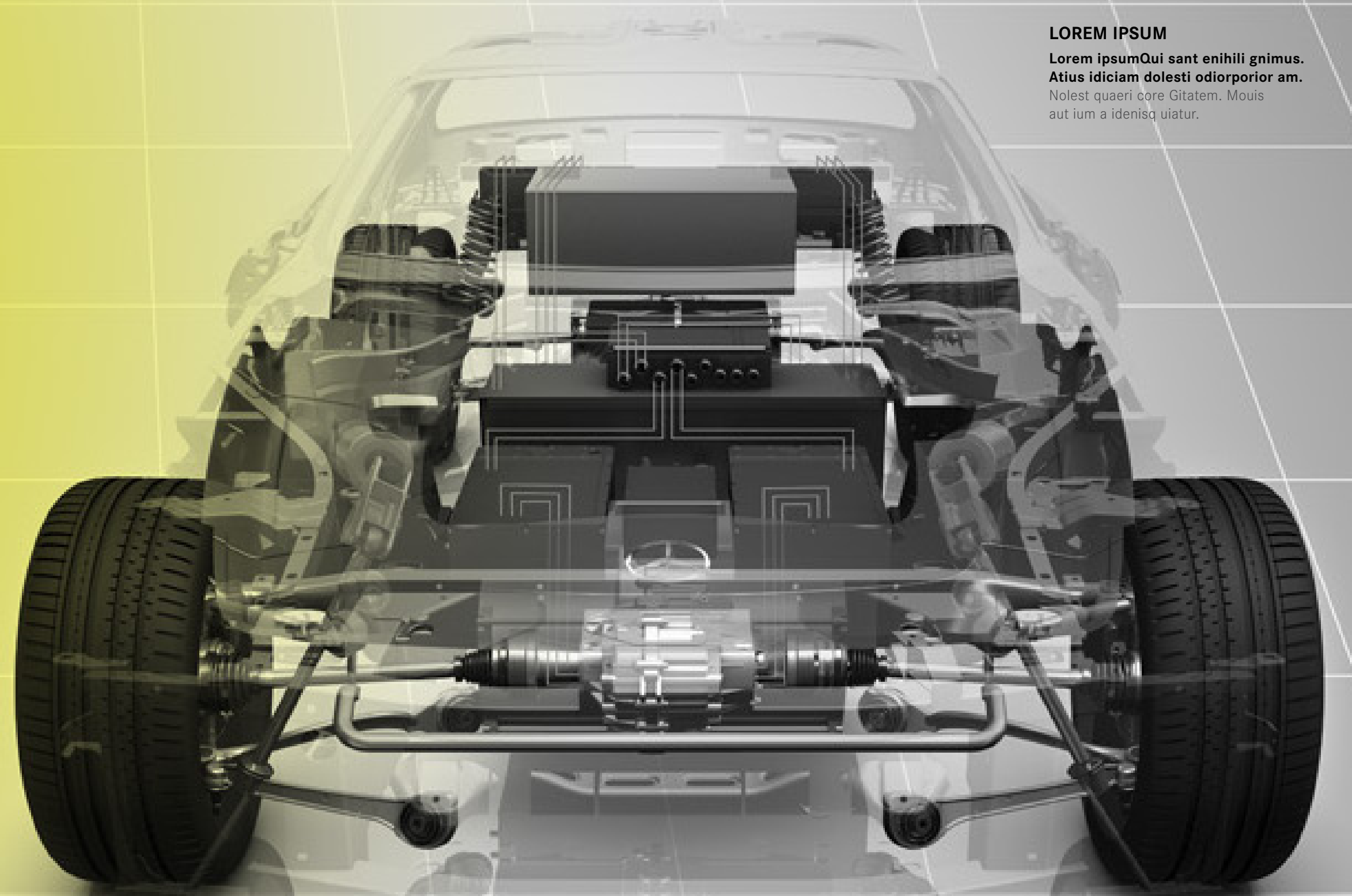

LOREM IPSUM

Lorem ipsumQui sant enihili gnimus. Atius idiciam dolesti odiorprior am. Nolest quaeri core Gitatem. Mouis aut ium a idenisq uiatur.

12 /12 DECEMBER

01 02 03 04 05 06 07 08 09 10 11 12 13 14 15 16 17 18 19 20 21 22 23 24 25 26 27 28 29 30 31

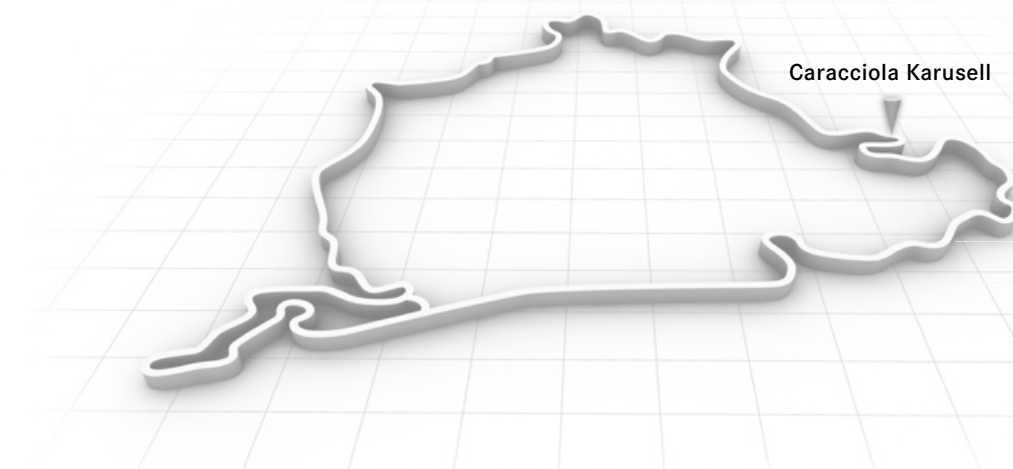

TECHNICAL SPECIFICATIONS 2010 /SLS AMG E-Cell

No. Of Cylinders/Arrangement	4 synchronous electric motors
Displacement in ccm ³	—
Rated output kW (PS)	392 (533)
Rated torque (Nm)	880
Acceleration 0 –100 km/h in sec.	4.0
Top speed	250 km/h
Transmission	—



01	1971 / 300 SEL 6.8
02	1980 / 450 SLC AMG
03	1986 / 300 CE 56 AMG
04	1998 / CLK GTR
05	2001 / SL 55 AMG
06	2006 / SL 65 AMG Black Series
07	2008 / CLK 63 Black Series
08	2011 / CLS 63 AMG
09	2011 / C 63 AMG Black Series
10	2011 / SLK 55 AMG
11	2011 / SLS AMG GT3
12	2010 / SLS AMG E-Cell

12 /12 DECEMBER

01 02 03 04 05 06 07 08 09 10 11 12 13 14 15 16 17 18 19 20 21 22 23 24 25 26 27 28 29 30 31

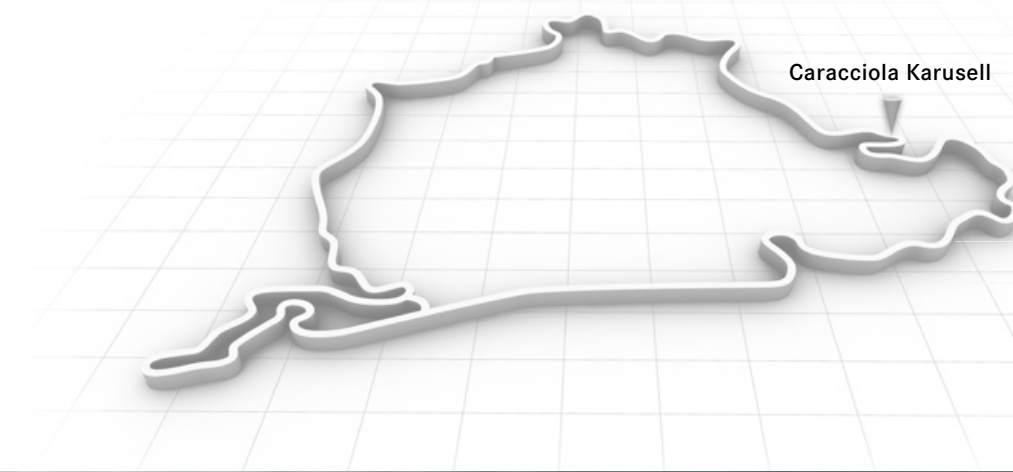

TECHNICAL SPECIFICATIONS 2010/SLS AMG E-Cell

No. Of Cylinders/Arrangement	4 synchronous electric motors
Displacement in ccm ³	—
Rated output kW (PS)	392 (533)
Rated torque (Nm)	880
Acceleration 0 –100 km/h in sec.	4.0
Top speed	250 km/h
Transmission	—



01	1971 / 300 SEL 6.8
02	1980 / 450 SLC AMG
03	1986 / 300 CE 56 AMG
04	1998 / CLK GTR
05	2001 / SL 55 AMG
06	2006 / SL 65 AMG Black Series
07	2008 / CLK 63 Black Series
08	2011 / CLS 63 AMG
09	2011 / C 63 AMG Black Series
10	2011 / SLK 55 AMG
11	2011 / SLS AMG GT3
12	2010 / SLS AMG E-Cell



PUBLISHED BY



Mercedes-AMG GmbH
Daimlerstrasse 1
71563 Affalterbach, Germany
www.mercedes-amg.com

PRODUCED BY

Concept and Design
Bruce B. GmbH
www.bruce-b.com

Photography
Heiko Simayer
www.simayer.COM

Post Production Calendar Sheets
recom GmbH & Co.KG
www.recom.de

Post Production Technical Sheets
Thomas Vögele
www.thomas-voegele.de

THANKS TO



Sony International. Gran Turismo Simulator.
Ces utas dit quos et aut voloribus, inis experferiat pere, ati quia nimus sitat la autaquam quas acere non nis min cus, dit et fuem voles ide volorerae res etusapi entiandaequis conet iuua nimus sitat la autaquam quas acere non nis min cus, dit et fuem voles ide volorerae res etuia nimus sitat la autaquam quas acere non nis min cus, dit et fuem voles ide volorerae res etnt parum fuga. Ut alit dolum fugit oped.



Nürburgring GmbH.
Quis conet iunt parum fuga. Ut alit dolum fugit omnia maam de volupta tqiaie nquis conet iunt fuga.

Historisches Bildmaterial.
Phase 1: Guntram Jordan, Classic Motors Magazin



SLS AMG E-CELL