



CLS-Class

Mercedes-Benz

From the Mercedes-Benz dream factory

Contents

The CLS	4	My CLS	50
Exterior design	4	Equipment	52
Agility	16	Standard equipment	52
BlueEFFICIENCY	16	Optional extras	54
Diesel engines	18	Light-alloy wheels	58
Petrol engines	20	Genuine accessories	60
Transmissions	24	Colours and materials	62
AIRMATIC	26	Paint finishes	62
Safety	28	Upholstery and leather	64
AMG	32	Trim parts	66
CLS 63 AMG	32	designo	67
AMG Performance Studio	35	Combination options	70
AMG equipment	37	Technical data	71
Interior comfort	38	Services	74
Interior – designo	46		

Words cannot do it justice: the sign of a true masterpiece

There are moments in life which take our breath away. Moments in which we lose ourselves in contemplation of a masterpiece and forget the world around us. The CLS, an inimitable combination of a sporty coupé and a luxurious saloon which is always the focus of admiring looks, is difficult to define in words. It simply has to be experienced.









CLS500



S OU 4664



There's more to true beauty than just the sum of its individual parts



Some designer pieces are better off on the road than in a museum

The expressive lines of the CLS stylishly reconcile the sporty feel of a coupé with the elegance of a classic 4-door saloon. The characteristic side feature line, the dynamic curve of the arching roof and the unmistakable profile lend the CLS a timeless beauty. Its entire appearance is a statement of automotive self-confidence. Quite simply, it is an accomplished combination of agility and comfort. Judicious adjustments to some of its exterior details, meanwhile, now make the design of the CLS more attractive than ever.









Good design begins in
the head of the designer
and ends in the heart of
the observer

Those familiar with the CLS will notice that its face is now more expressive. The area between the familiar, L-shaped headlamps is spanned by two louvres, backed by an atlas grey diamond-pattern grille. This design element, which is also to be found in the air intakes in the front bumper, adds discreet emphasis to the incisive look of the front section. The arrow-shaped indicator lamps in the exterior mirrors are another eye-catching feature.





The characteristic spoiler lip at the rear provides a fitting conclusion to the distinctive design idiom of the CLS. The stylish lines of the boot lid conceal a luggage compartment which introduces a large measure of everyday practicality to the equation. Trapezoidal exhaust tailpipes and elegantly designed tail lights add the finishing touch to the attractive rear section.

BlueEFFICIENCY – innovations for efficient mobility

We do not pay lip service to protection of the environment. It's a matter close to our hearts. As the inventor of the motor car, Mercedes-Benz has a special responsibility – one we have undertaken with all our might for many years. We can already offer you 66 models that place far less of a burden on the environment – without having to compromise on safety, comfort and driving enjoyment.

Our BlueEFFICIENCY concept comprises innovations for efficient mobility as well as optimised processes all the way along the value chain. They involve different approaches, but they all have a common goal: to make your individual mobility as sustainable as possible.

The BlueEFFICIENCY measures – the Mercedes-Benz efficiency package. The BlueEFFICIENCY measures are comprehensive vehicle optimisations which save fuel and, therefore, ease the burden on the environment. Each model combines the most efficient engine with optimal aerody-

amic and energy-management measures to minimise fuel consumption. Such measures include intelligently controlled ancillaries, tyres with optimised rolling resistance, the ECO start/stop function, lightweight components and an aerodynamically optimised body design. All in all, these measures allow substantial savings to be made: fuel consumption and, therefore, CO₂ emissions are reduced by up to 23 %.



The BlueEFFICIENCY measures bring about a substantial reduction in fuel consumption and CO₂ emissions

BlueTEC – the clean diesel. Mercedes-Benz has brought to market BlueTEC technology for diesel engines based on common-rail direct injection (CDI). It combines optimised combustion with a modular emission-control system, all of which makes BlueTEC an exceptionally clean diesel technology. Not only does it remove up to 95 % of the particulate from the exhaust gases, it also reduces nitrogen oxides by up to 90 %. All that remains is water, harmless nitrogen and the satisfying feeling of having helped to ease the burden on the environment.



BlueTEC filters out up to 95 % of the particulate and converts up to 90 % of the nitrogen oxides into harmless nitrogen

HYBRID – the intelligent combination of petrol and electric drive. A well-established team makes a lot of things easier. And this is certainly true in the case of HYBRID technology. During braking, the electric motor supplies the battery with kinetic energy. When needed, this energy is forwarded to the electric drive, which assists the petrol engine when the car is accelerating. What's more, the ECU shuts off the petrol engine when the speed falls below 15 km/h. In this way, a HYBRID can reduce fuel consumption by up to 20 %. So it looks after the environment as well as your bank balance. Perfect teamwork, you might say.



HYBRID technology reduces fuel consumption by up to 20%

BlueTEC HYBRID – clean diesel combined with electric drive. BlueTEC HYBRID technology marries the benefits of HYBRID technology with those of BlueTEC technology: during braking, the kinetic energy is converted into electrical energy, which can be re-used when required. At the same time, the BlueTEC technology cleans the exhaust gases and removes most of the pollutants.

Innovative drive systems that break new ground. Concept BlueZERO F-CELL, E-CELL and E-CELL PLUS. Mercedes-Benz has developed three further



BlueTEC HYBRID combines clean diesel technology with electric drive, and will be available from 2012

drive concepts with an electric motor and a battery for storing energy as part of its close-to-production Concept BlueZERO: E-CELL with an electric motor, which only draws its energy from the battery; E-CELL PLUS with a battery and an internal combustion engine (Range Extender); and F-CELL with an additional fuel cell for generating power.

But that is not all: under the banner “Design for Environment”, we also look at a vehicle's entire lifecycle – from planning to recycling. The same applies to the building and running of new factories. In addition, Mercedes-Benz is involved in the development of alternative fuels and carries out research in the field of bionics. In short, BlueEFFICIENCY is good news for both you and the environment.

Further information about our comprehensive measures can be found at:

www.mercedes-benz.com/blueefficiency



When you invest in a work of art, you should be *au fait* with the techniques used

There's more to life than just looking good. That's why the impressive CLS engines also deliver outstanding performance. If you want immense pulling power, superb refinement and excellent fuel economy, the CLS 350 CDI with its V6 diesel engine is just the thing. The powerplant develops 165 kW and a peak torque of 540 Nm from 1600 rpm. All of which makes for delightful responsiveness when accelerating and impressive pulling power when you suddenly want a quick burst of speed.

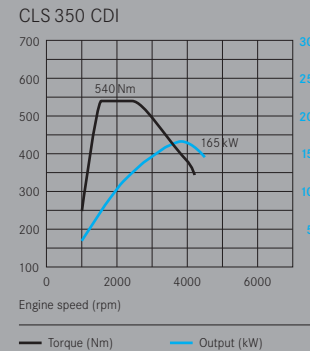

Equipped with the very latest common-rail diesel technology, the V6 engine delivers high torque even at low revs

Looks its best when on the move

It's entirely up to you just how spirited you want your CLS to be. The petrol range offers a choice of two V6 engines and a V8 powerplant. The entry-level model is the CLS 300, which has an output of 170 kW and impresses with its highly responsive character. Those looking for a combination of sporty flair and innovative engine technology will find the CLS 350 CGI ideal. In this unit, the fuel is injected directly into the combustion chamber under high pressure via special piezo-electric injectors. This results in almost complete combustion of the fuel, thereby reducing exhaust emissions too. Although capable of developing an impressive 215 kW, the dynamic CLS 350 CGI also returns favourable fuel consumption figures.

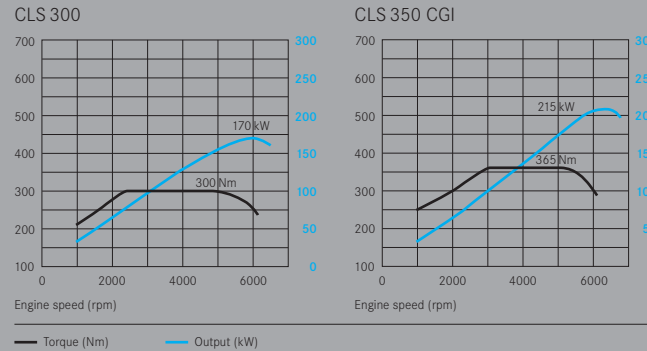

Which of the V6 petrol engines you choose is entirely a matter of personal taste – both offer an impressively comfortable driving experience







Tastes will always differ. Expectations too

The CLS 500 takes the concept of effortless superiority to even greater heights thanks to its 285-kW V8 engine which makes sporty driving a sheer pleasure. With a displacement of 5461 cc, this unit makes its rated torque of 530 newton metres available across a pleasingly broad engine speed range (2800 to 4800 rpm) to deliver thrilling pulling power. But regardless of the engine version you choose, you can always count on the CLS to deliver an extremely agile yet comfortable drive.

CLS 500

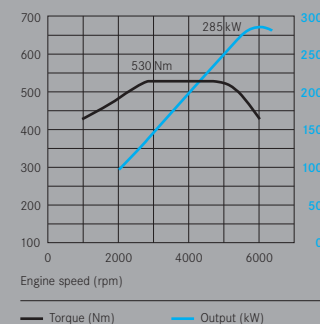

The V8 petrol engine in the CLS 500 impresses with its smoothness and its dynamic power delivery – assets which combine to create an effortlessly superior driving experience

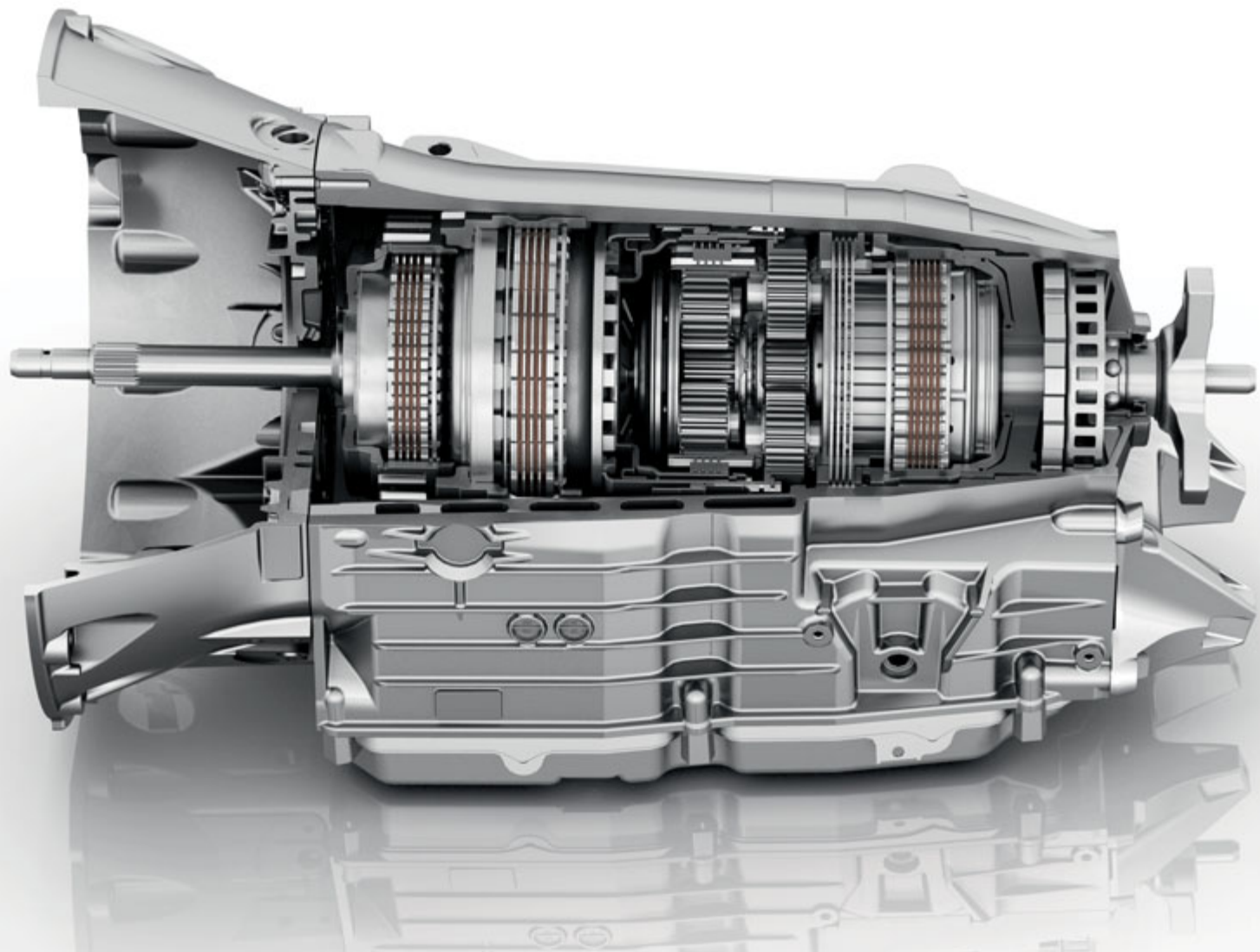

There are those who think the number seven has magical properties – our transmission developers, for example

Mercedes-Benz has always been associated with particularly refined and long-lasting automatic transmissions. Hardly surprising, perhaps, when you consider that, forty years ago, we were the first manufacturer to offer a car equipped with a hydraulic automatic transmission. Much has happened since then. And since the CLS is brimming with leading-edge technology throughout, all the models

are equipped as standard with the innovative 7G-TRONIC automatic transmission. Its seven forward gears and the resulting smaller shifts in engine speed translate into silky smooth gear changes without any perceptible interruption in power flow. There is also the option of steering-wheel shift paddles for even faster gear changes.

Sometimes it pays to be hard. Other times a softly, softly approach is called for

Whether it be rough cobblestones or a smooth motorway, effortlessly serene progress is assured courtesy of AIRMATIC DC. This semi-active air suspension system prevents uneven road surfaces from compromising ride comfort. You can choose from three suspension modes at the touch of a button: comfort, sporty comfort or sport. To ensure that the level of the vehicle remains constant, self-levelling suspension is also included. At higher speeds, the body is automatically lowered to reduce pitch and roll movements. This system is standard for the 8-cylinder models and can be ordered as an optional extra for the 6-cylinder versions.

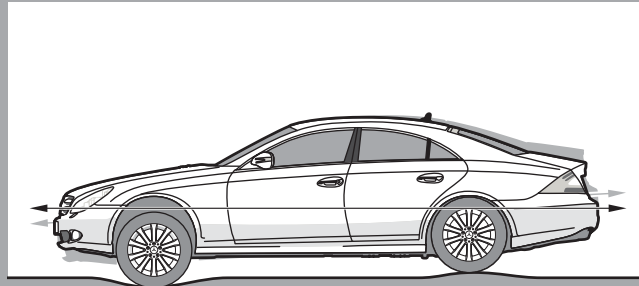

AIRMATIC DC adjusts the suspension response to your driving style, regardless of how laden the vehicle is, and thus offers even greater directional stability and road holding

AIRMATIC DC opens up a new dimension of comfortable and sporty driving. This is made possible by the adaptive damping system which continuously adjusts the firmness of the air suspension in accordance with the current driving situation. Instead of conventional coil springs, an electronic system adjusts the settings of the air springs by varying the air pressure to create a harder or softer set-up. Each spring strut has an additional volume of air which can be partially deactivated if necessary. If the sensors register a sporty driving style, for instance, the comfortable basic suspension automatically becomes firmer. The suspension set-up can also be adjusted manually

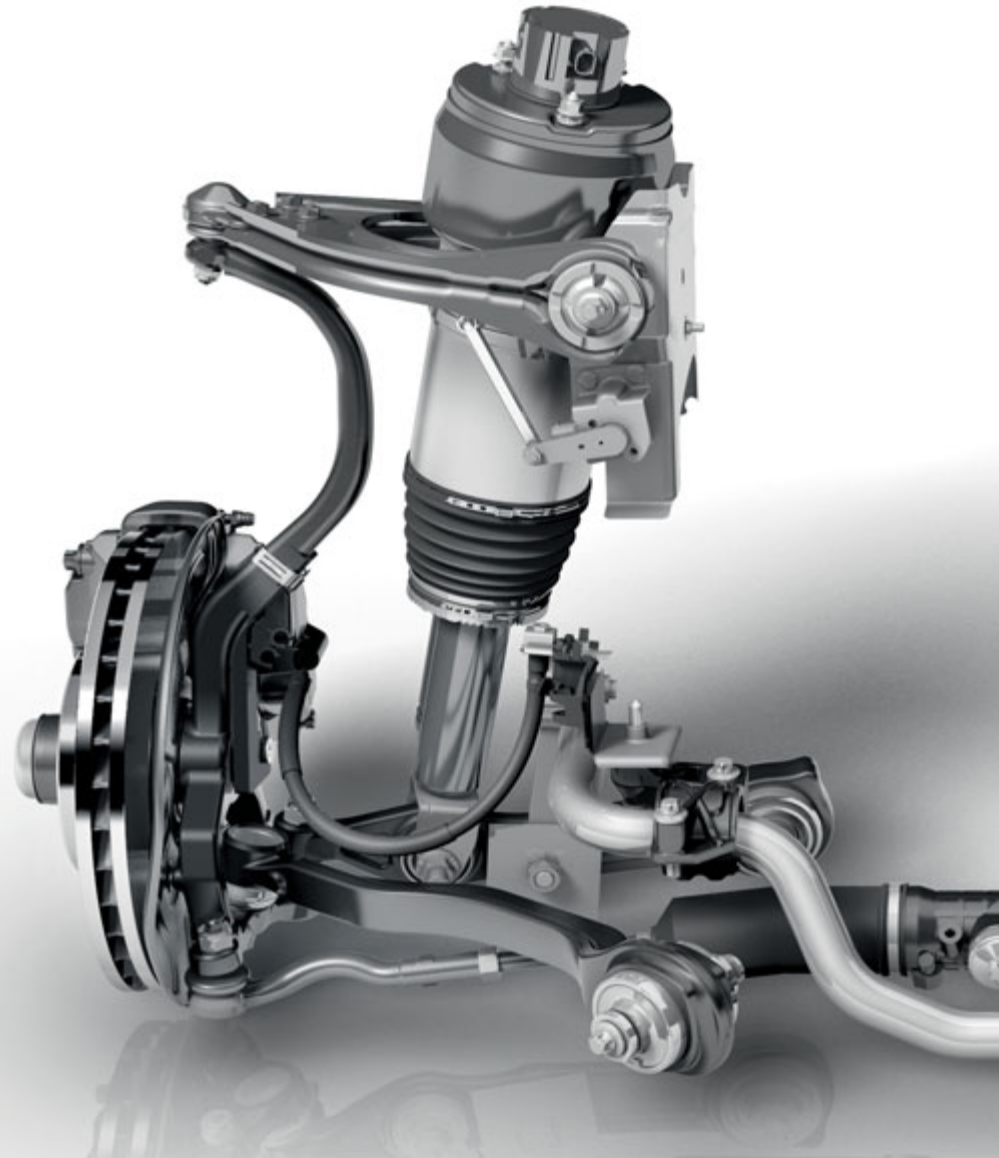

Before you set out on your journey, we set out to make it as safe as possible

The safety philosophy of Mercedes-Benz is an all-encompassing one that centres around the vision of accident-free driving: we call it the integral safety concept. The CLS is equipped with numerous assistance systems whose sensors continuously monitor the driving situation, identifying hazards and deploying the appropriate measures as required. Safety functions such as ESP®, ASR, ABS and BAS are, of course, standard in the CLS. In the event of a rear-end collision of a given degree of severity, the crash-responsive NECK-PRO front head restraints instantly move forwards and upwards in order to brace the head of the front seat occupants at an earlier stage. Depending on the type and severity of impact, the front airbags, sidebags and windowbags can be triggered selectively and inflated to differing degrees to suit the situation. The CLS is also equipped with the ADAPTIVE BRAKE system including the practical HOLD function, which holds the vehicle on

a slope without requiring the driver to maintain pressure on the footbrake. In the event of emergency braking, the adaptive brake lights alert traffic behind by flashing during the braking process. If the vehicle comes to a stop, the hazard warning lights are then activated.

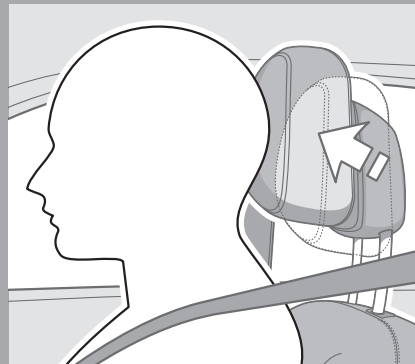

The crash-responsive NECK-PRO front head restraints can help prevent whiplash injuries

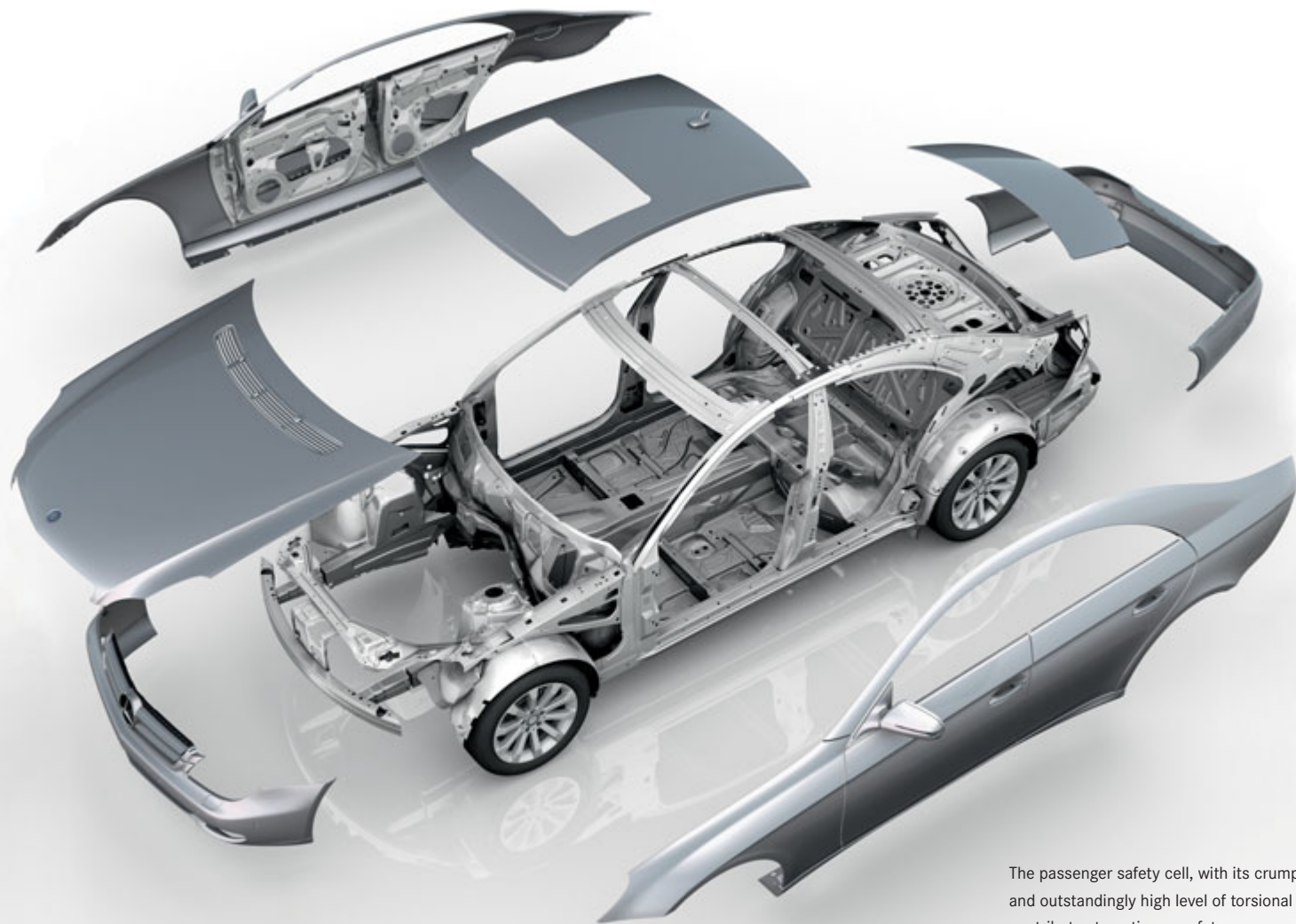

The passenger safety cell, with its crumple zones and outstandingly high level of torsional stiffness, contributes to optimum safety

Some lateral thinking by us means better visibility on bends for you

Driving on winding roads requires the utmost in concentration, especially at night. To make life much easier for you, the CLS comes with the option of bi-xenon headlamps, whose luminance is twice that of conventional halogen bulbs. The active light function (optional) allows the headlamps to follow the driver's steering movements, improving illumination on bends by up to 25%. Furthermore, the cornering light function is activated automatically as required, at speeds of up to 40 km/h, in order to boost the effect of the headlamps: when you start to turn the steering wheel, the fog lamp on the relevant side of the car is switched on in addition to the headlamps in order to ensure optimum illumination of the bend. The same thing happens when you indicate to make a turn. Bi-xenon technology also has further advantages in that the bulbs last much longer and use less energy than their conventional counterparts.

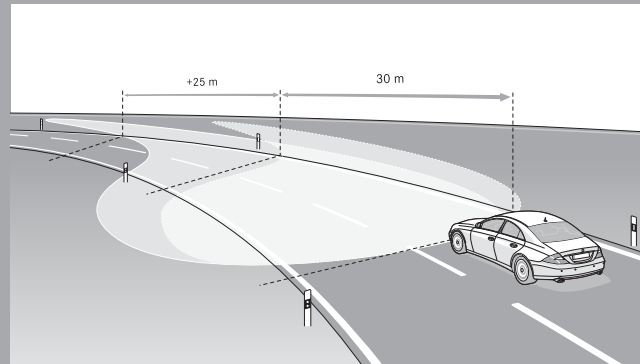

For drivers who feel that distance lends the best perspective

DISTRONIC measures the position and speed of the vehicle in front by means of a radar sensor behind the Mercedes star. These data are used to adapt the speed of your CLS (by adjusting the engine output and applying the brakes accordingly) in order to keep it at a set distance from the vehicle in front.





One of the quickest ways to upgrade from first class

You're torn between a coupé, a saloon and a thoroughbred sports car with performance to match? Then there is only one choice: the CLS 63 AMG. As well as offering you a supremely dynamic drive, it also boasts visual highlights such as distinctive 19-inch AMG triple-spoke light-alloy wheels. What's more, the AMG V8 powerplant unleashes a rated output of 378 kW and a tremendous 630 newton metres of peak torque. The CLS 63 AMG sprints from 0 to 100 km/h in just 4.5 seconds. Quite apart from performing like a top athlete, it looks like one too, cutting a dashing figure wherever it goes.

And thanks to its double-declutching function, the AMG SPEEDSHIFT PLUS 7G-TRONIC transmission makes for a compelling driving experience and for even greater directional stability when shifting down during cornering.



High-performance sport in its most aesthetic form



AMG sports steering wheel with rim in nappa leather

A wealth of sporty highlights await you inside the CLS 63 AMG too, including fine nappa leather upholstery on the exclusive AMG sports seats with Alcantara® inserts. The AMG sports steering wheel with aluminium shift paddles for manual operation of the AMG SPEEDSHIFT PLUS 7G-TRONIC is perfectly complemented by the AMG instrument cluster including RACETIMER.



AMG sports seats upholstered in fine nappa leather with Alcantara® inserts



The AMG performance steering wheel trimmed in nappa leather gives you a perfect hold over your CLS



Designed to keep the power on the road – forged 19-inch AMG twin-spoke light-alloy wheel



The AMG limited-slip differential enhances the driving dynamics by diverting superfluous drive torque when cornering or driving on uneven road surfaces

The AMG Performance Studio offers you a wealth of additional options for further enhancing your CLS 63 AMG, on both a technical and a visual level. These include the

AMG Performance package comprising internally ventilated compound brake discs with a diameter of 390 mm at the front, an AMG limited-slip differential at the rear

and forged spoke design. This package also includes the AMG performance suspension and an AMG performance steering wheel which feels as good as it looks.

A magnet for admiring glances in its standard form, the CLS 63 AMG can be given an even sportier appearance with optional AMG carbon-fibre trim elements and illuminated AMG door sill panels for the interior.

The Exterior Carbon-Fibre package can also be ordered as an option, encompassing carbon-fibre deflectors, a front apron, exterior mirror housing, a spoiler lip on the boot lid, plus the insert in the rear apron. For the ultimate in sporty looks.



Fashion moves with the times. AMG is ahead of them

The optional AMG bodystyling allows you to give any CLS model a sportier look. It comprises a distinctive front apron with large air intakes, a rear apron with a black insert, AMG tailpipes and AMG side sill panels. Attractive 19-inch AMG 5-spoke light-alloy wheels with a high-shine finish can also be ordered.





Exclusivity all the way

Whether it be a short trip or a long journey, you will always arrive feeling relaxed in the CLS. This is because comfort takes top priority in the interior. On the front seats, the seat position, seat height, backrest angle and seat cushion length can all be adjusted to suit individual requirements courtesy of the power seat adjustment function. As well as giving you full control over seat comfort, the CLS comes as standard with a 3-spoke steering wheel trimmed in nappa leather, which feels every bit as good as it looks. And whatever your surroundings, you'll always enjoy the view inside the cockpit, with the combination of the pinstripe background of the instrument cluster and the white dials creating a particularly sporty look.

“Grand Coupé” is a category that justifies comparisons with the world of grand hotels. First-class appointments can be expected as a matter of course. The car's interior offers practically everything you could wish for as far as stress-relieving comfort features are concerned. Its legroom, elbowroom and headroom are more generous than in just about any other coupé. The wide centre console can be used as a comfortable armrest, while the fine materials and high-quality workmanship throughout the extremely spacious interior create such an exclusive ambience that you could be forgiven for never wanting to get out again.

Some qualities only reveal themselves in the long run

A car designed to meet the highest customer expectations has to excel in many different areas. One of these is, of course, the way it performs on the road. But intelligent ergonomics and a satisfyingly high standard of comfort are scarcely less important. All four occupants of the CLS will be able to enjoy both – even on longer trips. This is because your passengers get a whole lot more than just their own doors. The rear compartment also boasts two comfortable individual seats that are extremely generous when it comes to elbowroom and legroom. And if you order the optional THERMOTRONIC luxury automatic climate control system, each passenger even gets their own separately controllable temperature zone.



The THERMOTRONIC luxury automatic climate control system also allows the rear occupants to choose their own temperature settings



Ideal surroundings for those who like to be in control

Audio 50 APS offers you DVD navigation with an arrow display and junction zoom. The sophisticated COMAND APS multimedia system is now even more user-friendly too. The functions can be operated using the ergonomically positioned input array on the centre console, while many

functions can also be controlled directly from the steering wheel. And if the voice-operated control system LINGUA-TRONIC is fitted, the audio, telephone and navigation systems become even easier to use.



The optional AUDIO 50 APS provides you with information about the many different functions that can be controlled with the system



The optional COMAND APS has even more interactive functions which are presented on a 6.5-inch colour display

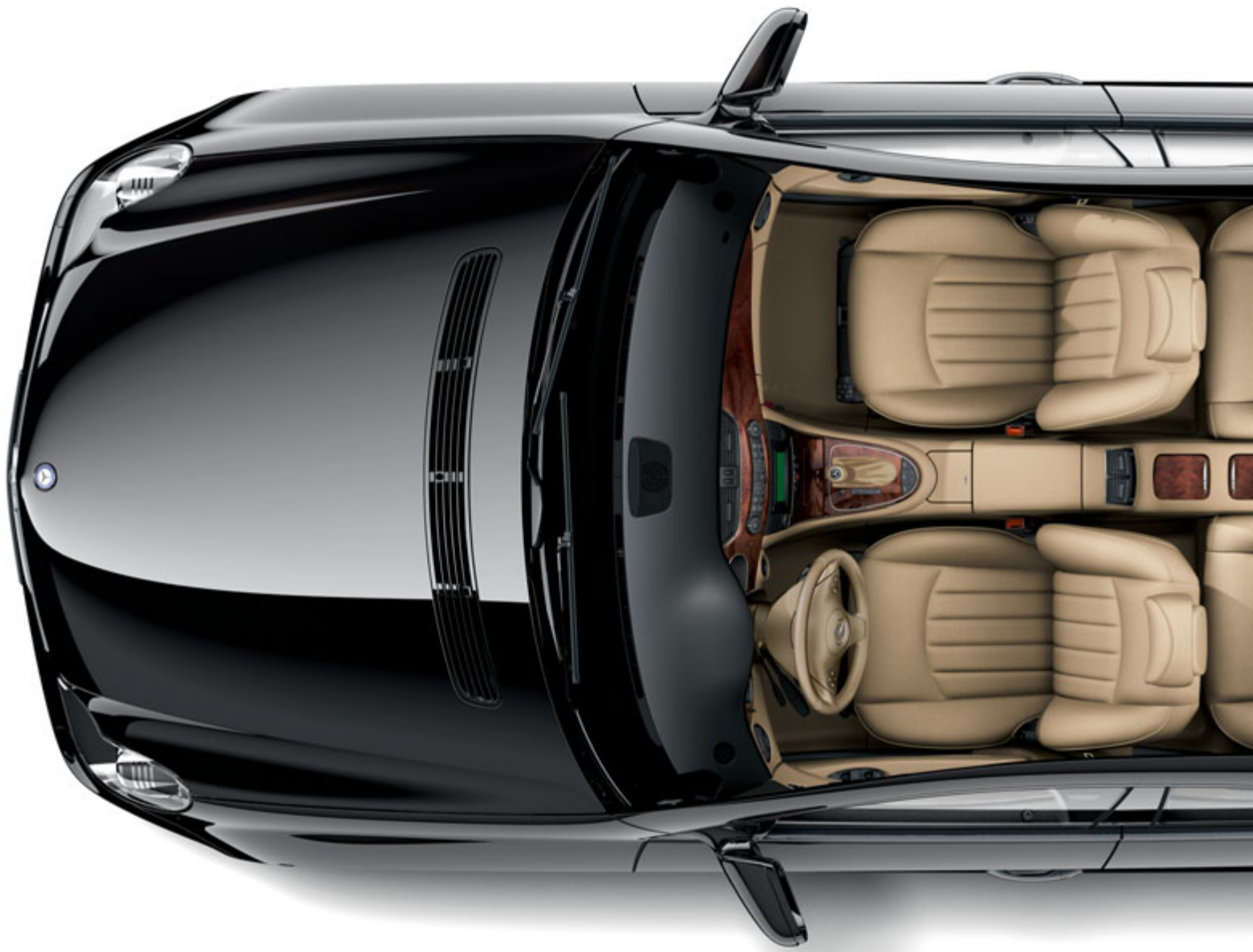

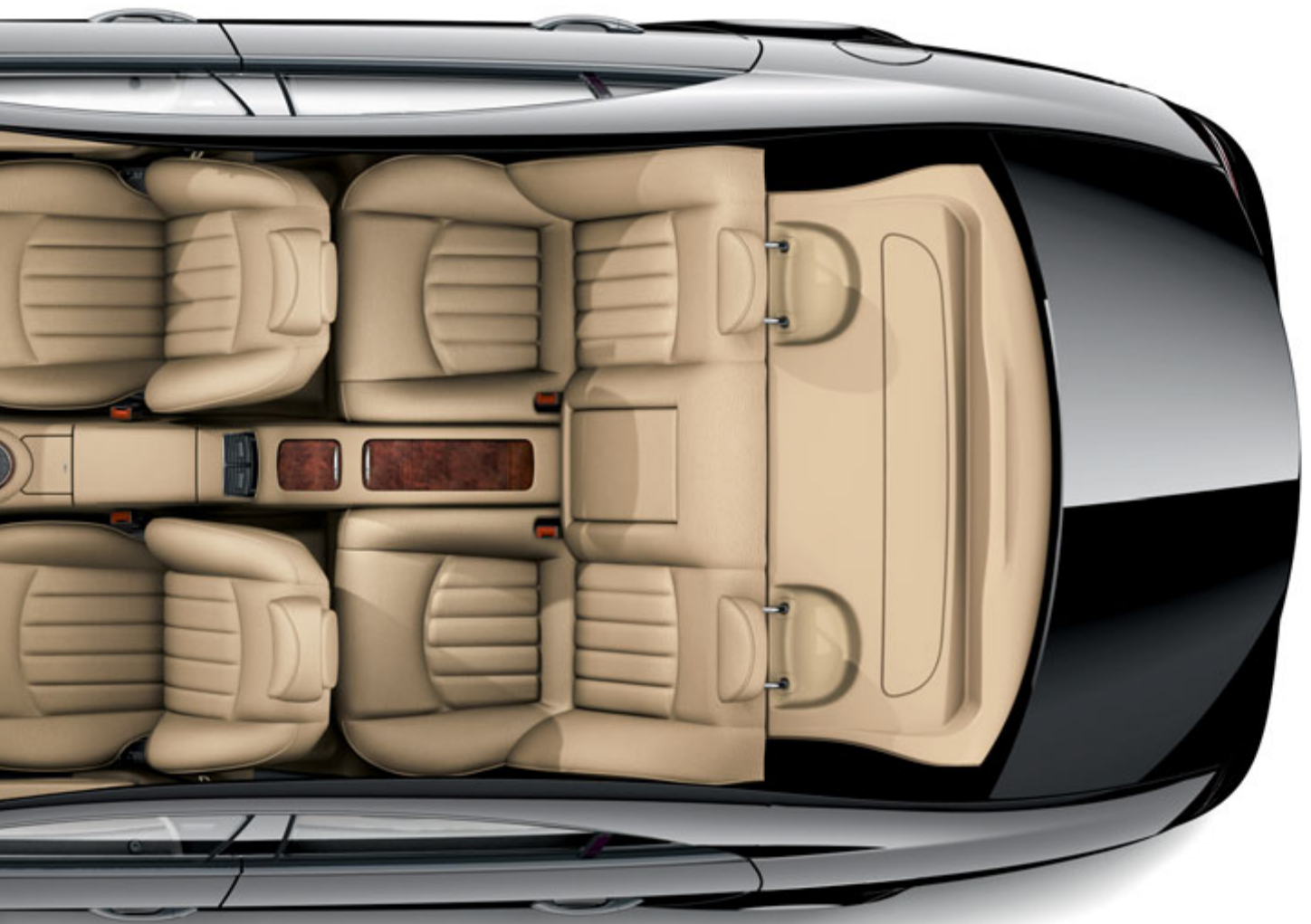

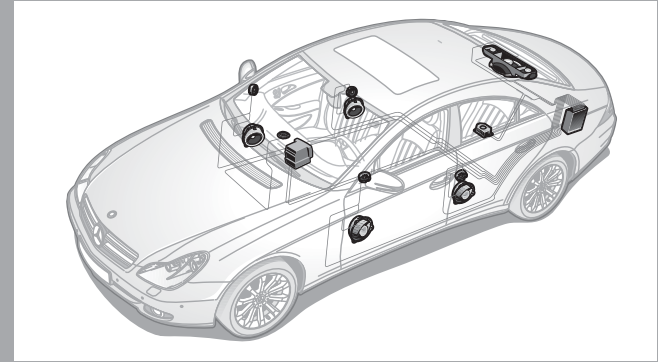

The loudspeakers of the Harman Kardon® Logic 7® surround sound system are specially matched to the interior of the CLS for optimum sound reproduction

The interior ambience of the CLS is everything you would expect of a Mercedes. In the rear, your passengers are accommodated in extremely comfortable individual seats separated by the continuation of the centre console. The latter is equipped with practical stowage compartments, while a particularly wide centre armrest can be folded down for even greater seating comfort. Outstanding workmanship and high-quality, exclusive materials also contribute

to the unique atmosphere which Mercedes-Benz has made synonymous with refined automotive comfort. And to make sure that all the occupants can enjoy an ideal listening experience, the CLS is equipped as standard with nine loudspeakers. This system can be extended to as many as twelve speakers with the optional Harman Kardon® Logic 7® or AMG high-end surround sound system.

It's already a thing of beauty. And now you can make it unique

No two people are alike. That is why we offer the comprehensive designo appointments range which allows you to design your CLS entirely in accordance with your own ideas and wishes. You can choose from a wide range of attractive metallic paint finishes, fine leather hues and high-quality trim parts.







A CLS with exclusive designo appointments is able to pander to just about your every desire. You can choose to have the seats and door centre panels finished in fine designo leather (shown here in designo porcelain, X27) or – for an even finer touch – in Exclusive designo leather. CLS models with Exclusive designo leather appointments



With Exclusive designo leather, the door centre panels are finished in the finest designo leather with attractive double topstitching

can be identified by the distinctive double topstitching in the door centre panels. Trim parts made from hand-selected woods or gleaming jet black piano lacquer create an exclusive, individualised ambience. The anthracite-coloured roof liner, available as an option in fine Alcantara®, provides the perfect finishing touch.



Available as an option: fine trim parts in designo black piano lacquer

My CLS





Luxury comes as standard in the CLS. But you can still take things a step further

The CLS is by definition a very luxurious vehicle. But you can still choose from a large number of optional functions and equipment items to make it even more luxurious and individual. Even in standard form, it comes with the Audio 20 CD radio system, a multifunction steering wheel trimmed in nappa leather, plus cruise control with the SPEEDTRONIC variable speed limiter. Other items of standard equipment are shown in the table on the next page.



The multifunction steering wheel allows the driver to use the telephone and the radio as well as to navigate through various vehicle functions in the instrument cluster display while keeping both hands on the wheel

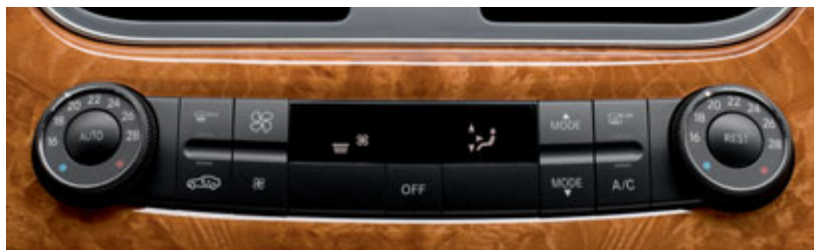

Fitted as standard in the 6-cylinder models, the THERMATIC air conditioning system with a combination filter and air recirculation switch ensures pleasant temperatures all year round in your CLS



The THERMOTRONIC luxury automatic climate control system offers extra functionality by allowing each of the four occupants to control the temperature in their own zone

Standard equipment (selection)

3-point seat belts, adjustable in the front, with automatic height adjustment in the rear
3-spoke sports multifunction steering wheel in nappa leather
7G-TRONIC automatic transmission
ADAPTIVE BRAKE with HOLD function
Airbags with multi-stage deployment logic and sidebags for driver and front passenger, plus windowbags
AMG SPEEDSHIFT PLUS 7G-TRONIC in the CLS 63 AMG
ASSYST PLUS service interval indicator with service computer
Audio 20 CD radio with telephone keypad, 9 loudspeakers, rear-window radio aerial
Brake Assist (BAS)
Cruise control and SPEEDTRONIC variable speed limiter with brake intervention
Electrically adjustable front seats

Electronic Stability Program ESP® with acceleration skid control
Head restraints (4): electrically folding in the rear, crash-responsive NECK-PRO versions in the front
Heated exterior mirrors, electrically adjustable, aspherical, with integral indicators
Integral safety concept
Particulate filter for CLS 350 CDI
Power windows (4) with one-touch control and obstruction sensor
Speed-sensitive power steering with safety steering column
THERMATIC automatic climate control in the CLS 350 CDI, CLS 300 and CLS 350 CGI
THERMOTRONIC 4-zone luxury automatic climate control in the CLS 500 and CLS 63 AMG
Tinted glass all round, rear window in single-layer safety glass
Windscreen wipers with one-touch function, rain sensor and infinitely variable intermittent setting

KEYLESS-GO allows you to unlock the CLS without touching the vehicle with the key, and also to start and stop the engine by means of a button on the selector lever. You can also order particularly comfortable active multicontour seats including the Memory package for the front. These are just two examples of how you can make driving the CLS even more pleasurable. Another option is the radar-based DISTRONIC proximity control, which automatically maintains a constant distance from the vehicle in front in order to take some of the strain out of driving.



The optional wood/leather steering wheel adds a particularly exclusive touch to the interior



Shift paddles on the steering wheel put sporty gear changes at the driver's fingertips



The start/stop button for the optional KEYLESS-GO system is located on the selector lever knob



The optional active multicontour seats can be individually adjusted to match the body's contours for even greater comfort

How about some crystal-clear competition for the sound of the engine?

The CLS is equipped as standard with the Audio 20 CD radio and nine loudspeakers, while the Audio 50 APS system is available as an optional extra. For the ultimate in ease of operation, you can also opt for the innovative COMAND APS multimedia system, which combines numerous functions in a single unit. COMAND APS makes it even easier to operate the radio, DVD player, navigation system and telephone. For supreme listening pleasure, we recommend the optional Harman Kardon® Logic 7® surround sound system with twelve metal-matrix loudspeakers and an output of 510 watts or the AMG high-end surround sound system with two ICEpower® digital amplifiers and an output of 705 watts.



The Audio 50 APS radio, including a CD drive, RDS tuner and telephone keypad, can be combined with the Harman Kardon® Logic 7® surround sound system as an option to form an exclusive stereo system



The AMG high-end surround sound system offers a listening experience of the very highest calibre



The optional sliding sunroof can be opened to admit fresh air at the touch of a button



The optional PARKTRONIC parking aid indicates the distance to obstacles



The optional Memory package stores the position of the front seats, the steering column and the exterior mirrors

Optional extras (selection)

Anti-theft alarm system with tow-away protection and interior monitoring

Active multicontour front seats

Audio 50 APS radio with DVD navigation system

Bi-xenon headlamps with active light function/cornering light function¹ in the fog lamps

Climatised front seats (with seat ventilation and heating), incl. luxury head restraints

COMAND APS multimedia system for radio/navigation

DISTRONIC

Headlamp cleaning system

Harman Kardon® Logic 7® surround sound system with 12 high-performance loudspeakers

KEYLESS-GO

Memory package for both front seats, steering column and exterior mirrors

Multifunction steering wheel with shift paddles

PARKTRONIC

Pre-installation for mobile phone in the centre-console armrest, including hands-free system and aerial

Semi-active air suspension (AIRMATIC Dual Control) for the CLS 350 CDI, CLS 300 and CLS 350 CGI

Sliding sunroof

THERMOTRONIC 4-zone luxury automatic climate control for the CLS 350 CDI, CLS 300 and CLS 350 CGI

Wood/leather multifunction steering wheel (leather variant can also be heated as an option)

¹ Cornering light function not available for the CLS 63 AMG

The light-alloy wheels



17-inch 10-spoke light-alloy wheels (standard for CLS 350 CDI, CLS 300 and CLS 350 CGI)



18-inch 5-spoke light-alloy wheels (standard for CLS 500, optional for 6-cylinder models, Code R96/R36)



18-inch 5-twin-spoke light-alloy wheels with high-shine finish and mixed-size tyres (optional extra, Code R70)



18-inch AMG 8-spoke light-alloy wheels with high-sheen finish and mixed-size tyres (optional extra, Code 33R)



19-inch AMG 5-spoke light-alloy wheels with high-sheen finish and mixed-size tyres (optional extra, Code 770)



18-inch 7-spoke light-alloy wheels, painted sterling silver, with mixed-sized tyres (genuine accessories)

Accessories

Whether you need to carry winter sports equipment or you just want to increase the stowage space, Mercedes-Benz genuine accessories are always the best choice because they are developed and tested in close cooperation with our engineers.



Attractive door sill panels make a clear statement of individuality



The chromed metal and plastic coat hanger fits simply onto the front head restraints to protect your jacket from creasing during the journey



The non-slip flat boot tub is easy to clean and helps to protect the boot of your CLS

The irresistible beauty of a beautifully resistant finish

The CLS paintwork puts the finishing touch to the carefully crafted Mercedes-Benz corrosion protection system, which includes zinc phosphating and electrophoretic dip-priming stages to ensure long-lasting protection. We also make very extensive use of eco-friendly water-based paints.

NON-METALLIC PAINTS

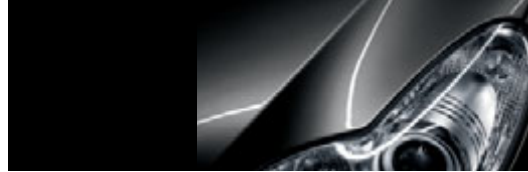

040 black

METALLIC PAINTS



197 obsidian black



300 periclase green



359 tanzanite blue



368 flint grey



775 iridium silver



799 diamond white BRIGHT



492 rutile brown



792 palladium silver



963 indium grey

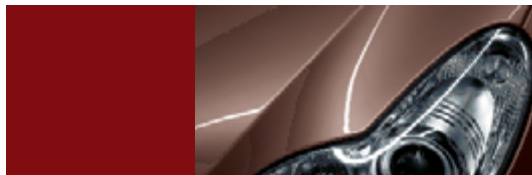

544 carneol red

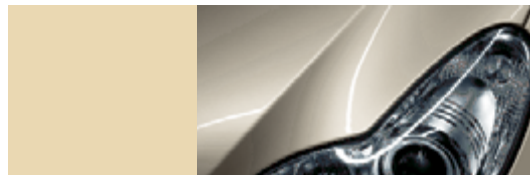

798 sandine beige

“Biarritz” FABRIC/LEATHER

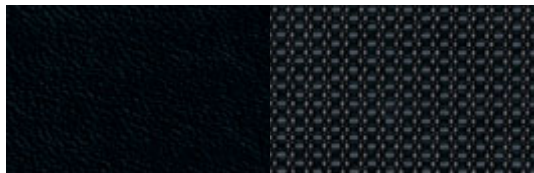

001 black

LEATHER optional extra¹

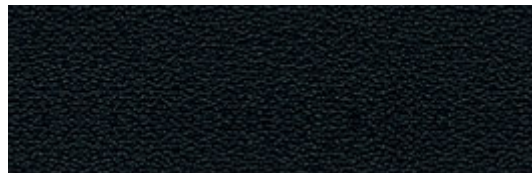

201 black

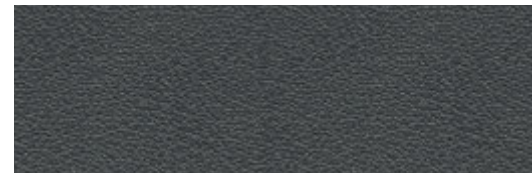

208 basalt grey

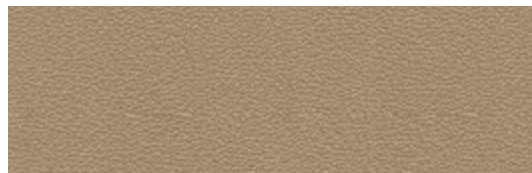

204 cashmere beige



207 sunset red

¹ Standard in the CLS 500

NAPPA LEATHER, Club-design optional extra/
EXCLUSIVE NAPPA LEATHER, Club-design optional extra



861/811 black



868/818 basalt grey

NAPPA LEATHER standard for CLS 63 AMG/
EXCLUSIVE NAPPA LEATHER optional extra for CLS 63 AMG



281/581 black

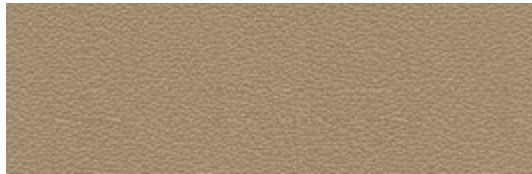

864/814 cashmere beige



284/584 cashmere beige



867/817 sunset red



288/588 basalt grey

TRIM PARTS

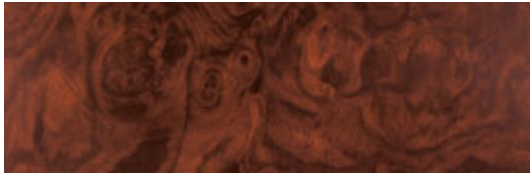

Silk matt burr walnut

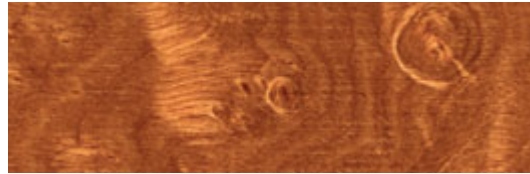
High-gloss chestnut¹High-gloss black bird's-eye maple¹High-gloss laurel¹¹ Optional extra



designo

designo

designo LEATHER

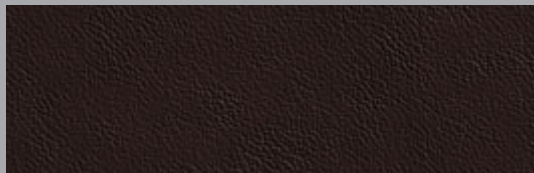

X06 marron



X13 mystic red



X17 classic red



X07 armagnac



X14 graphite green



X27 porcelain



X10 sand



X16 mauritius blue



X32 chablis

Details of the designo paintwork are available at www.mercedes-benz.com

designo TRIM PARTS



X49 corteccia



W21 oak grain, natural matt

designo ALCANTARA® ROOF LINER

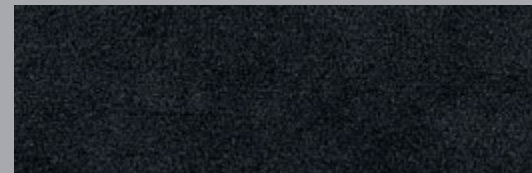

Y83 anthracite

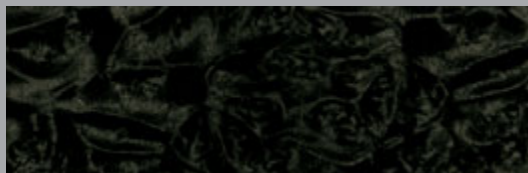

W66 maple grain, high-gloss umber

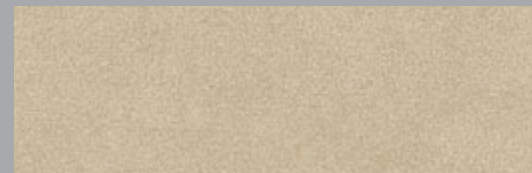

Y84 pebble beige

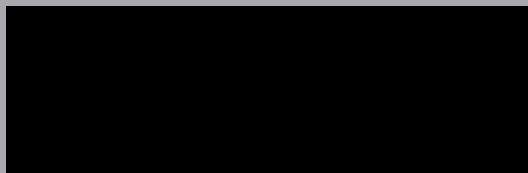

W69 piano lacquer, high-gloss black

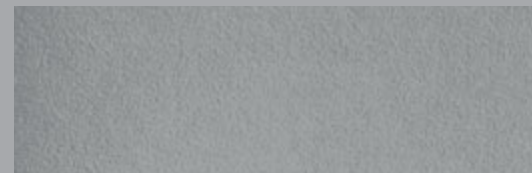

Y85 alpaca grey

Paintwork and upholstery – the combination options

	"Biarritz" FABRIC/LEATHER				LEATHER ¹				NAPPA LEATHER				
	black	black	cashmere beige	sunset red	basalt grey	black	cashmere beige	sunset red	basalt grey	black	cashmere beige	sunset red	basalt grey
NON-METALLIC PAINTS													
black	<input type="checkbox"/>	●	●	●	●	●	●	●	●	●	●	●	●
METALLIC PAINTS													
obsidian black	<input type="checkbox"/>	●	●	●	●	●	●	●	●	●	●	●	●
periclase green	<input type="checkbox"/>	●	●	△	○	●	●	△	○	●	●	△	○
tanzanite blue	<input type="checkbox"/>	●	○	△	●	●	○	△	●	●	○	△	●
flint grey	<input type="checkbox"/>	●	○	○	○	●	○	○	○	●	○	○	○
rutile brown	<input type="checkbox"/>	●	●	○	○	●	●	○	○	●	●	○	○
carneol red	<input type="checkbox"/>	●	●	△	○	●	●	△	○	●	●	△	○
iridium silver	<input type="checkbox"/>	●	○	●	●	●	○	●	●	●	○	●	●
palladium silver	<input type="checkbox"/>	●	△	●	●	●	△	●	●	●	△	●	●
sanidine beige	<input type="checkbox"/>	●	●	△	△	●	●	△	△	●	●	△	△
diamond white BRIGHT	<input type="checkbox"/>	●	○	●	●	●	○	●	●	●	○	●	●
indium grey	<input type="checkbox"/>	●	●	△	△	●	●	△	△	●	●	△	△

□ Standard

● Recommended

○ Possible

△ Not recommended

¹Standard in the CLS 500

Technical data

	CLS 350 CDI	CLS 300	CLS 350 CGI	CLS 500	CLS 63 AMG
No. of cylinders/arrangement	6/V	6/V	6/V	8/V	8/V
Total displacement (cc)	2987	2996	3498	5461	6208
Rated output ¹ (kW at rpm)	165/3800	170/6000	215/6400	285/6000	378/6800
Rated torque ¹ (Nm at rpm)	540/1600–2400	300/2500–5000	365/3000–5100	530/2800–4800	630/5200
Compression	17.7	11.3	12.2	10.7	11.3
Acceleration 0–100 km/h (s)	7.0	7.7 ²	6.7 ²	5.4 ²	4.5
Top speed, approx. (km/h)	246	245	250 ³	250 ³	250 ³
Tyre size	245/45 R 17	245/45 R 17	245/45 R 17	245/40 R 18	255/35 R 19 (front) 285/30 R 19 (rear)
Fuel	Diesel	Premium petrol	Premium petrol	Premium petrol	Super Plus
Fuel consumption ⁴ (l/100 km) Urban/extra-urban/combined	10.6–11.0/5.9–6.4/7.6–8.1	13.8–14.1/7.4–7.7/9.8–10.0	13.0–13.2/7.0–7.2/9.1–9.3	17.0–17.2/8.5–8.7/11.6–11.8	22.6/9.9/14.5
CO ₂ emissions ⁴ (g/km) combined	200–215	233–237 ⁵	217–222	275–280 ⁵	345
Tank capacity (l), incl. reserve, approx.	80/9	80/9	80/9	80/9	80/14
Turning circle diameter (m)	11.2	11.2	11.2	11.2	11.5
Kerb weight ⁶ (kg)	1815	1730	1735	1835	1905
Permissible gross vehicle weight (kg)	2280	2195	2200	2300	2370

¹ Figures according to Directive 80/1269/EEC in the currently applicable version

² On models with the optional multifunction steering wheel with shift paddles, the 0–100 km/h acceleration time is 0.2 seconds faster in manual shift mode

³ Electronically governed

⁴ The figures shown were obtained in accordance with the prescribed measuring process (Directive 80/1268/EEC in the currently applicable version).

The figures are not based on an individual model and do not constitute part of the product offer; they are provided solely for purposes of comparison between different vehicle models

⁵ Meets requirements of EU 5 emission standard

⁶ Figures according to Directive 92/21/EC, version 95/48/EC (kerb weight with fuel tank 90% full, driver, 68 kg, and luggage, 7 kg) for standard-specification vehicles.
Optional extras and accessories will generally increase this figure and reduce the payload capacity accordingly

The dimensions of the CLS

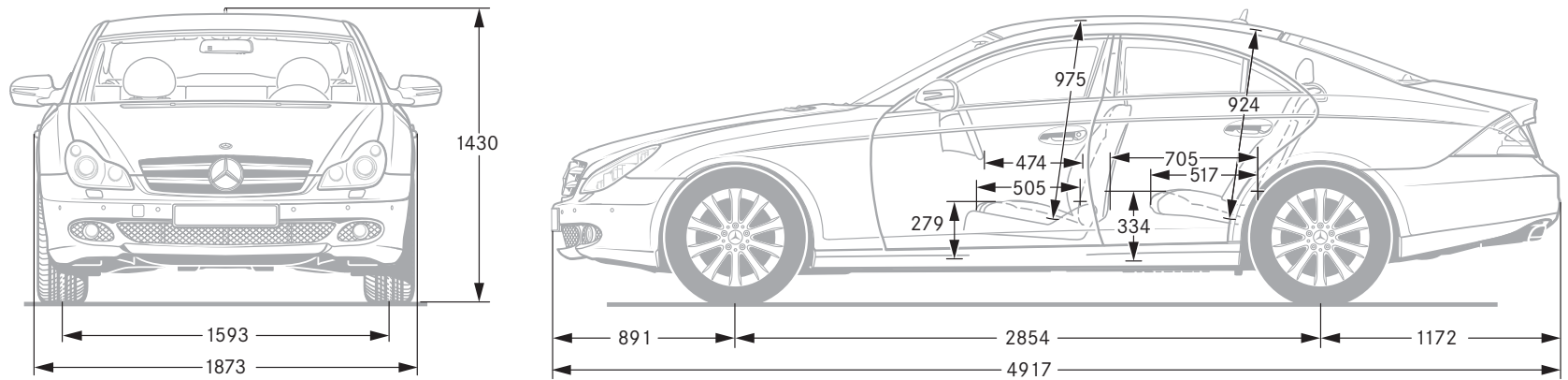

All measurements in millimetres. The dimensions shown are mean values and apply to standard-specification, unladen vehicles

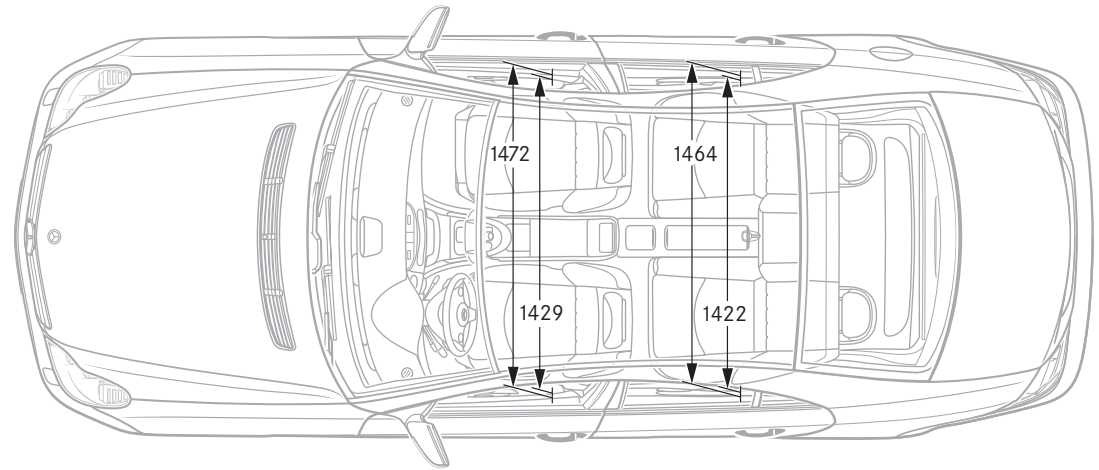
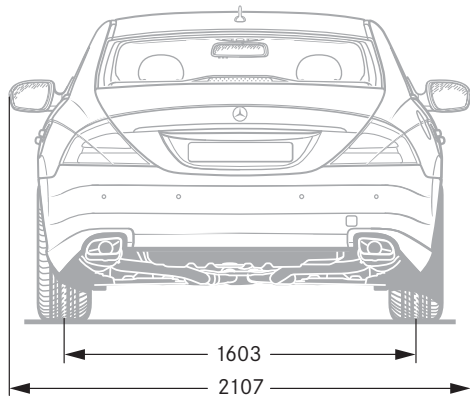



Anyone opting for a Mercedes buys far more than just a car

Mercedes-Benz mobility. There will always be a helpful passenger in your new car: the assurance of carefree driving. Should you ever need assistance, however, the Mercedes-Benz Service24h is there for you. Just call the freephone service hotline on 00800 1 777 7777¹. The newly integrated telematics service Mercedes-Benz Contact² is even more customer-friendly: a touch of a button is all it takes to contact the Mercedes-Benz customer centre by phone. And if you wish all the relevant vehicle and position-related data can be sent at the same time, ensuring the fastest possible reaction time and rapid on-the-spot help. As standard and at no extra charge: the Mercedes-Benz mobility package Mobilo³. Whether you have lost your key, have had a breakdown which cannot be repaired immediately or the vehicle is damaged as a result of an accident or vandalism, Mobilo gets you to your destination – anywhere in Europe. Whatever the nature of your problem, you will soon be able to resume your journey.

MercedesCard. Your ticket to the Mercedes-Benz experience: four times a year we will send you exciting details of a selected range of events and services which we have put together exclusively for you. Then there is the Mercedes Magazine with its fascinating reports and articles. But the MercedesCard also has many other uses: as a VISA credit card, it is an internationally accepted means of payment. Answer the annual questionnaire and we'll even waive the card fee. Plus the card offers further benefits to provide you with peace of mind, such as the Mercedes-Benz insurance package at no extra charge and the exclusively compiled MercedesCard insurance package at a preferential price. You can also gain free entry to the Mercedes-Benz Museum simply by showing your VISA MercedesCard. Further information can be found at www.mercedes-benz.de/mercedescard⁴

Mercedes-Benz Bank. If you have already chosen your dream car and want to remain financially flexible, you should make us your next port of call, whether it be for leasing, finance, insurance or service packages. Our “Private Leasing plus” scheme is a complete package comprising leasing, third-party insurance and fully-comprehensive insurance. “Business Leasing plus” for business customers works in much the same way, while our “Plus3 Financing” combines the low repayment rates of a financing scheme with the flexibility of leasing. You then have three options at the end of the contract: you can keep the car, sell it or return it to us for a guaranteed price and switch to a new model. We can also offer a range of investment products such as fixed-interest products, savings plans, investment funds or depository receipts. For details, please call 01803/32 22 65⁵ or visit www.mercedes-benz-bank.de

¹ Mobile phone rates vary according to service provider

² Requires a factory-fitted radio linked up to a switched-on mobile phone.
For the cost of a call to the landline network

³ When the warranty has expired Mobilo can be extended by another year for a maximum of 30 years, provided that regular maintenance is carried out by your Mercedes-Benz service partner

⁴ Information about the MercedesCard in Austria and Switzerland can be found on the Mercedes-Benz websites for these countries

⁵ 9 ct./min. from Deutsche Telekom landlines, mobile-phone rates may vary



Time for another enriching experience

A Mercedes-Benz is most at home on the road. This is the only way to experience the effortlessly superior driving feel that lends every Mercedes model its inimitable class. Feel the power of efficient engines with low fuel consumption and precise steering, designed to put you right in the mood for driving. And experience what true comfort really is. The unique feeling of driving a Mercedes cannot be put into words, however. Which is precisely why we'd like to invite you to take a test drive. Your Mercedes-Benz dealer will be happy to make all the necessary arrangements for you. Simply visit www.mercedes-benz.com to locate the nearest Mercedes-Benz dealer in your country or region. We look forward to seeing you.

The website also offers an interactive tour, enabling you to take a closer look at your desired model. This simulation is the ideal way to acquaint yourself with your dream car. You can view key functions in detail, gain an insight into the car's inner workings or look at the benefits of each model. For further details, visit www.mercedes-benz.de/owners-manual

Now your mobile phone acts as a gateway to the whole Mercedes-Benz world. In addition to an overview of all passenger car models, there are insights into the entire brand world, not to mention a wealth of entertainment offers and direct links to a range of services at www.mercedes.mobi

Take-back of end-of-life vehicles. Coming full circle. At the end of its long life, you can return your CLS-Class to us for environment-friendly disposal in accordance with the EC End-Of-Life Vehicle Directive¹. But that day lies a long way off.

¹ Applies in accordance with national regulations to vehicles up to 3.5 tonnes gross weight. Mercedes-Benz passenger cars have met the statutory regulations governing the suitability of their design for reuse and recycling for a number of years now. A network of vehicle take-back depots and dismantlers has been established which will process your vehicle in an environment-friendly manner. The ways in which both vehicles and parts can be recovered are subject to ongoing development and improvement. Consequently, the CLS-Class will be able to comply with any future increases in the recycling quota within the stipulated time limits. For further information, please call 00800 1 777 7777.

Please note: changes may have been made to the product since this brochure went to press (04.09.2009). The manufacturer reserves the right to make changes to the design, form, colour and specification during the delivery period, provided these changes, while taking into account the interests of the vendor, can be deemed reasonable with respect to the purchaser. Where the vendor or the manufacturer uses symbols or numbers to describe an order or the subject of an order, no rights may be derived solely from these. The illustrations may show accessories and items of optional equipment which are not part of standard specification. Colours may differ slightly from those shown, owing to the limitations of the printing process. This brochure has been compiled by Daimler AG of Germany and is distributed internationally. It provides a general indication of the range of models, features, optional extras, colours and/or services available in various countries. Some of the models, features, optional extras, colours and/or services may not be available in your country, or may only be available in a different specification. Additionally some models, features, optional extras, colours and/or services may only be available in combination with others. For current and more specific information in relation to the range of models, features, optional extras, colours and/or services available in your country, and their pricing, you should contact your nearest authorised Mercedes-Benz Passenger Car Dealer. www.mercedes-benz.com