



A-Class

Mercedes-Benz

“Our philosophy is very simple. We give our best for people who expect the best.”

Dr Dieter Zetsche

Contents

The A-Class	3	My A-Class	32
Exterior design	6	Equipment	34
Agility	14	Standard	34
Efficiency	14	ELEGANCE line	36
ECO start/stop function	16	AVANTGARDE line	38
Petrol engines	18	Comfort package	40
Diesel engines	20	Sports package	42
AUTOTRONIC	22	Standard	44
Safety	24	Optional extras	48
Active safety	24	Light-alloy wheels	56
Passive safety	26	designo	58
Comfort	28	Genuine accessories	60
Interior of 5-door model	28	Colours and materials	62
Flexibility	30	Paintwork	62
		Upholstery, leather and trim parts	64
		Combination options	66
		Technical data	67
		Services	70

Greatness in a compact form: the A-Class

If carbon is compressed, the result is a valuable diamond. If the Mercedes-Benz philosophy is compressed, the result is a car like the A-Class, whose intrinsic value lies in its unique vehicle concept. Compact on the outside, the A-Class displays all the major attributes of a Mercedes-Benz: efficient use of space, outstanding safety, unrivalled variability and quality right down to the last detail.

Experience everything that makes a Mercedes-Benz special – experience the A-Class.





The essence of driving

Reliability *par excellence*

Precision-engineered quality

The art of engineering reaches its pinnacle when the gap between rationality and seduction is bridged. When outstanding practicality goes hand in hand with aesthetic pleasure. The one-box concept that forms the basis of the A-Class, including a raised sitting position and a large, versatile interior as well as compact dimensions, sets the standard in this segment.

The dynamic design gives the A-Class a longer and wider presence. The powerful overall impression is further reinforced by the distinctive bumpers and the large exterior mirrors painted in the vehicle colour. A radiator grille with a pronounced V-shape and the sweeping form of the drop-shaped clear-glass headlamps add to the sporty aura and send out a clear message: the A-Class is ready. Are you?







Extremely easy on the eye

The exclusive design of the A-Class

A strong silhouette: from the sharply rising front section and the dynamic curve of the roof to the steep angle of the tailgate - the A-Class boasts a striking and unmistakable profile. The short aerial and the exterior mirrors and door handles painted in the vehicle colour are designed for maximum appeal. Viewed from any angle, the interplay between the softly undulating surfaces and sharp edges stirs the emotions.

When viewed from the rear, too, the A-Class displays all that is good about sophisticated automotive design. Thanks to the flat tail lights and distinctive bumper, the car adopts a wide, confident stance on the road, poised to spring into action at any moment. Indulge yourself in sheer driving pleasure. All you have to do is turn the key.



Opt for greater freedom of choice

The variation options

Only you yourself can know what you really want. That's why the A-Class gives you the choice. Will it be the sporty elegance of the coupé, with its exciting and dynamic side lines? Or do you perhaps prefer the comfort and versatility of the 5-door saloon?

Then there are the two design and equipment lines. Once again, the choice is yours. Just as it should be. Whether it be the comfort-oriented standard version, the stylish ELEGANCE line or the sporty AVANTGARDE line, the A-Class gives you everything. Apart from compromises.





An investment in your future. And everybody else's

The A-Class: everything a car of today should be

The A-Class succeeds in reconciling attributes that, on the face of it, seem to contradict each other. Despite the compact exterior dimensions, the interior is extremely spacious, while the safety and comfort levels set standards in the entire compact class. Yet the unique vehicle concept at the heart of the A-Class goes way beyond the front and rear aprons. Those who drive it not only demonstrate a highly discerning nature when it comes to choosing a car. They also display environmental awareness. That's because the A-Class is made from recyclable materials such as steel, light alloy and plastic, while the seats contain renewable raw materials like coconut fibres. Numerous measures have been implemented to drastically reduce emissions during production. State-of-the-art, fuel-saving engines with lower CO₂ emissions and the standard-fit ECO start/stop function for the A 160 BlueEFFICIENCY and A 180 BlueEFFICIENCY models also play a key role in protecting the environment.





Innovations for efficient mobility

Climate change is one of the major challenges of the 21st century. The rising consumption of natural resources is having an increasing impact on our planet. As the inventor of the motor car, Mercedes-Benz has a special responsibility to implement innovative technologies in order to develop solutions that help preserve the environment and ensure that raw materials are used as efficiently as possible – without compromising on comfort, safety and driving enjoyment.

Our aim is zero-emission mobility. To help us achieve this goal, we have developed a range of concepts, such as the **BlueEFFICIENCY** technologies. These custom-designed efficiency packages can cut fuel consumption by up to 12 %. Each model features a raft of bespoke aerodynamic and energy-management measures, with the goal of maximising savings across the board. These measures include tyres with low rolling resistance, lightweight materials, an aerodynamic body shape and the ECO start/stop function available for selected models. As for

diesel, Mercedes-Benz has brought to market its **BlueTEC** technology, based on common-rail direct injection (CDI). It epitomises the world's cleanest diesel as, in addition to reducing particulate emissions by over 95 percent, it can also reduce nitrogen-oxide emissions. **HYBRID technology** – a combination of highly efficient internal combustion engine and electric motor – is also highly promising. Vehicles equipped with this drive system scale new heights in terms of cleanliness and cost-effectiveness, as highlighted in truly impressive fashion by the S-Class.

BlueTEC HYBRID is the name Mercedes-Benz



BlueTEC. The M-Class, R-Class and GL-Class will be available with BlueTEC technology from autumn 2009

gives to the combination of sophisticated hybrid and diesel technology. It allows us to marry the benefits of a hybrid-driven car with those of BlueTEC technology. For intelligent energy management measures and low emissions. Mercedes-Benz also sees great potential in its research being carried out into electric drive systems offering everyday practicality, based on the high-voltage lithium-ion battery. Mercedes-Benz has unveiled three drive configurations based on one vehicle architecture as part of its close-to-production **Concept BlueZERO**: battery-electric drive, battery-electric drive plus



BlueEFFICIENCY technologies. Various models, different approaches, one aim: the highest possible efficiency

internal combustion engine for on-board power generation and fuel-cell drive – due to enter small-scale production as the B-Class **F-CELL** in 2010.

However, there is more to our extensive line-up of concepts for efficiency than just new drive technologies. Under the banner **Design for Environment**, we look at the vehicle's entire life-cycle – from planning to recycling. The same applies to the building and running of new plants. We save energy, avoid pollutants and open up new fields of application for the use of renewable raw materials in the automotive industry. Inci-



HYBRID technology. Already available (since summer 2009) in the S-Class: one of the world's most economical luxury saloons

dentally, Mercedes-Benz is the world's only car brand to have received the independently awarded German Technical Inspection Authority¹ environmental certificate. The Group and its employees also play an active role in supporting comprehensive environmental protection measures both inside and outside the company's plants. What's more, Mercedes-Benz is involved in the development of second-generation alternative fuels (BTL/biomass-to-liquid fuels), such as SunDiesel[®], which are not at odds with food production. Another aspect of our environmental activities is the research discipline of bionics, which



Concept BlueZERO. Three approaches to the future of zero-emission vehicles offering everyday practicality

looks at structures and designs in the natural world in order to optimise the weight and aerodynamics of body constructions, for example. Last but not least, you can also do your bit for the environment by adapting your driving style.

¹ SOUTH GERMAN TECHNICAL INSPECTION AUTHORITY Management Service GmbH, Munich



F-CELL. Emission-free mobility with the drive system of the future: the B-Class F-CELL goes into production in 2010



S MB 6543

When the lights are red, your engine goes green

Switch off and save: the ECO start/stop function

Even powerful engines like to switch off once in a while – especially in order to help the environment. The A 160 BlueEFFICIENCY and A 180 BlueEFFICIENCY models are equipped with the ECO start/stop function as standard. Whether it's at the lights, in stop-and-go traffic or when stuck in jams, this function can reduce fuel consumption by up to 9 %. After all, if the engine's not running, the vehicle can't produce any emissions.

The principle is simple: if you move the shift lever to neutral when travelling at walking pace, the ECO start/stop function will switch off the engine automatically. As soon as you engage a gear or release the brake pedal, the engine starts again. What's more, this happens so quickly and quietly that you barely notice it – although the low fuel-consumption figure might give the game away. By way of example the petrol-powered A 160 BlueEFFICIENCY model with a rated

output of 70 kW (95 hp) consumes just 6.0 to 6.2 litres of fuel per 100 kilometres, while the A 180 BlueEFFICIENCY model developing 85 kW (116 hp) returns a figure of just 6.3 to 6.6 litres per 100 kilometres (combined figures in each case). So these models are kind on your pocket as well as on the environment.



In the BlueEFFICIENCY models numerous fine-tuning measures result in reduced fuel consumption and CO₂ emissions

A 160 BlueEFFICIENCY

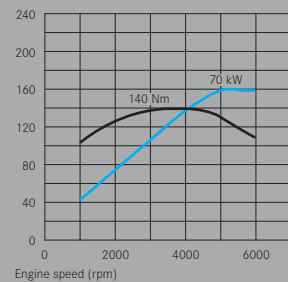

A 180 BlueEFFICIENCY

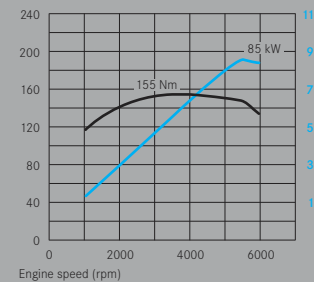

— Torque (Nm) — Output (kW)

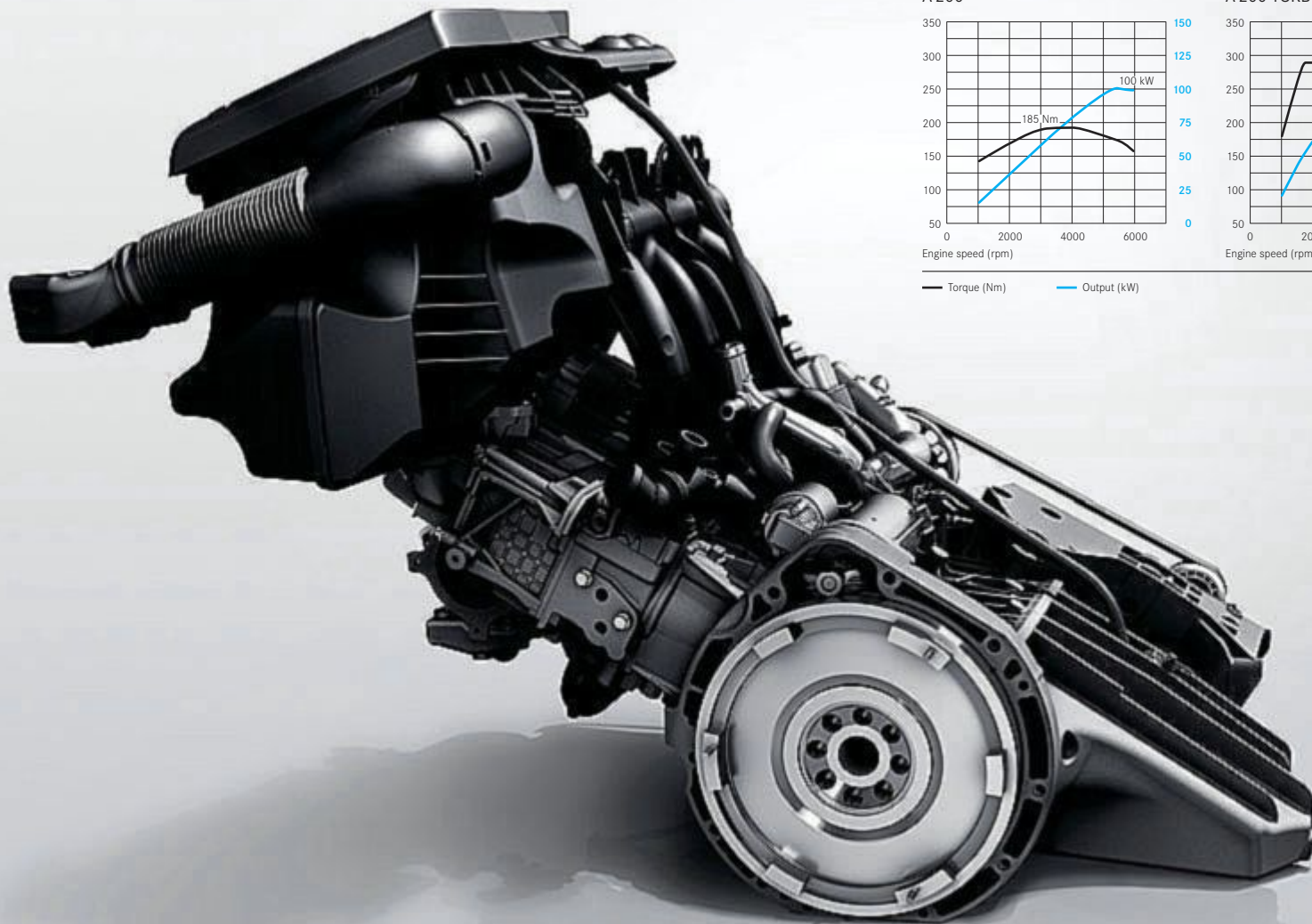

A 200

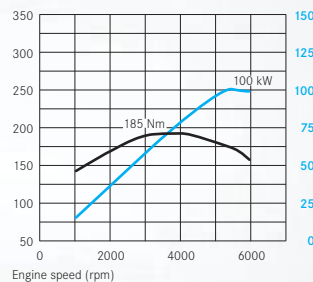

A 200 TURBO

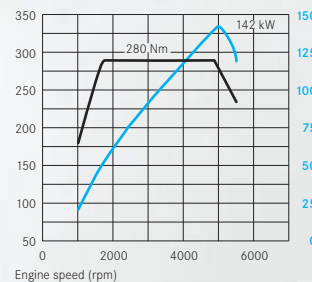

— Torque (Nm) — Output (kW)

Our engineers have invested a lot of energy. So you need less fuel

High on agility, low on consumption: the petrol engines

All of the A-Class engines have been attuned to the compact vehicle form. With space at a premium, the horsepower is itching to be unleashed. Not least in the A 200 TURBO, with its peak torque of 280 Nm at 1800 to 4850 rpm. When the accel-

erator is pressed, this top-of-the-range engine develops a hefty 142 kW (193 hp). The A 200 is similarly impressive, drawing on its output of 100 kW (136 hp) and 185 Nm at 3500 – 4000 rpm to make highly agile progress.

Despite their high power, the top A-Class engines save on fuel. Low friction losses in the engine and a high compression ratio help to keep consumption figures down.



With power comes responsibility

More responsive and kinder to the environment: the diesel engines

Preserving the environment is one of our top priorities. This is why our engineers work tirelessly to further improve our already efficient and environmentally friendly diesel engines. There are three diesel-powered A-Class models to choose from: the A 160 CDI BlueEFFICIENCY with 60 kW (82 hp), the A 180 CDI with 80 kW (109 hp) and the A 200 CDI with 103 kW (140 hp). A particulate filter which reduces particulate emissions by up to 95 % is standard for all the diesel engines.

The A 160 CDI with the AUTOTRONIC continuously variable automatic transmission impresses with excellent figures not only for fuel consumption but also for exhaust and noise emissions. This model's fuel consumption of 5.4 to 5.8 litres per 100 kilometres represents a CO₂ level of 142 to 154 g/km – an outstandingly low figure for a vehicle with an automatic transmission.

The A-Class models with manual transmission are particularly kind to the environment. As a result of the numerous

enhancements made to the entire vehicle, it has been possible to reduce the fuel consumption of the A 160 CDI BlueEFFICIENCY still further to its current level of just 4.5 litres per 100 kilometres (CO₂ emissions: 118 g/km). With a combined fuel consumption of 5.1 litres per 100 kilometres, the A 200 CDI is extremely economical yet still offers an output of 103 kW (140 hp) and an impressive 300 Nm of torque.

A 160 CDI BlueEFFICIENCY

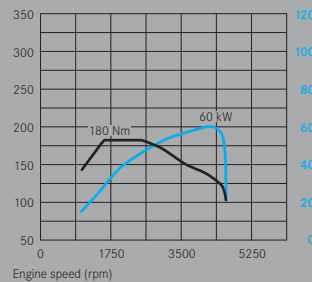

A 180 CDI

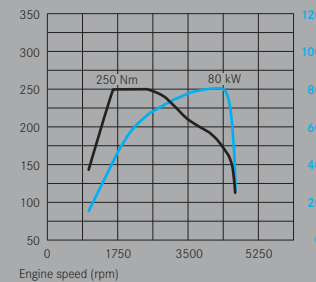

A 200 CDI

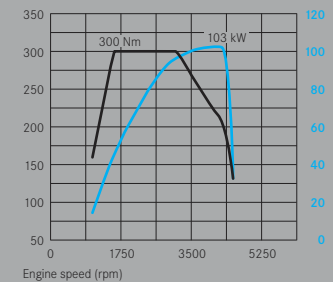

— Torque (Nm) — Output (kW)



We don't like to interrupt

Sophisticated transmission technology for faster gear changes

As a driver, do you prefer sporty performance or relaxed cruising? Or is it a case of sometimes one, sometimes the other? Whichever driving style you prefer, the A-Class offers you smooth and easy gear changes. Standard equipment for the A 160 BlueEFFICIENCY, A 180 BlueEFFICIENCY, A 200 and A 160 CDI BlueEFFICIENCY models includes a 5-speed transmission that has been

specially optimised for the engines, while the 6-speed manual transmission fitted as standard in the A 180 CDI, A 200 CDI and A 200 TURBO models ensures agile driving pleasure in every rpm range. For even easier shifts, the AUTOTRONIC continuously variable automatic transmission, available as an optional extra, recognises your personal driving style and adjusts the engine speed

accordingly. Thanks to the infinitely variable ratio, you accelerate without any interruption in tractive power, meaning that the engine can send its power to the front wheels continuously and, therefore, operate in the optimal range at all times. Things get decidedly sporty when manual mode is selected, since you can then change between several virtual gears by simply nudging the selector lever.







Many people believe in guardian angels. We believe in sophisticated safety technology

Active safety technology

Our aim is to make sure that you arrive at your destination safe and sound. This is why our engineers work tirelessly to make the A-Class even safer than it already is. Despite its compact exterior dimensions, it is packed with the latest safety technology from Mercedes-Benz. Numerous active safety systems – for example, the Electronic Stability Program ESP® and acceleration skid control ASR – help you to remain in better control right from the start in dangerous driving situations. If you brake quickly but not heavily enough in an emergency, Brake Assist (BAS) helps to build up the maximum braking pressure. Yet even when the full braking power is applied, the wheels do not lock up, since the familiar anti-lock braking system (ABS) meters the braking power precisely, meaning that the car remains steerable.

Plus the A-Class now features adaptive brake lights as standard: in the event of an emergency stop when travelling at over 50 km/h, the brake lamps start flashing several times a second so as to warn any vehicles behind, thus potentially

shortening their stopping distance decisively. If the A-Class is braked to a halt from a speed of 70 km/h or more, the hazard warning lights are switched on automatically, giving you an extra level of protection.

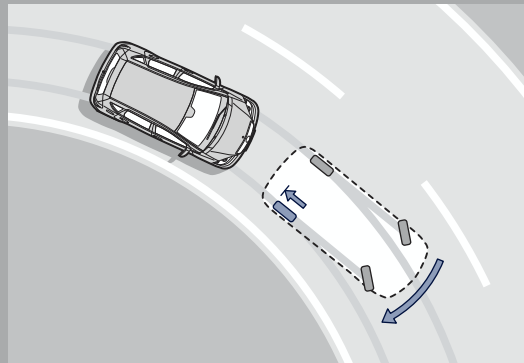

ESP® | Brake application in the event of understeer

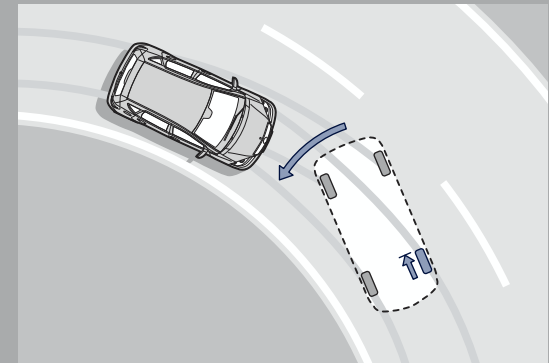

ESP® | Brake application in the event of oversteer

Superb protection you can count on. From the moment you take your seat in the A-Class

Passive safety technology

Even in an emergency, you can count on the A-Class, of course. Its high level of safety is partly down to its form: in the event of a frontal impact, the engine and transmission slide along the inclined pedal floor and under the passenger compartment. This intelligent form of crumple zone reduces the risk of occupant injury substantially.

If there is a rear impact, the front head restraints are activated so as to help prevent whiplash injuries. Here the distance between the occupant's head and the head restraint is shortened in order to reduce whiplash of the head. Further standard equipment includes crash-responsive emergency lighting: when pyrotechnic restraint systems (e.g. airbags or belt tensioners) are deployed in the event of an accident, the interior lighting

is activated if the interior lighting system is set to automatic. If the optional Light and Sight package is ordered, the footwell lighting is also switched on. So you can be confident of being

found in an emergency. Further information on the Mercedes-Benz safety concept can be found on the internet at www.mercedes-benz.com/airbag-brochure

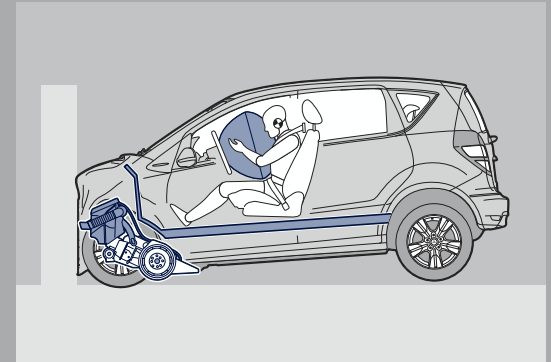
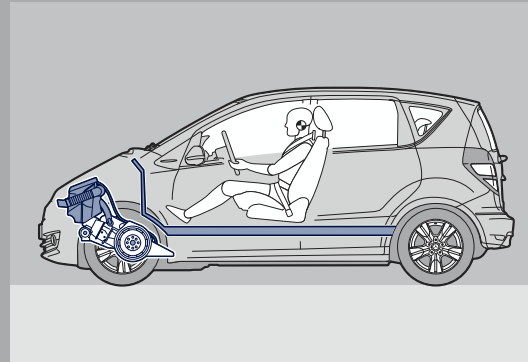





We wish you a pleasant stay

The interior

Regardless of where you sit, you're sure to find your favourite seat as the A-Class provides plenty of room to relax for all those on board. The large windows all round allow light to flood into the interior, while the optionally available panoramic louvred sunroof opens up the view of the sky above. A wealth of comfort and convenience features see to it that you arrive at your destination feeling relaxed, even after a long drive. Standard equipment includes air conditioning and an on-board computer as well as a multi-function steering wheel and Hill-Start Assist. The four clearly arranged dial-type instruments in the high-quality cockpit are ideally positioned within the driver's field of vision. Ergonomically designed seats relieve the strain on the spinal column and prevent drowsiness. In addition to all of this, the high-grade materials used in the A-Class provide a level of comfort that one could only expect of a Mercedes-Benz.



Plans change. But we've even planned for this

Room for ideas: EASY-VARIO system and EASY-VARIO-PLUS system

Variability is a constant in the A-Class. Should you require a completely flat load space with no boot sill to get in the way, the EASY-VARIO system (standard for the saloon and available as an option for the coupé) allows you to simply raise the cushions of the rear seats, fold the backrests forwards and move the height-adjustable load compartment floor into its higher position. The 1 : 2 split-folding rear seats are standard, so you can fold down the right-hand section of

the rear-seat unit and still carry a rear passenger on the left, for example. If you need more space, the optional EASY-VARIO-PLUS system lets you remove the rear seats and front passenger seat from the saloon entirely, giving you up to 1995 litres of load capacity. And even if you don't use any of the numerous conversion or removal options, the saloon still has enough room for five people, four suitcases, a sports bag and a beauty case.

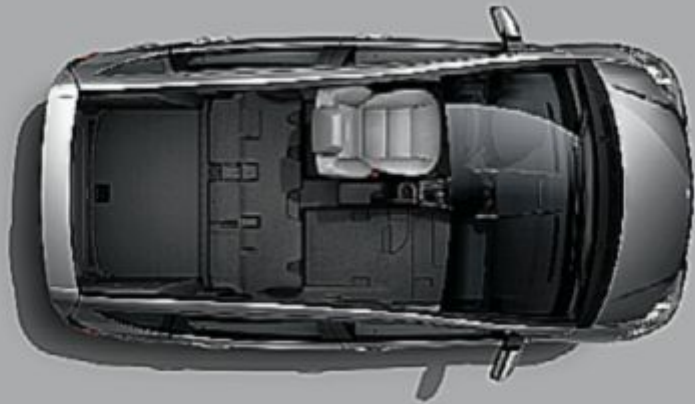
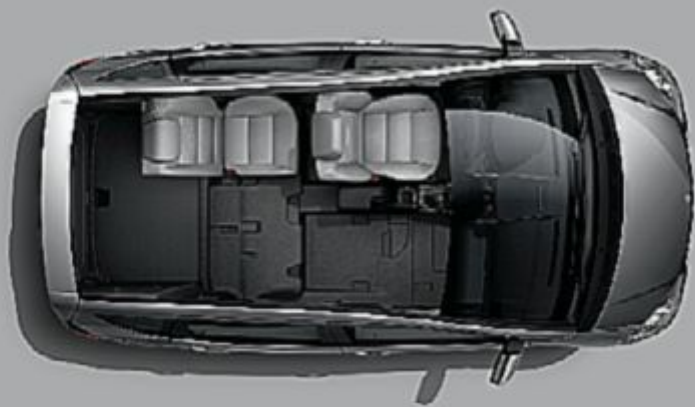





My A-Class

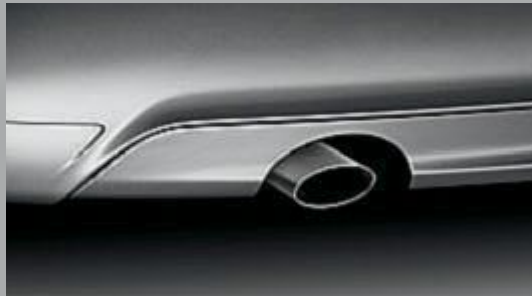

Standard equipment for the A-Class

The A-Class offers you that all-important extra degree of comfort as standard. The bumpers and the housings for the larger exterior mirrors painted in the vehicle colour enhance both style and sophistication, as do the door handles, which are likewise painted in the vehicle colour. At the front end, the radiator louvres painted in dark grey and the attractive clear-glass reflectors add further touches of refinement, while 15-inch wheel trims featuring a 7-hole design and optional 16-inch 7-spoke light-alloy wheels round off the classic appearance perfectly.

Moving inside, the high-gloss black trim strips contrast well with the seat upholstery, which is available in a choice of Mechelen or Namur fabric. The power windows, including one-touch up and down control for the front windows, can be fully opened or closed automatically by briefly pressing a button. Plus many of the functions can be controlled conveniently and easily via the multifunction steering wheel.





ELEGANCE

The ELEGANCE line displays its exclusivity with chrome trim strips all round, chrome-surround front fog lamps and a chrome-trimmed tailgate handle. The impressive front end features atlas grey radiator louvres with chrome edging, while the rear end positively shines with its polished stainless-steel tailpipe trim. The stylish appearance is completed by elegant 16-inch light-alloy wheels.

The exterior appearance corresponds harmoniously with the high-quality interior. The elegant myrtle wood trim highlights the exclusive standard of the line as does the combination of Bastogne fabric and ARTICO man-made leather. This is complemented to perfection by the high-quality leather trim on the steering wheel, handbrake lever and gearshift lever. There is also a highly useful addition in the form of the practical armrest with a stowage compartment between the front seats while the standard-fit Seat Comfort package comprises height adjustment for the front passenger seat as well as seat cushion adjustment and lumbar support for both front seats.





AVANTGARDE

The AVANTGARDE line is proud to display its sporty credentials and is clearly distinguishable by the more pronounced V-shape of the bumper fascia and the iridium silver radiator louvres. Bumpers painted in the vehicle colour are the perfect complement to the chrome strips all around the body, which provide stylish finishing touches. The front fog lamps also blend in harmoniously with the overall design. At the rear end, the oval exhaust tailpipe with polished stainless-steel trim draws the design to an impressive conclusion, while the 16-inch light-alloy wheels feature a powerful 5-spoke design to emphasise the dynamism of the AVANTGARDE line.

Inside, the diagonally brushed, smoke silver-coloured aluminium trim strips create a sporty atmosphere. This is complemented by the combination of Bastogne fabric and ARTICO man-made leather upholstery and by high-grade leather on the steering wheel, handbrake lever and gearshift lever. In the AVANTGARDE line, you can enjoy the benefits of the standard-fit Seat Comfort package. The additional height adjustment function for the front passenger seat together with seat cushion adjustment and lumbar supports for both front seats make even long journeys seem agreeably short.



Especially special

The Comfort package

Congratulations – if you're looking for that extra-special something, you've just found it: the Comfort package for the ELEGANCE and AVANTGARDE lines, brimming with first-class equipment features for truly comfort-oriented driving. Once inside, you are welcomed by high-grade leather

upholstery plus heated front seats. Attributes that will be appreciated on longer trips especially include the electrical adjustment (available for the saloon only) of the seat cushion height and angle as well as the backrest angle and fore/aft adjustment of the front seats.







Sports gear for your A-Class

The Sports package

Sport is good for the appearance. And there is no better proof of this than the optional Sports package for the A-Class. The instrument cluster with white dials stands out impressively against the silver-coloured backplate and is complemented by a shift or selector lever with leather and aluminium highlights. The sporty look and feel also extend to the easy-grip sports steering wheel with leather trim and the studded pedals in brushed stainless steel, not to mention the sports seats upholstered in ARTICO man-made leather and Zandvoort fabric.

On the outside, the oval stainless-steel exhaust tailpipe, the powerful 17-inch 7-spoke light-alloy wheels and the radiator grille louvres coloured metallic iridium silver with chrome strips are impressive additions. But as well as adding muscle on a visual level, the Sports package also makes for more dynamic, agile cornering thanks to the stiffer, lowered sports suspension.



It's good to let go once in a while. But better if you don't have to

Multifunction steering wheel and ISOFIX child seat attachment points

Your safety matters a great deal to us. This is why we have developed a steering wheel that enables you to keep your hands on the wheel. All the important information and functions you need when on the road are integrated. The multifunction steering wheel, fitted as standard, allows you to adjust the volume of the optional audio equipment and operate telephone functions, for example. Further controls let you call up information on the instrument cluster or change settings. Through all of this, your attention remains focused where it should be – on the road.

To maximise child safety, the A-Class has ISOFIX child seat attachment points fitted as standard on the outer seats in the rear. This standardised system makes it easier to fit child seats and hence reduces the risk of incorrect installation. Thanks to the rigid connection between the child seat and the vehicle body, ISOFIX minimises the risk of injury in the event of an accident. A further benefit in terms of child safety is the fact that the seat belt does not need to be tensioned first in the event of an emergency stop or an impact. The special design means that the seat decelerates along with the vehicle, so no valuable time is lost.



ISOFIX child seat attachment points in the rear with TopTether provide the best possible level of protection for your child, allowing a rigid connection between child seat and vehicle body



Longer than most wish lists: the standard equipment for the A-Class

From air conditioning to power windows and the multifunction steering wheel - thanks to the extensive range of standard equipment available for the A-Class, you barely need to lift a finger at all



The air conditioning creates a feeling of wellbeing on board



The adaptive brake lights issue a clear warning to the traffic behind if you have to stop in an emergency

STANDARD EQUIPMENT (SELECTION)

5-speed manual transmission¹ or 6-speed manual transmission²

Active front head restraints adjustable for height and angle, 3 rear head restraints adjustable for height and angle and retractable

Adaptive brake lights

Adaptive front airbags and head/thorax sidebags (backrest-mounted sidebags for additional head protection) for driver and front passenger

Air conditioning system

ASSYST service interval indicator

AUTOTRONIC³ (continuously variable automatic transmission)

Boot lighting and additional ambient and signal lights in the tailgate

Bottle holders in doors, cup holders in centre console

Brake Assist (BAS)

Clear-lens reflector-type headlamps

Electronic Stability Program ESP[®], incl. ABS and ASR

Headlamp Assist (automatic headlamp activation)

Heated exterior mirrors, electrically adjustable from inside the vehicle, with aspherically curved mirror glass

Heated rear window with time relay

Height-adjustable driver's seat

Height-adjustable steering column

Hill-Start Assist

ISOFIX child seat attachment points in rear with TopTether

Multifunction steering wheel and on-board computer with current fuel-consumption display

Power windows at the front (2) with one-touch up and down control

Rear seat 1/3: 2/3 split-folding, 2/3 section removable (not removable on coupé)

Rear windscreen wiper with intermittent wipe setting and one-touch control

Retractable luggage compartment cover

Speed-sensitive power steering and steering assistance system

Tinted windows all round

Two-tier load compartment floor, with underfloor stowage compartment (optional extra for coupé)

Tyre pressure loss warning system

Warning triangle, jack, TIREFIT with electric air pump

¹ Standard equipment for A 160 BlueEFFICIENCY, A 180 BlueEFFICIENCY, A 200 and A 160 CDI BlueEFFICIENCY

² Standard equipment for A 180 CDI, A 200 CDI and A 200 TURBO

³ Standard equipment for A 160 CDI, A 160 and A 180



The A-Class is a willing helper. Especially when you need to park

Active Parking Assist. With integrated PARKTRONIC

It's good to let someone else do the work. Like when the Active Parking Assist system intervenes. It complements the proven PARKTRONIC system since, as well as telling you how much space there is behind or in front of the car, it has ultrasonic sensors that detect whether your car will fit into a parking space as you are driving past it. As soon as you then engage reverse gear and confirm your wish to park, all you need to do is dab the accelerator and brake. The system turns the steering wheel automatically, parking the car parallel to the direction of travel in just a few moves. Needless to say, you remain in control throughout the entire process.



The distance sensors in the front and rear bumper monitor the parking process



The display in the instrument cluster gives you a clear picture of what is happening at all times

Sounds good

Audio and communication systems

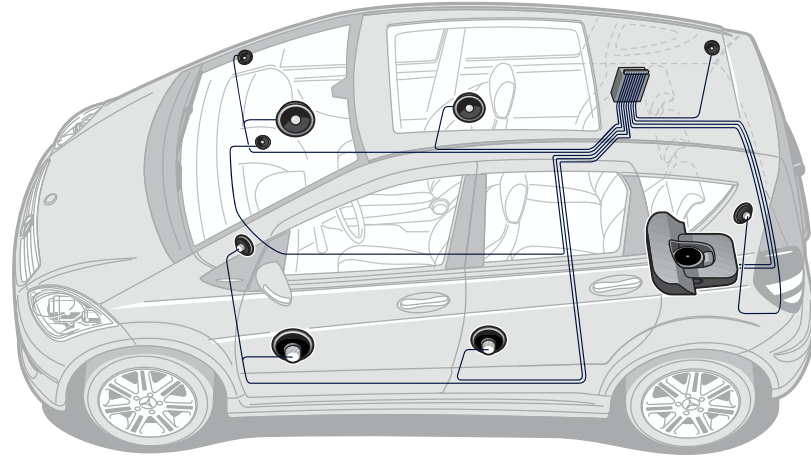

Good entertainment requires top-grade equipment. In the A-Class, the highlight in this respect is the COMAND APS multimedia system. Its improved control structure and functions make it even easier than before to operate the hard-disc navigation system (APS) or the audio and video functions of the DVD player. All the important messages and information appear on the large (6.5-inch) colour display. Both COMAND APS and Audio 50 APS feature a radio and a DVD drive. The voice-operated control system LINGUATRONIC offers useful functions and further enhanced ease of operation

for the user (standard in conjunction with COMAND APS and Audio 50 APS with a DVD changer). The audio systems have also received a major upgrade and now all include an integral CD player, MP3/WMA function and an Aux-in socket in the glove compartment (plus an optional media interface). And phoning is made easy courtesy of the mobile phone pre-installation with a Bluetooth® interface (from Audio 20 CD upwards). The audio systems from Audio 20 CD upwards (with an integral CD changer) can be combined with the optional Harman Kardon®

Logic 7® surround sound system. The ten high-performance loudspeakers in the coupé (or twelve in the saloon) are optimised for the special characteristics of the car and deliver extremely impressive acoustic performance. Together with a subwoofer and the 450-watt DSP amplifier, they provide superb surround-sound reproduction of stereo and “Dolby 5.1*” recordings.

*Only in conjunction with COMAND APS



Open up to the world

The panoramic louvred sunroof and panoramic roof

A ray of sunlight travels around 100 million miles before reaching our planet. So it deserves a fitting welcome. Luckily the optional panoramic louvred sunroof for the A-Class is on hand. A touch of a button is all it takes to bring heaven a little closer and make you forget about the everyday routine. Firstly, the foremost louvre of the panoramic louvred sunroof rotates into the ventilation position. Then the roof opens as much as you want it to - which is much further than most conventional sunroofs. But even when closed, the scratch-resistant, transparent surface allows light to flood into the interior. What's more, if you have had enough light for one day, the manually

operated twin roller blind system comes into play. It protects you from the sun when closed and

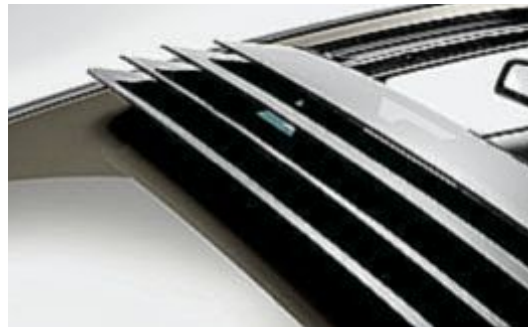

The panoramic louvred sunroof is your gateway to the sky

acts as a wind deflector when open. A panoramic roof is also available as an optional extra.



The panoramic roof makes for plenty of light



Special requests are our speciality

Optional extras



Audio 50 APS for the best in entertainment and navigation



THERMOTRONIC for a perfect travelling climate



Multicontour seat for optimum long-distance comfort



Bi-xenon headlamps/cornering light function for optimum visibility

Choose from a wide range of equipment options and transform the A-Class into your own personal dream car. Opt for the Audio 50 APS car radio with an integral DVD player for MP3/WMA playback, DVD navigation system and Bluetooth® interface, for example. Meanwhile an ideal climate is maintained by the luxury automatic climate control THERMOTRONIC which allows the temperature on the driver's side and front-passenger side to be controlled separately. Then there is the multicontour seat: as well as offering optimal support for those who like to drive dynamically, it adjusts perfectly to the occupant's anatomy or individual comfort requirements thanks to its adaptive air chambers. Finally bi-xenon headlamps with a special cornering light function maximise safety and optimise visibility.

OPTIONAL EXTRAS (SELECTION)

Active Parking Assist, incl. PARKTRONIC function

Audio 50 APS: DVD arrow-based navigation with map display in junction area, Bluetooth® interface, DVD player with MP3 and WMA support

AUTOTRONIC transmission incl. cruise control with SPEEDTRONIC

Bi-xenon headlamps with headlamp cleaning system and cornering light function

Child seat recognition in front passenger seat (automatic) for child seats with a transponder and specifically approved by Mercedes-Benz

COMAND APS multimedia system: with hard-disc map navigation, DVD video, MUSIC REGISTER, LINGUATRONIC, SD memory card reader, Bluetooth® interface, Dolby 5.1

Comfort package for ELEGANCE and AVANTGARDE (leather appointments, electrically adjustable and heated front seats)¹

Convenience Telephony for a range of mobile-phone cradles in centre console/armrest, incl. hands-free system, operation via multifunction steering wheel, aerial amplifier and GSM wiring

Cruise control with SPEEDTRONIC

EASY-VARIO system for coupé: adjustable two-tier load compartment floor and removable rear seat cushions (1/3 and 2/3 sections)

EASY-VARIO-PLUS system for saloon: removable rear seat cushion (1/3 section) and backrests (1/3 and 2/3 sections), removable front passenger seat with forward-folding backrest

Electrically folding exterior mirrors left and right

Front sports seats (in conjunction with Sports package)

Harman Kardon® Logic 7® surround sound system

Heated front seats

Light and Sight package: interior mirror with automatic dimming function, rain sensor, headlamp switch-off delay, locator lighting, reading light for driver, reading light in rear, illuminated vanity mirror, footwell lights

Loudspeaker system with central speaker and woofer

Panoramic louvred sunroof

Panoramic sunroof

Rear power windows, one-touch up/down control

Seat Comfort package: height-adjustable front passenger seat, front seats with seat cushion adjustment and lumbar support (standard for ELEGANCE and AVANTGARDE lines)

Sidebags in rear

Sports suspension

THERMOTRONIC luxury automatic climate control

Windowbags

¹ Only seat heating is available in the coupé

Highlights from the bottom up

Light-alloy wheels

The standard version of the A-Class features 15-inch 7-hole wheel trims. But there is also a wide range of light-alloy wheels available, depending on the engine size and the design and equipment line. The ELEGANCE and AVANTGARDE lines have 16-inch light-alloy wheels fitted ex factory. In tune with specific

requirements, they feature either a stylish 10-twin-spoke design (ELEGANCE line) or a distinctly sporty 5-spoke design (AVANTGARDE line). All lines also have the option of 16-inch 7-spoke light-alloy wheels or 17-inch 6-spoke light-alloy wheels. The optional Sports package includes unique 17-inch 7-spoke wheels. And,

to make the A-Class really shine, customers can order optional 18-inch AMG 5-spoke light-alloy wheels in titanium silver.



15-inch steel wheel with wheel trim in 7-hole design (standard equipment)



16-inch 10-twin-spoke light-alloy wheel (ELEGANCE)



16-inch 5-spoke light-alloy wheel (AVANTGARDE)



16-inch 7-spoke light-alloy wheel (optional)



17-inch 6-spoke light-alloy wheel (optional)



17-inch 7-spoke light-alloy wheel (Sports package)



18-inch 5-spoke light-alloy wheel (AMG)



Incenio "Anshan" 16-inch 10-spoke designer wheel



Incenio "Asaramas" 17-inch 5-spoke designer wheel



Send your senses on a voyage of discovery

designo

When it comes to questions of taste, designo appointments have the perfect answer. With materials that make every touch a caress. And design elements that hold your gaze. For the seats, the design specialists at designo have created four high-grade leather/Alcantara® combinations. Additional touches are provided by poplar wood trim in designo

anthracite in combination with high-quality piano lacquer and the designo wood/leather gearshift lever. The interior appointments are rounded off by the front armrest upholstered in black designo leather and the high-grade velour floor mats trimmed in black designo leather. Further details can be found in our designo brochure.



What goes best with a Mercedes-Benz?

Genuine accessories

Even though there is nothing really to be added to enhance the vehicle concept of the A-Class, the extensive accessories range from Mercedes-Benz can provide you with a raft of further ideas to help you tailor your A-Class to your own requirements even more precisely. Take, for example, the handy “New Alustyle” ski and snowboard rack. Or the Mercedes-Benz roof box M, which is made

of high-grade, durable materials, has a capacity of approx. 400 litres and yet still helps to keep your fuel consumption down due to its sophisticated aerodynamics. Equally practical and easy to use: the rear-mounted cycle rack, specially developed for the A-Class. Or the media interface consumer cable which makes it easy for you to play music files in a number of common formats

via the audio system. In conjunction with the optional media interface in the glove compartment, this cable set makes it easy to hook up iPod® units or other devices with a USB or Aux-in port. For even more useful accessories, please see our separate accessories brochure. Or ask your Mercedes-Benz dealer, who will be only too glad to help you.





The A-Class paintwork puts the finishing touch to the carefully crafted Mercedes-Benz corrosion protection system for the body, which includes zinc phosphating and electrophoretic dip priming stages for long-lasting protection. Furthermore, we only use eco-friendly water-based paints.

NON-METALLIC PAINTS¹



589 jupiter red



650 cirrus white

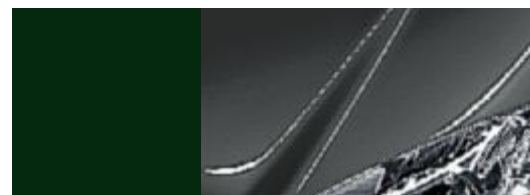

696 night black

¹ Standard equipment. Not available for the ELEGANCE and AVANTGARDE lines

² Optional extra

METALLIC PAINTS²

191 cosmos black



478 delta green



761 polar silver



240 lotus blue



490 steppe brown



787 mountain grey



391 horizon blue



597 saturn red

FABRIC STANDARD EQUIPMENT



311 black "Mechelen"



315 orient beige "Mechelen"

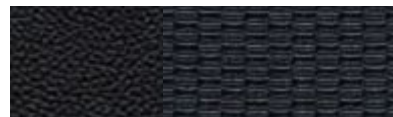
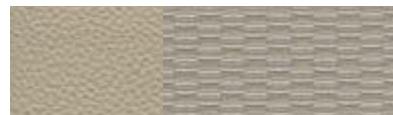

611 black/multicolour "Namur"

LEATHER/FABRIC SPORTS SEATS¹751 black
ARTICO³/"Zandvoort" fabricLEATHER/FABRIC ELEGANCE⁵411 black
ARTICO³/"Bastogne" fabric415 orient beige
ARTICO³/"Bastogne" fabric418 alpaca grey
ARTICO³/"Bastogne" fabricLEATHER/FABRIC AVANTGARDE⁶721 black
ARTICO³/"Bastogne" fabric725 orient beige
ARTICO³/"Bastogne" fabric728 alpaca grey
ARTICO³/"Bastogne" fabric¹ Part of the optional Sports package² Optional extra, only in conjunction with Comfort package³ Man-made leather⁴ Standard equipment⁵ Standard equipment for the ELEGANCE line⁶ Standard equipment for the AVANTGARDE line⁷ Included with designo leather / Alcantara[®] upholstery

LEATHER ELEGANCE²



801 black



805 orient beige



808 alpaca grey

LEATHER AVANTGARDE²



801 black



805 orient beige



808 alpaca grey

TRIM PARTS



Plastic in high-gloss black⁴

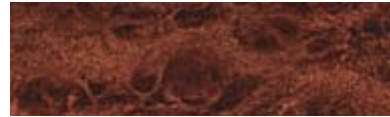

Myrtle wood⁵



Aluminium in smoke silver, diagonally brushed⁶

designo²



designo anthracite poplar
designo trim part⁷



X20 designo black
designo leather / Alcantara[®] upholstery



X90 designo alpaca grey
designo leather / Alcantara[®] upholstery



X91 designo java
designo leather / Alcantara[®] upholstery



X93 designo imperial red
designo leather / Alcantara[®] upholstery

Colours and materials

	NON-METALLIC PAINTS			METALLIC PAINTS							
	jupiter red	cirrus white	night black	cosmos black	lotus blue	horizon blue	delta green	steppe brown	saturn red	polar silver	mountain grey
FABRIC STANDARD APPOINTMENTS											
black "Mechelen"	●	●	●	●	●	●	●	●	●	●	●
orient beige "Mechelen"	○	○	●	●	△	△	●	●	●	△	△
black/multicolour "Namur"	●	●	●	●	●	○	●	●	●	●	●
LEATHER/FABRIC SPORTS SEATS											
black, ARTICO man-made leather/"Zandvoort" fabric	●	●	●	●	●	●	●	●	●	●	●
LEATHER/FABRIC ELEGANCE AND AVANTGARDE											
black, ARTICO man-made leather/"Bastogne" fabric	●	●	●	●	●	●	●	●	●	●	●
orient beige, ARTICO man-made leather/"Bastogne" fabric	○	○	●	●	△	△	●	●	●	△	△
alpaca grey, ARTICO man-made leather/"Bastogne" fabric	●	●	●	●	●	○	○	△	●	●	●
LEATHER ELEGANCE AND AVANTGARDE											
black	●	●	●	●	●	●	●	●	●	●	●
orient beige	○	○	●	●	△	△	●	●	●	△	△
alpaca grey	●	●	●	●	●	○	○	△	●	●	●
designo LEATHER/ALCANTARA® APPOINTMENTS											
designo black	●	●	●	●	●	●	●	●	●	●	●
designo alpaca grey	○	○	●	●	●	△	●	○	●	●	●
designo java	△	○	●	●	○	△	●	●	●	△	△
designo imperial red	○	●	●	●	△	○	△	△	●	●	●

● Recommended

○ Possible

△ Not recommended

Coupé

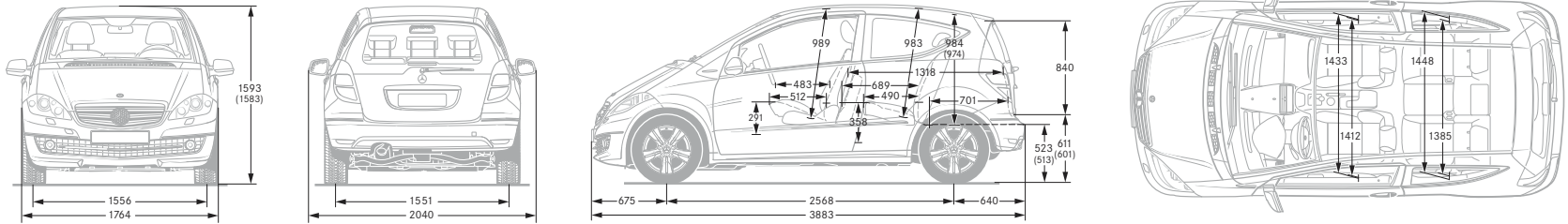

Saloon

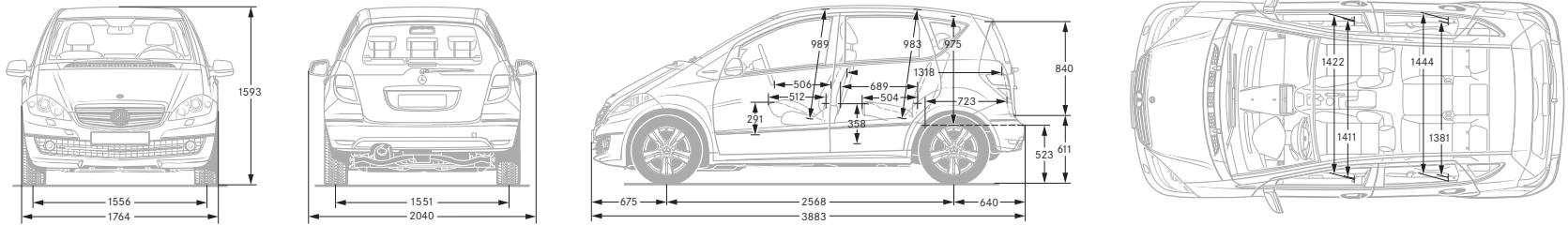

Figures in brackets apply to the A 160 CDI Coupé with manual transmission and sports suspension. All measurements in millimetres. The dimensions shown are mean values and apply to standard-specification, unladen vehicles

Technical data

	A 160 CDI BlueEFFICIENCY	A 160 CDI	A 180 CDI	A 200 CDI
No. of cylinders/arrangement	4/in-line	4/in-line	4/in-line	4/in-line
Total displacement (cc)	1991	1991	1991	1991
Rated output ¹ (kW at rpm)	60/4200	60/4200	80/4200	103/4200
Rated torque ¹ (Nm at rpm)	180/180 ⁴ /1400-2600	200/1400-2600	250/1600-2600	300 (280)/1600-3000
Compression ratio	18.0	18.0	18.0	18.0
Acceleration (0-100 km/h in s)	15.0	15.3	10.8 (11.1)	9.5 (9.6)
Top speed, approx. (km/h)	170	165	186 (181)	201 (196)
Tyre size	185/65 R 15	185/65 R 15	185/65 R 15	195/55 R 16
Fuel	Diesel	Diesel	Diesel	Diesel
Fuel consumption ² (l/100 km)				
urban (automatic transmission)	5.4-5.8/5.3-5.5 ⁴	(7.0-7.6)	6.4-6.5 (7.0-7.6)	6.5-6.6 (7.1-7.9)
extra-urban (automatic transmission)	3.9-4.1/3.8-4.0 ⁴	(4.4-4.9)	4.2-4.4 (4.4-4.9)	4.3-4.4 (4.9-5.0)
combined (automatic transmission)	4.5-4.7/4.4-4.5 ⁴	(5.4-5.8)	5.0-5.2 (5.4-5.8)	5.1-5.3 (5.7-6.0)
CO ₂ emissions ² (g/km) combined (automatic transmission)	118-125/116-119 ⁴	(142-154)	134-138 (142-154)	135-139 (149-159)
Tank capacity (l)/incl. approx. reserve	54/6	54/6	54/6	54/6
Kerb weight ³ (kg)	1325/1280 ⁴	1370/1345 ⁴	1345/1320 ⁴	1365/1340 ⁴
Perm. GVW (kg)	1835	1835	1830	1880

Figures in brackets apply to vehicles with automatic transmission

¹ Figures in accordance with Directive 80/1269/EEC in the currently applicable version

²The figures shown were obtained in accordance with the prescribed measuring process (Directive 80/1268/EEC in the currently applicable version). The figures are not based on an individual model and do not constitute part of the product offer; they are provided solely for purposes of comparison between different vehicle models

A 160 BlueEFFICIENCY	A 160	A 180 BlueEFFICIENCY	A 180	A 200	A 200 TURBO
4/in-line	4/in-line	4/in-line	4/in-line	4/in-line	4/in-line
1498	1498	1699	1699	2034	2034
70/5200	70/5200	85/5500	85/5500	100/5500	142/5000
140/3500-4000	140/3500-4000	155/3500-4000	155/3500-4000	185/3500-4000	280/1800-4850
11.0	11.0	11.0	11.0	11.0	9.0
12.6	13.5	10.9	11.5	9.8 (9.9)	7.5 (7.3)
175	170	188	183	200 (195)	228 (220)
185/65 R 15	185/65 R 15	185/65 R 15	185/65 R 15	195/55 R 16	195/55 R 16
Premium petrol	Premium petrol	Premium petrol	Premium petrol	Premium petrol	Super Plus
7.5-7.8	(8.5-8.7)	8.1-8.2	(8.6-9.0)	8.7-8.9 (9.6)	10.1-10.3 (10.2-10.3)
5.1-5.2	(5.5-6.0)	5.2-5.7	(5.5-6.0)	5.6 (5.9-6.1)	6.0 (6.5-6.6)
6.0-6.2	(6.6-7.0)	6.3-6.6	(6.6-7.1)	6.7-6.8 (7.2-7.4)	7.5-7.7 (7.9-8.1)
139-143 ⁵	(157-166)	145-153 ⁵	(157-169)	156-159 (172-176) ⁵	178-182 (187-192)
54/6	54/6	54/6	54/6	54/6	54/6
1245/1215 ⁴	1275/1245 ⁴	1260/1230 ⁴	1279/1260 ⁴	1270/1240 ⁴	1305/1275 ⁴
1740	1740	1770	1770	1765	1835

³ Figures according to Directive 92/21/EC, version 95/48/EC (kerb weight with fuel tank 90 % full, driver, 68 kg, and luggage, 7 kg) for standard-specification vehicles. Optional extras and accessories will generally increase this figure and reduce the payload capacity accordingly ⁴ Figures refer to coupé ⁵ Complies with EU 5 emissions standard; in the case of the A 200, only the manual transmission version complies



Anyone opting for a Mercedes buys far more than just a car

Mercedes-Benz mobility. Your car comes with the assurance of carefree driving, but if you should ever need help Mercedes-Benz Service24h is there for you. Just call the freephone service hotline on 00800 1 777 7777¹. The newly integrated telematics service Mercedes-Benz Contact² is even more customer-friendly: a touch of a button is all it takes to contact the Mercedes-Benz customer centre. If you wish, the relevant vehicle and position-related data can be transmitted at the same time, ensuring the shortest possible reaction time and rapid aid. Also standard with your new car at no extra charge is the Mercedes-Benz Mobilo³ mobility package. Whether you have lost your key, have had a breakdown which cannot be repaired immediately or if the vehicle is damaged due to an accident or vandalism, Mobilo ensures that you still reach your destination – anywhere in Europe. Whatever your problem, one thing is certain: you will soon be able to resume your journey.

MercedesCard. Your ticket to the Mercedes-Benz experience: the quarterly MercedesCard Journal ARGENTUM offers you an exclusive selection of exciting events starring the Mercedes-Benz brand. In addition to this, the Mercedes Magazine is packed with gripping and inspiring articles and reports. The MercedesCard has many other functions: as a VISA credit card, it is an accepted form of payment worldwide – with no annual fee if you complete a questionnaire every year. In addition, it offers further benefits to put your mind at ease, such as the Mercedes-Benz insurance package, at no extra charge, and the specially designed MercedesCard insurance package at a preferential rate. For further information about this offer, available exclusively to Mercedes-Benz drivers, visit www.mercedes-benz.de/mercedescard⁴

Mercedes-Benz Bank. If you have already chosen your dream car and want to remain financially flexible, the Mercedes-Benz Bank should be your next port of call. It is your one-stop shop for leasing, financing, insurance and service packages. By way of example, our “Private Leasing Plus” scheme is a complete package comprising leasing, third-party insurance and fully-comprehensive insurance as well as a purchase option. Meanwhile, our “Plus3” financing combines the low repayment rates of a financing scheme with the flexibility of leasing. You then have three options at the end of the contract: you can keep the car, sell it or return it to us for a guaranteed price and switch to a new model. In addition to this, we can offer you a range of investment products such as instant-access savings accounts, fixed-interest products and investment funds. For further information, please call us on 01803/32 22 65⁵ or visit us at www.mercedes-benz-bank.de

¹ Charges for calls made from mobile phones may vary, depending on service provider

² Requires factory-fitted radio and a switched-on mobile phone. The only charge incurred is the cost of the mobile phone call to the landline network

³ When the warranty has expired Mobilo can be extended by another year for a maximum of 30 years, provided that regular maintenance is carried out by your Mercedes-Benz service partner

⁴ Information about the MercedesCard in Austria and Switzerland can be found on the Mercedes-Benz websites for these countries

⁵ 9 ct./min. from Deutsche Telekom landlines, mobile-phone rates may vary



Time for another enriching experience

A Mercedes-Benz is most at home on the road. This is the only way to experience the effortlessly superior driving feel that lends every model its inimitable class. Feel the power of the engine as it propels the car forwards. Marvel at the precise steering, designed to really put you in the mood for driving. And experience what true comfort really feels like. The unique feeling of driving a Mercedes cannot be put into words, however. Which is why we'd like to invite you to take a test drive. Your Mercedes-Benz dealer will be happy to make all the necessary arrangements for you. Simply visit www.mercedes-benz.com to locate the nearest Mercedes-Benz dealer in your country or region. We look forward to seeing you.

The website also offers an interactive tour, enabling you to take a closer look at your desired model. This simulation is the ideal way to acquaint yourself with your dream car. You can view key functions in detail, gain an insight into the car's inner workings or look at the benefits of each model. For further information, visit www.mercedes-benz.de/owners-manual

Now your mobile phone acts as a gateway to the whole Mercedes-Benz world. In addition to an overview of all passenger car models, there are insights into the entire brand world, not to mention a wealth of entertainment offers and direct links to a range of services at www.mercedes.mobi

Take-back of end-of-life vehicles. Coming full circle. At the end of its long life, you can return your A-Class to us for environment-friendly disposal in accordance with the EC End-Of-Life Vehicle Directive¹. But that day lies a long way off.

¹ Applies in accordance with national regulations to vehicles up to 3.5 tonnes gross weight. Mercedes-Benz passenger cars have met the statutory regulations governing the suitability of their design for reuse and recycling for a number of years now. A network of vehicle take-back depots and dismantlers has been established which will process your vehicle in an environment-friendly manner. The ways in which both vehicles and parts can be recovered are subject to ongoing development and improvement. Consequently, the A-Class will be able to comply with any future increases in the recycling quota within the stipulated time limits. For further information, please call 00800 1 777 7777.

Please note: changes may have been made to the product since this brochure went to press (09.02.2009). The manufacturer reserves the right to make changes to the design, form, colour and specification during the delivery period, provided these changes, while taking into account the interests of the vendor, can be deemed reasonable with respect to the purchaser. Where the vendor or the manufacturer uses symbols or numbers to describe an order or the subject of an order, no rights may be derived solely from these. The illustrations may show accessories and items of optional equipment which are not part of standard specification. Colours may differ slightly from those shown in the brochure, owing to the limitations of the printing process. This brochure has been compiled by Daimler AG of Germany and is distributed internationally. It provides a general indication of the range of models, features, optional extras and/or colours available in various countries. Some of the models, features, optional extras and/or colours shown may not be available in your country or may only be available in a different specification. Additionally some models, features, optional extras and/or colours may only be available in combination with others. For current and more specific information in relation to the range of models, features, optional extras and/or colours available in your country, and their pricing, you should contact your nearest authorised Mercedes-Benz Passenger Car Dealer. www.mercedes-benz.com