



The 2010 SL-Class

Mercedes-Benz

SL: two letters that spell “legend.”

The Mille Miglia is Italy’s most famous road race. It takes three days to complete and covers a full 1,600 kilometres from Brescia to Rome and back. The roads run through everything from sleepy little villages to the most impressive piazzas. This is where the SL-Class’ most distinguished ancestor made history back in 1955.

That was the year the standard-production Mercedes-Benz 300 SL roadster left all the favourite models in the Italian GT class in its wake, stunning observers and claiming its place among the most famous production racers of all time.

The 2010 SL-Class roadster revisits these legendary racing roots with impressive engines and chassis that are truly worthy of the SL name. Better yet, we’ve combined this raw aggression with a stunning design and all the fit and finish you expect from a Mercedes-Benz, making the SL-Class a roadster unlike any you’ve ever experienced before.







The SL-Class

DESIGN	
Exterior	4
Retractable hardtop	6
Interior	8
Entertainment and Communication	10
<hr/>	
AGILITY	
Engines	12
Transmissions	14
Handling	16
<hr/>	
SAFETY	18
<hr/>	
PERFORMANCE	
AMG	22
<hr/>	
COLOURS AND MATERIALS	
Paint, combination options	26
Upholstery and trim	28
<i>designo</i>	30
<hr/>	
EQUIPMENT	
Wheels	32
Equipment listing	34
<hr/>	
ACCESSORIES	36
<hr/>	
TECHNICAL FEATURES	
Technical data	37
<hr/>	
MERCEDES-BENZ OWNERSHIP	38
<hr/>	
MERCEDES-BENZ WEBSITE	39
<hr/>	
TEST DRIVE	40
<hr/>	

The sporting meets the sublime.

A low seating position and a sense of the sublime are waiting for you aboard the 2010 SL-Class.

Your eyes dance along the roadster's elongated nose, whose power domes hint at the powerful engine that lies within. The power plant responds smoothly as you gently press the accelerator and the car eats up kilometre after kilometre of road.

But it goes way beyond performance. Design elements, like the impressive side gills, add visual excitement as well. Exclusive paint finishes, attractive wheels and performance tires add to this effect, as does the AMG Styling Package, which is standard on all models. Its sharply contoured front and rear aprons and side sills add final touches that are to die for.

When it comes to a total driving experience, the SL-Class is the complete package.

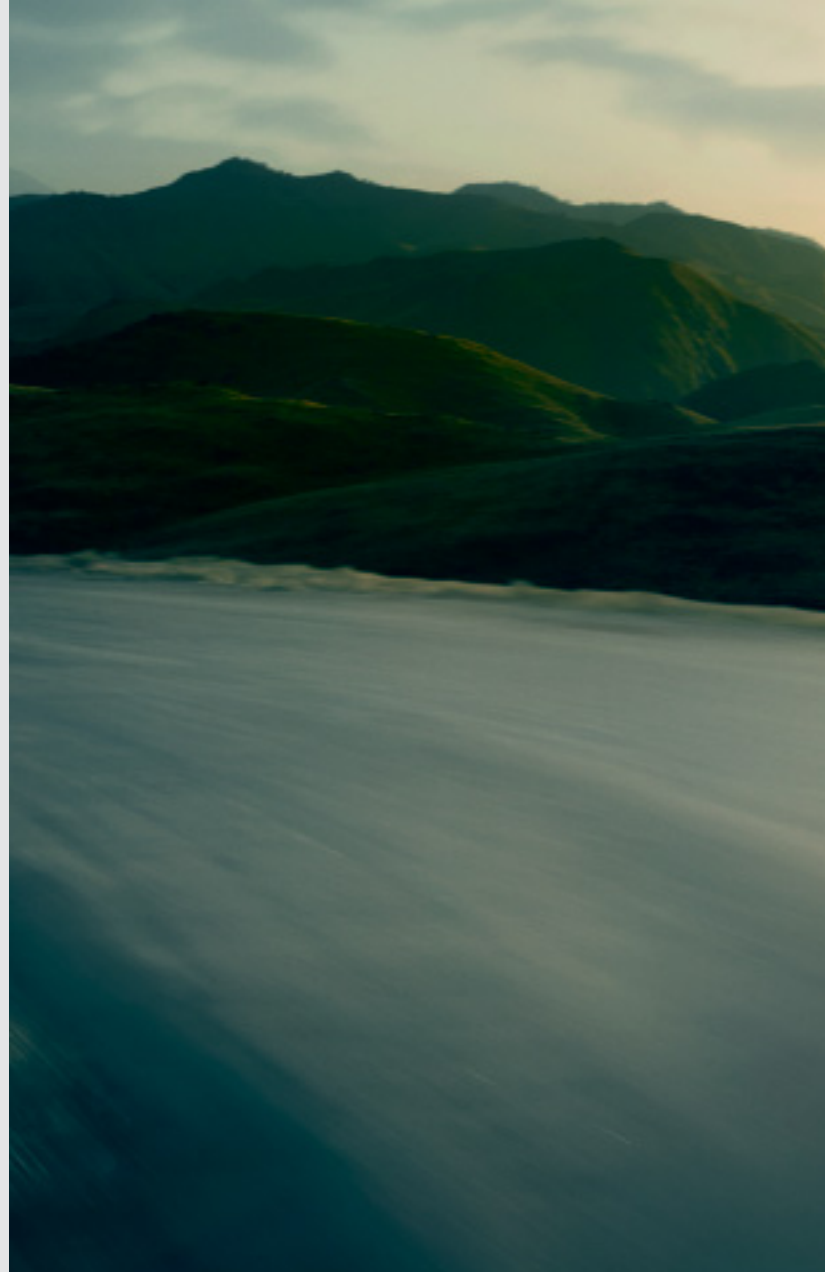



Magnify the sky.

Make that sunset last a little longer. The innovative hardtop retractable roof gives you the security of a coupe and the freedom of an open-air roadster. Touch the button on the console or on your SmartKey remote and the SL-Class' top disappears in 16 seconds – faster than any other retractable hardtop in production. Even with the hardtop retracted into the rear, the SL550 has enough trunk space to carry two golf bags.

If that's not enough, experience the open sky in any weather with the panoramic vario-roof¹. A tinted glass section replaces the conventional metal roof deck above the driver and passenger, allowing you to magnify the sky. On hot days, shade yourself from the sun with an extendable screen.

Meet the innovative AIRSCARF system¹. At the touch of a button, fans at the rear of the head restraints suck in air that is then heated and expelled through the front of the seat. The warm air wraps itself round your head and neck, prolonging the open-top driving season. Three settings let you select the perfect temperature.



¹Only available as part of the Premium Package on the SL550 and SL63 AMG. Standard on the SL600 and SL65 AMG.

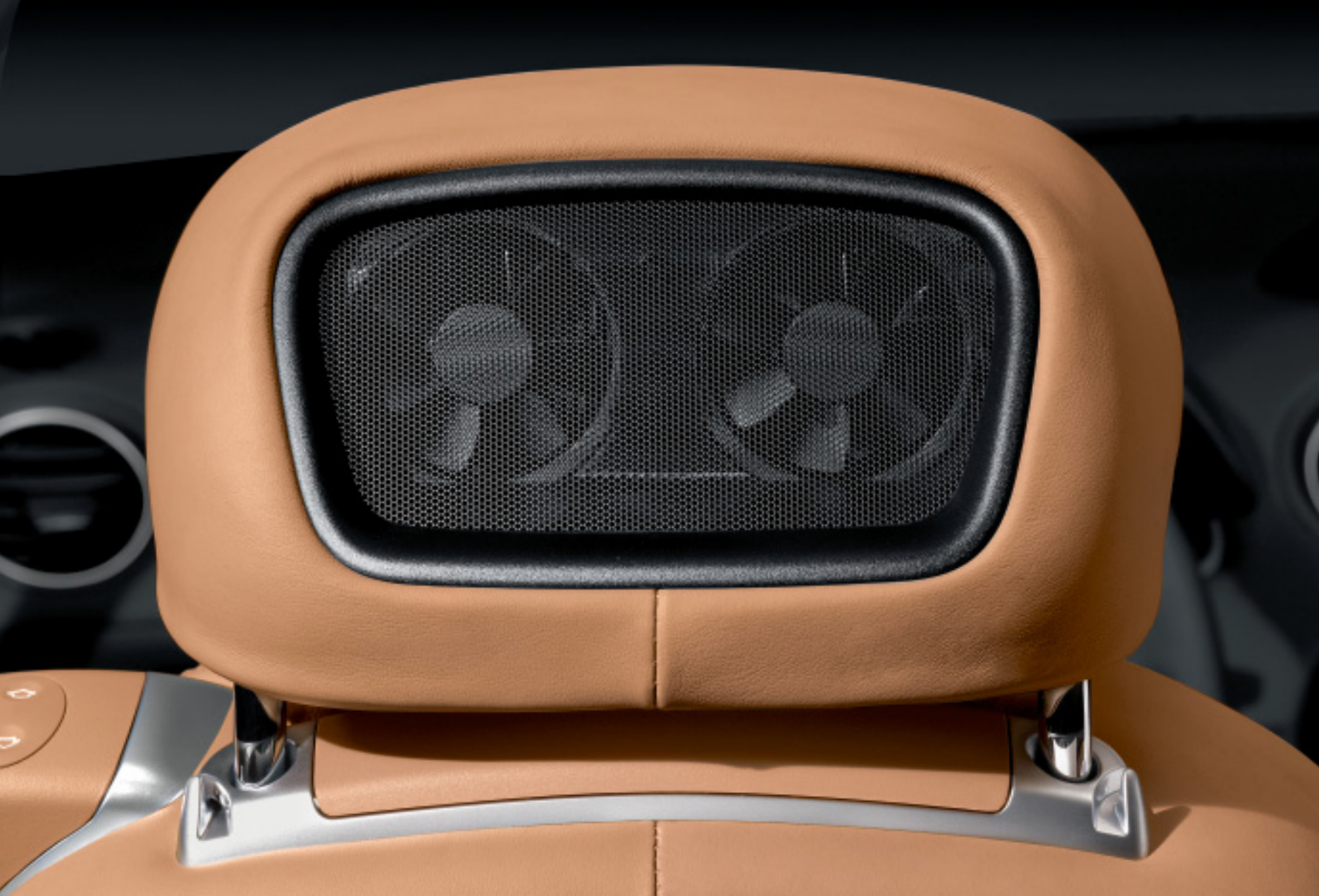





Some comforting thoughts.

Surround yourself in opulent Burl Walnut¹, Dark Ash² or Poplar³ wood trim, or opt for sleek AMG Carbon Fibre⁴ on the AMG models. Splendor in luxurious leather upholsteries, available in a variety of rich colour combinations. The leather trim for the instrument cluster is a highly complementary detail, and the celebrated 3-spoke steering wheel trimmed in supple leather and high-gloss Burl Walnut is a magnificent addition.

Multicontour leather seats are also standard. They allow you to adjust your seat to the unique contours of your body. Air cushions in the lumbar and side bolsters provide lateral support when cornering. With the push of a button, air pads gently pulsate to massage your back muscles. The Climate Comfort seats⁵ feature heat at the touch of a button, as well as active ventilation for cooling down.

Enjoy perfect climatic comfort with THERMOTRONIC automatic climate control, standard in all SL-Class models. Automatic adjustments are made for individual occupants based on sunlight intensity and moisture. Plus, a sophisticated air filter for dust and pollutants keeps the air ultra-clean.

When it comes to comfort, the SL-Class leaves nothing to be desired.

¹Standard on the SL550 and SL600. Available as a stand alone option on the SL63 AMG and SL65 AMG and includes matching wood and leather steering wheel. ²Available as a stand alone option on all models. Includes matching wood and leather steering wheel on the SL63 AMG and SL65 AMG. ³Available as a stand alone option on the SL600 and SL65 AMG. Not available on the SL550 or SL63 AMG. ⁴Not available on the SL550 or SL600. ⁵Only available as part of the Premium Package on the SL550 and SL63 AMG. Standard on the SL600 and SL65 AMG.

High technology equals high simplicity.

The cockpit of the SL-Class is designed with ergonomics in mind, and features perfectly positioned controls and displays.

Experience radio like never before with standard SIRIUS Satellite Radio¹, featuring 120 channels, including 100% commercial-free music from every genre, plus sports, news, talk and comedy – all with crystal-clear, coast-to-coast coverage. Also standard is the harman/kardon[®] LOGIC7[®] surround sound system, with high performance speakers and Digital Signal Processors (DSP) for optimal acoustics within the interior of a roadster. It even adjusts itself when the top goes down.

The SL's Media Interface offers full integration with the harman/kardon[®] surround sound system. It features three connection options via USB, iPod[®] or auxiliary audio input, and allows you to control your iPod[®] playlists with the multifunction steering wheel buttons or the COMAND APS system.

Speaking of the COMAND APS control and display system, it combines navigation, Bluetooth connectivity, audio and telephone into one elegant 6.5" high-resolution full colour screen. Its interface has extended functionality but is more intelligent and user-friendly than ever before, with no need to change navigation DVDs thanks to an internal hard drive storage system. Easier still, all key functions can now be called up by means of the LINGUATRONIC voice control function that recognizes street and city names without the need for voice training or spelling. The SD memory card slot and MUSIC REGISTER function that provides up to 4GB of storage space on the internal hard drive further improve MP3 capabilities.





10:28

TA

Navi Audio Tel Video System

2. SWR1 BW

3. SWR4 S

1. SWR3

4. SWR2 BW

7. 90.8 MHz

Radio Speicher FM Klang

Which flavour of outstanding performance would you prefer?

Mercedes-Benz has been making racing history with the SL-Class since the legendary Gullwing model of 1954. But it has never been quite as dynamic as it is today, equipped with eight and twelve cylinder engines that deliver spine-tingling acceleration.

The SL-Class experience starts with a V-8 engine under the hood of the SL550. Its 382 hp catapult it to 100 km/h in a mere 5.4 seconds, and 391 lb-ft of torque is available between 2,800 and 4,800 rpm.

V-12 engines have always been synonymous with supreme confidence and reassurance in any situation on the road. The SL600 stays true to this tradition with performance that will take your breath away. With a blistering 510 hp and 612 lb-ft of maximum torque, the SL600 sears 0 to 100 km/h in 4.5 seconds. Twin intercooled turbochargers offer instantaneous response and torque delivery at extremely low revs.

Whichever model you choose, performance will never be an issue. With the 2010 SL-Class, it's merely a matter of degrees.





Skip straight to the fun.

7G-TRONIC, the world's first 7-speed automatic transmission makes shifting virtually imperceptible to the driver and passenger. It also delivers improved power and acceleration, while enhancing fuel efficiency.

Two different shift modes are selected via the console shifter: Comfort and Sport. In Comfort mode, the transmission shifts up sooner and the suspension adopts a more comfortable setting. Sport mode offers a more dynamic suspension setting with up shifts occurring at a higher rpm.

Our 7G-TRONIC 7-speed automatic transmission comes standard on the SL550, while the SL600 and SL65 AMG feature highly advanced 5-speed automatic transmissions. The SL550 and SL600 now also come standard with the Sport Package, which allows manual gear changes with two shift paddles mounted conveniently to the stylish sport steering wheel. This package also includes upgraded front calipers and perforated brake rotors giving you even more control over the road.

Taking performance a step further, the SL65 AMG features AMG-enhanced capabilities and standard manual shift paddles. AMG SPEEDSHIFT programming makes gear changes up to 35% faster, with automatic downshifts during braking and one-touch selection for optimal acceleration.

The SL63 AMG is the first AMG sports car to feature the innovative AMG SPEEDSHIFT MCT 7-speed sports transmission. MCT stands for "Multi-Clutch Technology". It provides unrivalled performance and offers a unique combination of sportiness, responsiveness and smoothness. Thanks to its wet start-off clutch, in place of a traditional torque converter, this technological marvel offers instant, uninterrupted power transmission at all times under all conditions. Shift times are 20% faster than our already lightning-fast AMG SPEEDSHIFT 7G-TRONIC unit, and the automatic double-declutching and race start functions ensure optimal performance.

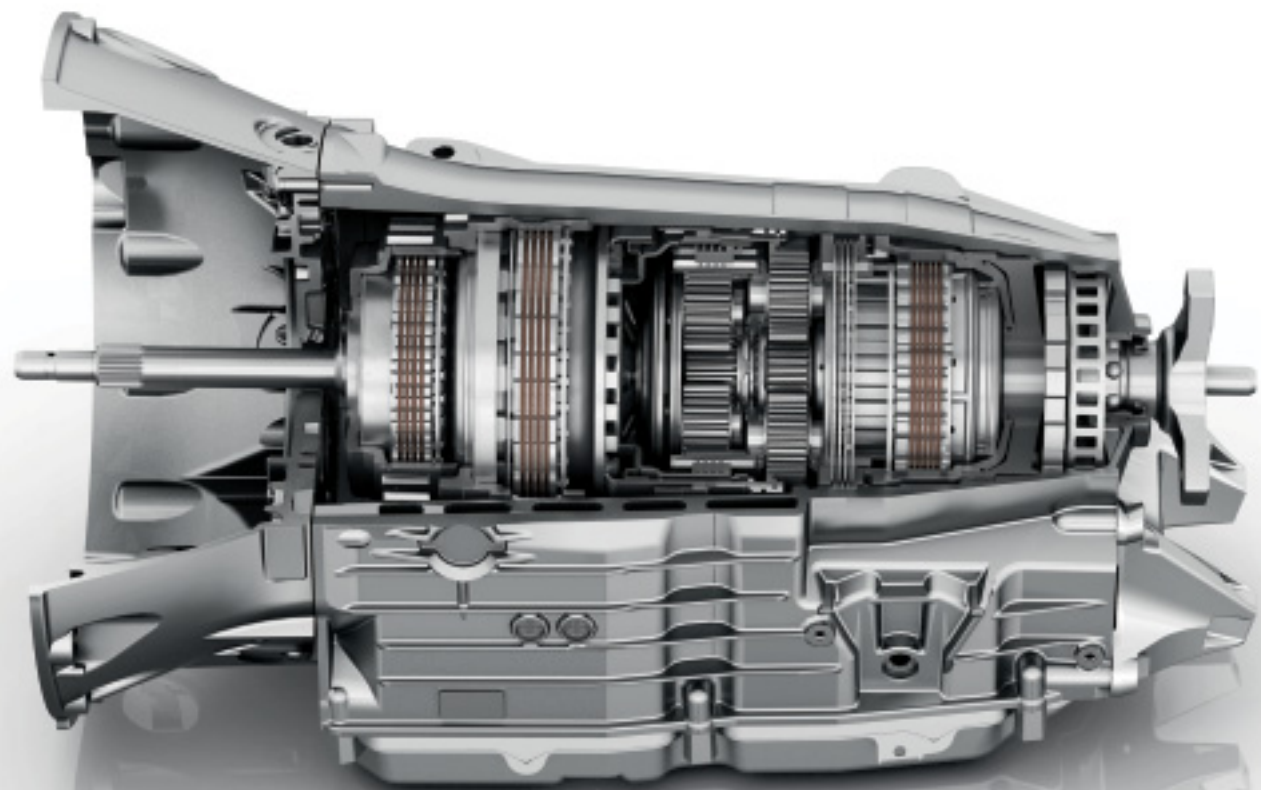

There's nothing you can't handle.

Marvel at the SL-Class' standard Active Body Control (ABC) system as it helps deliver the perfect ride. Ten sensors monitor the vehicle's handling. Continuous automatic adjustment of each wheel's suspension counteracts vibration, roll, pitching and braking. Lateral movements are also reduced when cornering. The suspension is automatically lowered at higher speeds.

Sport mode offers a quicker steering response than Comfort mode, a firmer suspension and an even smaller roll angle. This results in a sensational driving experience while enhancing safety, too. Drivers also benefit from electronic power assistance when steering at lower speeds or during difficult maneuvering.

For added convenience, have DISTRONIC proximity control fitted as an option and take cruise control to a whole new level. At speeds from 30-180 km/h, radar sensors automatically keep you at a safe and constant distance from the vehicle in front of you. Plus, the standard PARKTRONIC feature helps you park, with audible and visual warnings when objects are in close proximity.

The Active Body Control system continuously adjusts each wheel's suspension, improving pitching and rolling while cornering.







Explore the road less traveled in total confidence.

Whichever route you choose, you'll always be taking the safe road with the SL-Class thanks to the pioneering safety technology on board. It allows you to indulge in the roadster experience while enjoying the feeling of safety associated with a sedan.

The Electronic Stability Program (ESP®) can dramatically enhance cornering control by monitoring your steering and braking actions and responding nearly instantaneously if it detects a loss of directional control or stability¹. If your SL-Class begins to fishtail (oversteer) or plow (understeer), ESP® can apply the brakes to any of the four wheels or reduce excess power to help you regain control and stay on course.

Active Bi-Xenon headlights come standard on all models, providing much better illumination than conventional headlights. The cornering light function uses a wider fog lamp beam to illuminate the road in the direction you are turning. This effectively allows you to see around dark corners and respond to potential hazards accordingly.

¹No system, regardless of how advanced, can overcome the laws of physics or correct careless driving. Please always wear your seat belt. Best performance in snow is obtained with winter tires.

The Electronic Stability Program is complemented and enhanced by our ADAPTIVE BRAKE system, which provides a brake-drying function for wet weather. So you'll have total control, no matter what the road conditions.







Proven safety for the road ahead.

Mercedes-Benz has led the way in roadster safety since 1989 when it fitted the first ever sensor-controlled rollover bar as standard in the SL-Class. Normally concealed out of sight, it can extend fully in just 0.3 seconds the instant danger is sensed. At the heart of this technology is a tilting-cone sensor that works with an electronic control unit to detect when the SL-Class is at a critical tilt angle. Plus, an acceleration sensor keeps an eye on the roadster's current status so that the rollover bar can also be deployed automatically if the vehicle is involved in a collision from the front, side or rear. A preloaded spring makes sure the rollover bar is ready for action at any time, but it can also be raised and lowered manually at the push of a button.

And if the worst should happen, rest assured that the SL-Class offers you the best possible protection. The driver and passenger air bags¹ trigger in a matter of milliseconds in the event of a collision, and the large-capacity head/thorax air bags on both sides inflate in response to a side impact to form a protective cushion between you and the door. Post-accident functions include automatic engine shut-off and a signal sent to the TeleAid² Emergency Response Center, where trained specialists can assess the situation and alert emergency services. Mercedes-Benz knows full well that when it comes to safety, time is of the essence.

¹WARNING: The forces of a deploying air bag can cause serious or fatal injuries to a child under age 13. See Operator's Manual for additional warnings and information on air bags, seat belts and child seats. ²First year's monitoring provided at no cost with subscription. Subscription is required for service to be active. TeleAid operates only where cellular and Global Positioning System coverage is available.



AMG



Peerless and powerful.

AMG and SL – two sets of letters that are synonymous with motoring passion and exclusivity. When fused together, the result is two sensational sport cars.

Both AMG SL-Class models feature aggressive and dominating exteriors. Sharply defined edges and lines flow from the large front air dam and chrome-ringed fog lamps, right to the twin chromed tailpipes and a diffuser-ridged rear apron. The effect is captivating.

The SL63 AMG features a 6.2-litre 32-valve V-8, with 518 hp available at 6,800 rpm and 465 lb-ft of torque. This impressive power plant is managed perfectly by the revolutionary AMG SPEEDSHIFT MCT 7-speed sport transmission. Distinctive AMG 19" 5-triple spoke alloy wheels and performance tires complete the package.

The most powerful model in the SL-Class range and the most powerful production roadster in the world is the SL65 AMG. A twin-turbocharged 6.0-litre V-12 engine with 603 hp and 738 lb-ft of torque make it something of a rarity. The speedometer needle passes the 100 km/h mark in a breathtaking 4.2 seconds. AMG 19" 5-twin spoke alloy wheels and performance tires add a striking final touch.

Simply put, these roadsters are without peers. Perhaps that's why the SL-Class has been named Official F1 Safety Car for 2009.

The soul of a racecar.

The interiors of the SL63 AMG and SL65 AMG boast genuine AMG Carbon Fibre trim, providing authentic motor sport ambiance. This theme is reflected in the high-quality Nappa leather¹, which covers the seats, the door centre panels, the armrests, and even the instrument cluster. The AMG sports seats not only look sporty, they also provide optimal lateral support when cornering at speed.

The sportiest of driving is controlled by the AMG ergonomic sports steering wheel. Aluminium shift paddles provide fast gear changing. Another detail of the SL-Class AMG models: the RACETIMER integrated in the AMG instrument cluster. This feature allows you to measure and better your lap times. The red needles on the silver instruments are particularly exhilarating – in terms of looks and the speed at which they race round the dials.

Adjust for optimum driving with a variety of controls right at your fingertips. Climate Comfort seating controls, seat adjustment, heating and ventilation controls, as well as memorized seat position controls are conveniently situated on the doors.

Behind the wheel, it's impossible not to notice the combination of exceptional beauty and functionality of the intuitively laid out cockpit. This high design will fully prepare you for the ultimate ride that the SL-Class delivers.



¹Standard in the SL63 AMG. Exclusive Nappa leather standard in the SL65 AMG. Exclusive Nappa leather not available on the SL63 AMG.



What shade is your personality?



Wonderfully sophisticated and refined colours have been created using the most technologically advanced materials. A protective clearcoat gives your automobile a scratch resistance unparalleled in the automobile industry. This standard finish is three times more scratch-resistant than previous clearcoats, maintaining the attractive, high-quality appearance of your automobile over the long term.

	LEATHER					NAPPA LEATHER		EXCLUSIVE NAPPA LEATHER						
	Black/Black	Natural Beige/Black	Pebble Beige/Dark Pearl	Flamenco Red/Black	Alpaca Grey/Dark Alpaca Grey	Black/Black	Pebble Beige/Dark Pearl	Flamenco Red/Black	Alpaca Grey/Dark Alpaca Grey	Black/Black	Natural Beige/Black	Pebble Beige/Dark Pearl	Flamenco Red/Black	Alpaca Grey/Dark Alpaca Grey
SOLID PAINT														
Black	●	●	●	●	●	●	●	●	●	●	●	●	●	●
Fire Opal	●	○	●	●	○	●	●	●	○	●	○	●	●	○
METALLIC PAINT														
Chromite Black	●	●	●	●	●	●	●	●	●	●	●	●	●	●
Obsidian Black	●	●	●	●	●	●	●	●	●	●	●	●	●	●
Indigolite Blue	●	○	●	○	●	●	●	○	●	●	○	●	○	●
Thulite Red	●	○	●	○	○	●	●	○	○	●	○	●	○	○
Pearl Beige	●	●	●	●	○	●	●	●	○	●	●	●	●	○
Tenorite Grey	●	○	●	●	○	●	●	●	○	●	○	●	●	○
Palladium Silver	●	○	○	●	●	●	○	●	●	●	○	○	●	●
Alabandine Grey	●	○	○	●	●	●	○	●	●	●	○	○	●	●
Diamond White Bright	●	●	○	●	●	●	○	●	●	●	●	○	●	●
Iridium Silver	●	●	○	●	○	●	○	●	○	●	●	○	●	○

● Recommended combination ○ Possible combination

SOLID PAINT



040 Black



590 Fire Opal

METALLIC PAINT (OPTIONAL)



112 Chromite Black



197 Obsidian Black



230 Indigolite Blue



541 Thulite Red

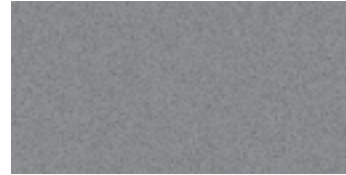

755 Tenorite Grey



794 Pearl Beige



792 Palladium Silver



779 Alabandine Grey



775 Iridium Silver

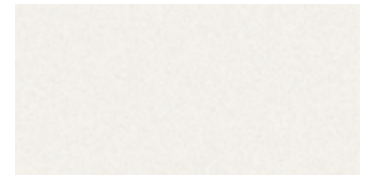

799 Diamond White Bright

LEATHER

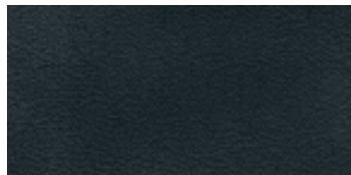

211 Black / Black

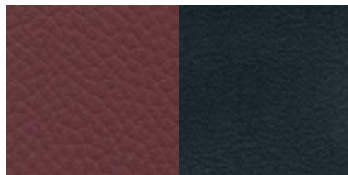

217 Flamenco Red / Black



214 Natural Beige / Black

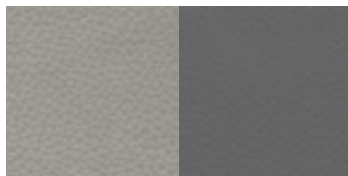

218 Alpaca Grey / Dark Alpaca Grey



215 Pebble Beige / Dark Pearl

NAPPA LEATHER

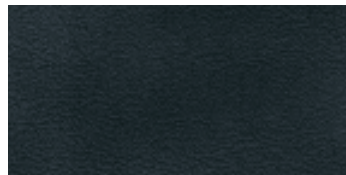

211 Black / Black



215 Pebble Beige / Dark Pearl

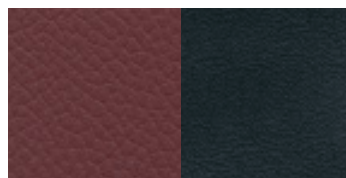

217 Flamenco Red / Black

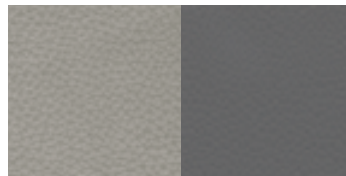

218 Alpaca Grey / Dark Alpaca Grey

EXCLUSIVE NAPPA LEATHER

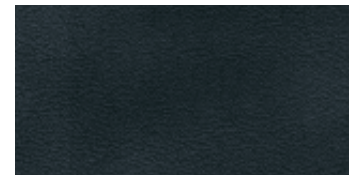

511 Black / Black

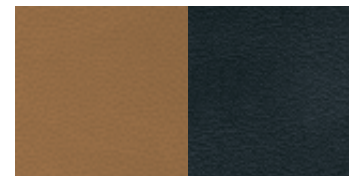

514 Natural Beige / Black

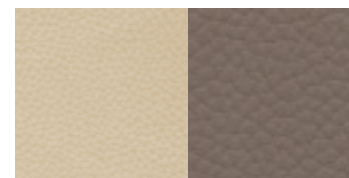

515 Pebble Beige / Dark Pearl

TRIM

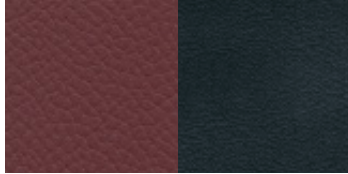

517 Flamenco Red/Black



731 Burl Walnut (high-gloss)



H12 Light Burl Walnut

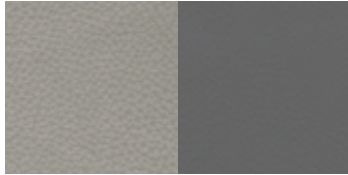

518 Alpaca Grey/Dark Alpaca Grey

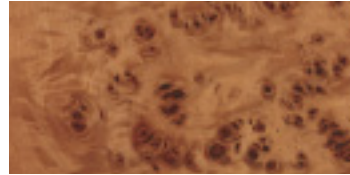

729 Natural Poplar



H73 AMG Carbon Fibre



736 Dark Ash

designo
ALCANTARA ROOF LINER¹

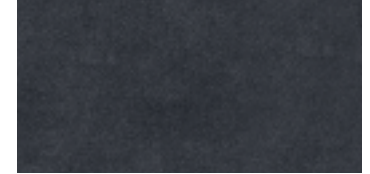

Y83 Anthracite



Y84 Pebble Beige



Y85 Alpaca Grey

¹Standard on the SL600, SL63 AMG and SL65 AMG. Available on the SL550 through our regular *designo* program. See dealer for details.

Luxury just how you like it.

Knowing that your automobile will be a bold extension of your personality, we created the *designo* line of exterior paint finishes, interior leather upholstery, and interior trim. The SL-Class roadsters offer an exclusive range of *designo* metallic paint finishes, and inside, a variety of single and two-tone *designo* leather upholstery finishes. But the choice of upholstery colour is only the first of many decisions.

designo trim elements include a selection of woods as well as fine granite. Wood selections include maple grain with a *designo* natural or *designo* umber finish, and oak grain in the *designo* matte natural finish. By contrast, the Labrador blue pearl and black Star Galaxy stone trims make an elegantly sporty statement.

See your dealer for details.





What comes between you and the road.

Grabbing the eye as well as they grip the road, all SL-Class wheels are designed with the same philosophy as the rest of this inspired vehicle. Style, substance and safety are the cornerstones of Mercedes-Benz, and none of them were spared while developing these impressive wheels.



AMG 19" 5-spoke alloy wheel



AMG 19" 5-triple-spoke alloy wheel



AMG 19" 5-twin-spoke alloy wheel





S° SL 5502

S° SL 6001

INDIVIDUAL EQUIPMENT (SELECTION)	SL550	SL600	SL63 AMG	SL65 AMG
TRANSMISSION				
7G-TRONIC 7-speed automatic transmission	●	-	-	-
5-speed automatic transmission with Touch Shift	-	●	-	-
AMG SPEEDSHIFT MCT 7-speed sports transmission	-	-	●	-
AMG SPEEDSHIFT 5-speed automatic transmission	-	-	-	●
TRACTION/STABILITY				
Active Body Control (ABC)	●	●	●	●
Electronic Stability Program (ESP®) including ABS and traction control (ASR)	●	●	●	●
Sensotronic Brake Control (SBC) with Brake Assist (BAS)	●	●	●	●
Limited slip rear differential	-	-	○ ¹	-
AUDIO/VISUAL/COMMUNICATION				
COMAND APS with hard drive-based navigation, DVD changer, Music Register and SD memory card slot	●	●	●	●
harman/kardon® LOGIC7® surround sound system	●	●	●	●
Media interface (with iPod®, USB and auxiliary connections)	●	●	●	●
SIRIUS Satellite Radio ²	●	●	●	●
Bluetooth connectivity	●	●	●	●
LINGUATRONIC voice control	●	●	●	●
EXTERIOR				
AMG 19" 5-spoke alloy wheels	●	●	-	-
AMG 19" 5-triple spoke alloy wheels	-	-	●	-
AMG 19" 5-twin spoke forged alloy wheels	-	-	○ ¹	●
AMG Styling Package (front apron, side skirts and rear apron)	●	●	●	●
Active Bi-Xenon headlamps with washers and cornering lights	●	●	●	●
Electronically adjustable heated exterior mirrors with turn signal indicators and power folding function	●	●	●	●

INDIVIDUAL EQUIPMENT (SELECTION)	SL550	SL600	SL63 AMG	SL65 AMG
Heated windshield washer system with two-stage rain-sensing windshield wipers	●	●	●	●
Remote trunk release	●	●	●	●
Tinted glass	●	●	●	●
INTERIOR				
Multicontour driver and passenger seats with 3-position memory and massage function	●	●	●	●
Climate Comfort seats (heated and ventilated, with perforated leather)	○ ¹	●	○ ¹	●
Burl Walnut wood trim (high-gloss)	●	●	○ ⁴	○ ⁴
AMG Carbon Fibre trim	-	-	●	●
Light Burl Walnut wood trim	○	○	○ ³	○ ⁴
Dark Ash wood trim	○	○	○ ⁴	○ ⁴
Natural Poplar wood trim	-	○	-	○ ⁴
Leather upholstery	●	-	-	-
Nappa leather upholstery	-	-	●	-
Exclusive Nappa Leather upholstery	-	●	-	●
<i>designo</i> Alcantara roof liner	-	●	●	●
3-spoke leather/wood multifunction steering wheel	●	●	○ ⁵	○ ⁵
Leather-wrapped multifunction sport steering wheel and shift knob	-	-	●	●
Steering wheel shift paddles	●	●	●	●
Panoramic vario-roof	○ ¹	●	○ ¹	●
AIRSCARF	○ ¹	●	○ ¹	●
THERMOTRONIC dual-zone automatic climate control	●	●	●	●
Auto-dimming mirrors (rearview and driver's side)	●	●	●	●

INDIVIDUAL EQUIPMENT (SELECTION)	SL550	SL600	SL63 AMG	SL65 AMG
Power-tilt/telescoping steering column with 3-position memory	●	●	●	●
Power windows with one-touch express up and down	●	●	●	●
Fabric windscreen	●	●	●	●
Rear luggage belts	●	●	●	●
CONVENIENCE				
PARKTRONIC	●	●	●	●
DISTRONIC	○	○	○	○
Cruise control	●	●	●	●
SmartKey with panic button	●	●	●	●
KEYLESS-GO	○ ¹	●	●	●
Electronic trunk closure	○ ¹	●	○ ¹	●
Integrated garage door opener	●	●	●	●
Valet trunk locking	●	●	●	●
Locator lighting with headlamp switch-off delay	●	●	●	●
Steering wheel moves up automatically for easier entry and exit (EASY-ENTRY)	●	●	●	●
SAFETY				
TeleAid Emergency Calling System ⁶	●	●	●	●
Anti-theft alarm system with tow-away protection	●	●	●	●
Dual-front air bags and head/thorax side air bags	●	●	●	●
Two 3-point height-adjustable seat belts	●	●	●	●
Belt tensioners with belt-force limiters	●	●	●	●
Tire Pressure Monitoring System	●	●	●	●
First aid kit	●	●	●	●

EQUIPMENT PACKAGES	SL550	SL600	SL63 AMG	SL65 AMG
SL550 PREMIUM PACKAGE:				
Climate Comfort seats. Panoramic vario-roof. AIRSCARF. KEYLESS-GO. Electronic trunk closure.	○	-	-	-
SL63 AMG PREMIUM PACKAGE:				
Climate Comfort seats. Panoramic vario-roof. AIRSCARF. Electronic trunk closure.	-	-	○	-
AMG PERFORMANCE PACKAGE:				
AMG 19" 5-twin-spoke alloy wheels. Sport suspension. Limited slip rear differential. AMG performance steering wheel. Electronic speed limiter deletion ⁷	-	-	○	-

● Standard ○ Optional - Not Available

¹Only available as part of an option package. ²Complimentary six months of service included. Monthly subscription required for service thereafter. ³Includes matching wood and leather steering wheel. Not available in conjunction with the AMG Performance Package. ⁴Includes matching wood and leather steering wheel. ⁵Available in conjunction with any optional wood trim choice on the SL63 AMG and SL65 AMG. ⁶First year's monitoring provided at no cost with subscription. Subscription is required for service to be active. TeleAid operates only where cellular and Global Positioning System coverage is available. ⁷Intended for track use only. Please obey all speed laws.

For that finishing touch of class.



Add beauty, functionality, detail and luxury. In fact, add as much as you'd like from our elaborate range of genuine Mercedes-Benz Accessories. They're the best way to personalize your SL-Class and give it a final touch of added class.

Car Cover

The custom Car Cover will protect your SL-Class from all the elements.



Trunk Tray

This shallow Trunk Tray is precision tailored, and made from non-slip materials. Keep your trunk clean, and protect it against spillage.



AMG 18" ultra-thin multi-spoke alloy wheels

Augment the bold statement made by your new SL-Class with the powerful look of AMG 18" ultra-thin multi-spoke alloy wheels.



AMG Rear Apron

AMG rear apron with AMG dual-twin pipe exhaust adds a further refined look to the rear of your vehicle.



	SL550	SL600	SL63 AMG	SL65 AMG
Engine type	DOHC 32-valve V-8	SOHC bi-turbo 36-valve V-12	DOHC 32-valve V-8	SOHC bi-turbo 36-valve V-12
Total displacement	5,461-cc	5,513-cc	6,208-cc	5,980-cc
Net power	382 hp @ 6,000 rpm	510 hp @ 5,000 rpm	518 hp @ 6,800 rpm	603 hp @ 4,800 rpm
Net torque	391 lb-ft @ 2,800-4,800 rpm	612 lb-ft @ 1,900-3,500 rpm	465 lb-ft @ 5,200 rpm	738 lb-ft @ 2,000-4,000 rpm
Acceleration, 0-100 km/h ¹	5.4 seconds	4.5 seconds	4.6 seconds	4.2 seconds
Approximate top speed ²	210 km/h	210 km/h	250 km/h	250 km/h
Tires, front rear	255/35 R 19 285/30 R 19	255/35 R 19 285/30 R 19	255/35 R 19 285/30 R 19	255/35 R 19 285/30 R 19
Fuel economy ³ , city/highway estimate	15.8-9.4 L/100 km	18.5-11.4 L/100 km	17.9-10.6 L/100 km	18.5-11.2 L/100 km
Fuel tank capacity	80.0 litres (with 10.0-litre reserve)	80.0 litres (with 10.0-litre reserve)	80.0 litres (with 10.0-litre reserve)	80.0 litres (with 10.0-litre reserve)
Fuel requirement	Premium unleaded gasoline	Premium unleaded gasoline	Premium unleaded gasoline	Premium unleaded gasoline
Dimensions ⁴				
Wheelbase	100.1 in/2,560 mm	100.1 in/2,560 mm	100.1 in/2,560 mm	100.1 in/2,560 mm
Overall length	179.6 in/4,562 mm	179.6 in/4,562 mm	181.3 in/4,605 mm	181.3 in/4,605 mm
Overall height	50.1 in/1,295 mm	50.1 in/1,295 mm	50.1 in/1,295 mm	50.1 in/1,295 mm
Overall width incl. mirrors	81.5 in/2,069 mm	81.5 in/2,069 mm	81.5 in/2,069 mm	80.0 in/2,033 mm
Curb weight	4,222 lb/1,915 kg	4,497 lb/2,040 kg	4,398 lb/1,995 kg	4,552 lb/2,065 kg
Trunk Capacity	10.2 cu ft/288 litres	10.2 cu ft/288 litres	10.2 cu ft/288 litres	10.2 cu ft/288 litres

¹Stated rates of acceleration are based on manufacturer's track results and may vary depending upon model, environmental and road surface conditions, driving style, elevation and vehicle load. ²Electronically limited. ³These estimates are based on Transport Canada testing methods. The actual fuel consumption of this vehicle may vary. Refer to *Fuel Consumption Guide*. ⁴Dimensions shown are for models with standard equipment.

A passion for things done right.

It's what you expect from Mercedes-Benz. A passion for craftsmanship and attention to detail is what sets Mercedes-Benz apart from all other manufacturers. This passion drives us to set new standards in design, performance, comfort and safety. To continually build on the legendary traditions of Mercedes-Benz. And to provide you with an ownership experience unlike any other, including the valuable benefits described below.

24-hour Roadside Assistance

During the basic warranty coverage of 48 months and the time duration of the optional Extended Limited Warranty, Mercedes-Benz Roadside Assistance will be at your service. We'll bring you some gas, replace a flat tire with your spare, or jumpstart your car. In the event of a mechanical breakdown, if attempts by our Roadside Assistance technician have not made your vehicle safely operable, towing service will be provided to the nearest Mercedes-Benz dealership. Assistance is available 24 hours a day, every day, to anyone driving a Mercedes-Benz anywhere in Canada or the continental U.S.¹

Wear and tear period

The following parts listed are covered for wear and tear during the first 24 months or 40,000 km whichever comes first. Brake pads, brake discs, brake pad wear sensors and light bulbs.

Mercedes-Benz warranties

The Mercedes-Benz New Vehicle Limited Warranty covers defects in materials or workmanship for 48 months or 80,000 km, whichever occurs first. To widen your window of confidence, you can opt for a Mercedes-Benz Extended Limited Warranty as well.²

Customer service

Owning a Mercedes-Benz means that when you have a question, we're here to help. Customer Service is open from 9 a.m. to 5 p.m. EST, Monday through Friday, and is staffed with knowledgeable Mercedes-Benz people who can talk you through the finer points of working your car's audio system – or even assist you in locating the nearest Mercedes-Benz dealership. Just call 1-800-387-0100. It's that simple.

Trip interruption reimbursement

If a breakdown covered by your New Vehicle Limited Warranty or optional Extended Limited Warranty occurs more than 80 km from your home, leaves your Mercedes-Benz vehicle inoperable or unsafe to drive, and requires overnight repairs, we've got you covered. You will be reimbursed up to \$500 for hotel accommodations and up to \$600 for alternative travel expenses per incident while your car is being repaired at an authorized Mercedes-Benz dealership.

¹Vehicle must be accessible from main roads. Roadside Assistance may involve charges for parts, service and towing. Depending on the circumstances, these services may be provided by an outside service provider, courtesy of Mercedes-Benz Roadside Assistance. For full details of the Roadside Assistance Program, please see your dealer. ²Please see your dealer for warranty details as well as for terms, conditions and pricing for extended warranty options.

There's virtually so much more.

Visit mercedes-benz.ca and open an online window to Mercedes-Benz Canada. Revel in the incredible photography of our vehicles and get a visceral impression of what it would be like to see yourself behind the wheel. Get information about any of our vehicles, including financing and leasing options, upcoming models, and how to configure your own ideal Mercedes online. Our website also offers details about the Mercedes-Benz Extended Limited Warranty, vehicle ownership, and much more on the fascinating story behind one of the world's most recognizable brands.



To be continued. With a test drive.

Nowhere is a Mercedes-Benz so convincing as on the road. It is only there that you can fully experience the effortlessly superior handling that makes this car so special. You can feel how the powerful engine drives the vehicle onwards and how the precise steering movements have a direct effect on your own mood. The special atmosphere that arises during a drive in a Mercedes-Benz cannot be put down on paper. That's why we would like to invite you to reserve an appointment for a test drive at your local Mercedes-Benz dealer. Or visit www.mercedes-benz.ca. We look forward to seeing you.





© 2009 Mercedes-Benz Canada Inc.

All illustrations and specifications contained in this brochure are based on the latest product information available at the time of publication. Mercedes-Benz Canada reserves the right to make changes at any time, without notice, in colours, materials, equipment, specifications and models. Any inaccuracies in colours shown are due to reproduction variations of the printing process. Some vehicles may be shown with non-Canadian equipment. Some vehicles may be shown without side marker lights. Some vehicles are shown with optional equipment available at extra cost. Some optional equipment may not be available on all models. For current information regarding the range of models, standard features, optional equipment and/or colours available in Canada and their pricing, contact your nearest authorized Mercedes-Benz dealer or visit mercedes-benz.ca. harman/kardon and LOGIC7 are registered trademarks of Harman International Industries Inc. iPod is a registered trademark of Apple Computer, Inc.

Printed in Canada
MBC-09-SL10-4950E

Mercedes-Benz Canada Inc. 98 Vanderhoof Avenue, Toronto, Ontario M4G 4C9
1-800-387-0100
www.mercedes-benz.ca

