

This brochure has been compiled by DaimlerChrysler AG of Germany and is distributed internationally. It provides a general indication of the range of models, features, optional extras and/or colours available in various countries. Some of the models, features, optional extras and/or colours shown may not be available in your country or may only be available in a different specification. Additionally some models, features, optional extras and/or colours may only be available in combination with others. For current and more specific information in relation to the range of models, features, optional extras and/or colours available in your country, and their pricing, you should contact your nearest authorised Mercedes-Benz Passenger Car Dealer.





THE NEW M-CLASS



Mercedes-Benz

Refined power. The new M-Class





ML350 with AMG bodystyling and 19-inch AMG light-alloy wheels

Contents

04	The new M-Class
10	Engines
18	AIRMATIC
20	Off-road performance
22	Dynamic handling
30	Comfort
32	Flexibility
34	Load capacity
36	AMG
44	Safety
46	Standard equipment and optional extras
56	Wheels
58	Accessories
61	Paintwork and upholstery
66	Technical data
68	Glossary
74	Dimensions
76	Gallery

Built for the road. And the way there

There are many places worth visiting simply because they are so far off the beaten track. The new M-Class will get you there without a hint of fuss. Whether you're heading through rough terrain to get to dead straight roads or the other way around, the M-Class is ready to tackle whatever lies ahead.

It's comfort and convenience all the way in the M-Class. Features such as the standard-fit 7 G-TRONIC automatic transmission and permanent all-wheel drive with the Electronic Traction System (4ETS) make sure of that, while the robust engines take care of deliciously sweet power delivery. And as you settle into the ergonomically styled seats, you will be able to look forward to a gentle ride on even the most bone-jarring routes. More convenience and comfort still comes in the form of the multi-function steering wheel with DIRECT SELECT steering-wheel gearshift buttons, as well as the refined interior appointments. And for added peace of mind, there's the optional PRE-SAFE® system.









Comfort and high-grade materials hallmark the interior of the new M-Class. The sense of indulgence begins with the standard multi-function steering wheel, which allows you not only to operate the radio and the telephone but also to change gear without taking your hands off the wheel. Quality in its finest form also materialises in features such as tubular instrument cluster gauges, circular air vents and matt-finish aluminium. Leather-upholstered seats and wood trim with chrome inlay are available optionally





If the M-Class is too quiet for you, just revel in the sounds of the great outdoors

Six cylinders serve up the power in each of the two CDI diesel engines available for the new M-Class. Despite their hushed running characteristics, these units deliver exemplary performance whilst still being frugal with the fuel. Plus, both come with a diesel particulate filter as standard.

The ML 280 CDI generates 140 kW (190 hp) with a peak torque of 440 Nm, accelerates from 0 to 100 km/h in 9.8 seconds and goes on to reach a top speed of 205 km/h.

The sheer motoring pleasure offered by the ML 320 CDI also stems from third-generation common-rail direct injection technology. With maximum power of 165 kW (224 hp), 510 Nm of peak torque, a top speed of 215 km/h and a 0 to 100 km/h acceleration time of 8.6 seconds this model has all the right credentials for eating up the miles on-road and making effortless progress through demanding terrain off-road.

ML 320 CDI with sports package





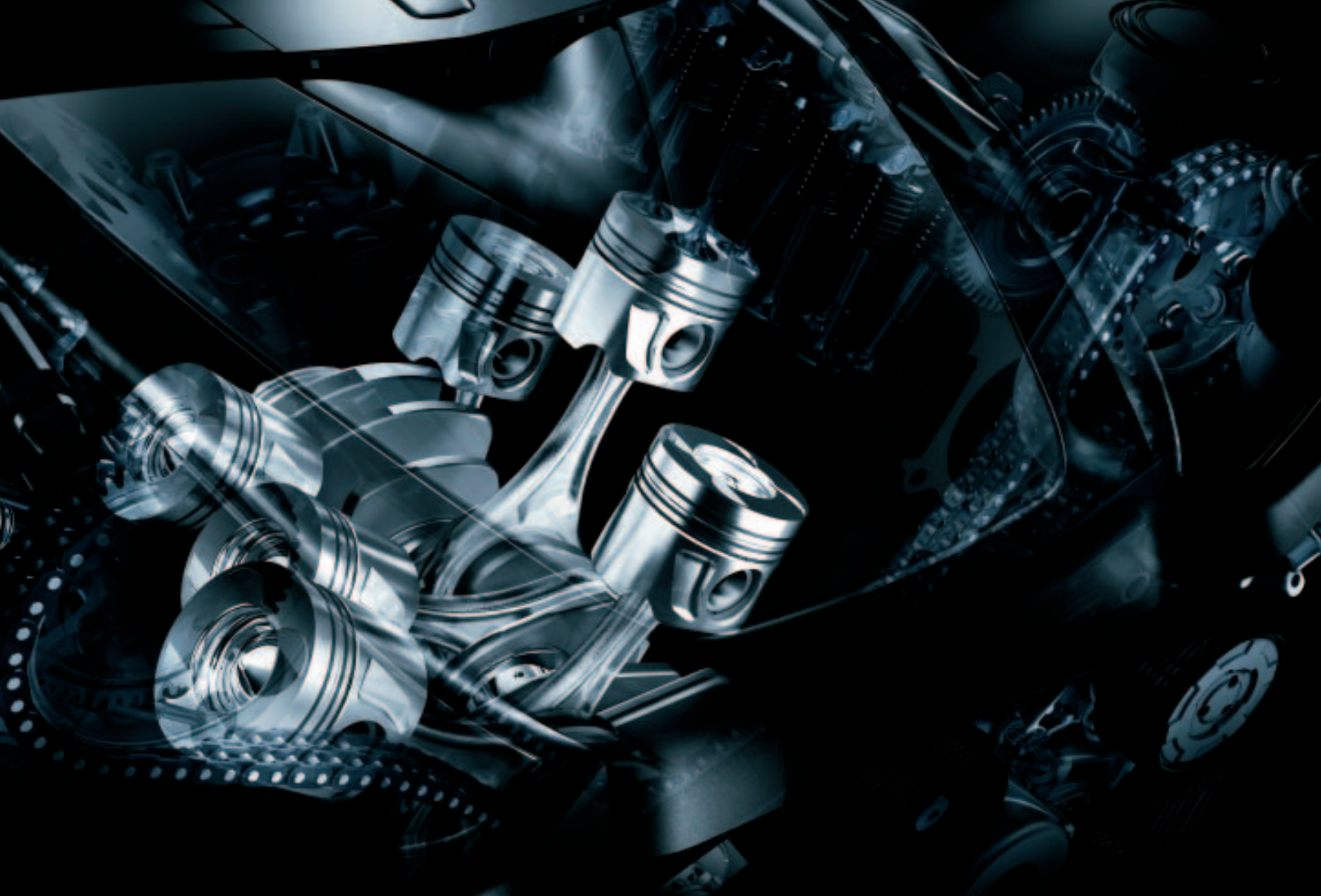

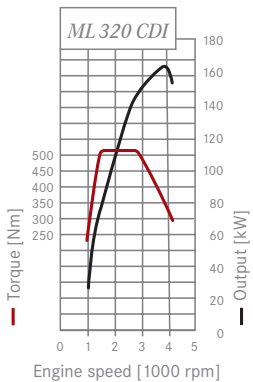
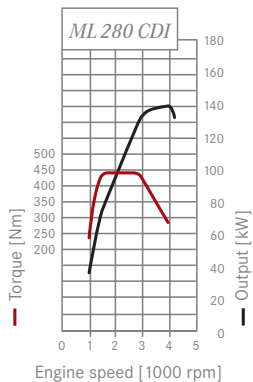

Pressure can be a wonderful thing

With common-rail direct injection in the new M-Class's diesel-powered V6 units, you can feel the full power of the engine even on gentle acceleration. That's partly down to the new piezo injectors: fine crystals, which contract when voltage is applied, ensure that the fuel is metered more precisely than ever before. It is injected into the cylinders at up to 1600 bar. The nozzles now have eight holes for extra-fine distribution of the diesel fuel.



You don't have to go to the opera to enjoy cultured sounds

You can look forward to experiencing an exceptional expression of driving culture when you opt for one of the two petrol-powered M-Class models. The new 6-cylinder engine in the ML350 can boast a repertoire consisting of refined running blended with top performance and high torque levels. Improved fuel economy and low pollutant emissions round off the flawless performance. It's all down to the cutting-edge 4-valves-per-cylinder design, optimised intake ducts with electropneumatically controlled tumble flaps and refinements made to all the air-ducting parts.

If 8-cylinder power and smoothness are what you want, you need look no further than the ML500. Despite the fact that the output has been increased, this engine now also consumes significantly less fuel.

ML 500





Impressive curves – especially on the straight

A glance at the performance curves tells you that high performance is available at low engine speeds. The new ML 350 has an output of 200 kW (272 hp) and a maximum torque of 350 Nm. And while it's hard to do justice to the pure power of the ML 500 in words, it is easy to put a figure on it: it has an output of 225 kW (306 hp) and its maximum torque is 460 Nm. It accelerates from 0 to 100 km/h in 6.9 seconds and peaks at a top speed of 240 km/h.

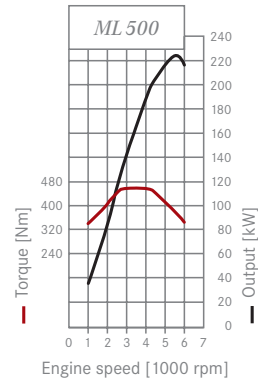
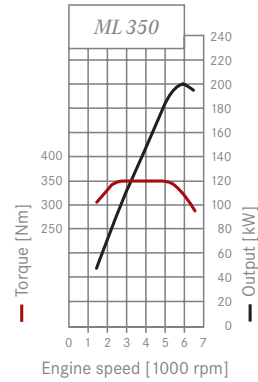



The world's smallest jack: your little finger

We take driving enjoyment to new levels – quite literally, with the optional AIRMATIC package. It includes the Adaptive Damping System (ADS) with its three damper settings “Auto”, “Sport” and “Comfort”. When travelling at speed, the ride height of the M-Class is automatically lowered. This minimises drag, reducing fuel consumption, while the lower centre of gravity enhances dynamic handling. To ensure that your enjoyment isn't diminished when travelling with a high payload, air suspension keeps the level of the vehicle constant at all times. Off-road, you can raise the ride height by up to 80 mm (or up to 110 mm with the Off-Road Pro engineering package) at the touch of a button.





The M-Class keeps you on the right track: off-road or on, you are assisted by the standard 4ETS/ESP® dynamic handling system, which incorporates anti-lock braking (ABS) and acceleration skid control (ASR). 4ETS/ESP® intervenes in critical situations, triggering selective braking of individual wheels, for example, in order to stabilise the vehicle. When negotiating steep off-road descents, you are supported by Downhill Speed Regulation (DSR), another standard feature. At the touch of a button, you can maintain any selected speed between 4 and 18 km/h

The perfect substitute for any road: the off-road switch

The joy of driving the M-Class continues long after you've run out of tarmac. Simply press the standard off-road switch, and all of the M-Class's electronic systems are primed for off-road driving and extra traction. Transmission shifts are delayed and the fuel is metered with greater precision for more controlled acceleration.

For those who like to explore even more extreme terrain, we recommend the optional Off-Road Pro engineering package (not available for the ML 63 AMG). This comprises two manually selectable 100 % differential locks, a two-speed transfer case (with a low range) and a reinforced rear-axle differential. You can switch between the 1:1 on-road ratio and the 2.93:1 off-road ratio as the situation dictates. AIRMATIC air suspension, which is also included with the Off-Road Pro engineering package (not available for the ML 63 AMG), enables the M-Class's ground clearance to be raised by up to 110 millimetres, which increases the maximum fording depth to 600 millimetres.





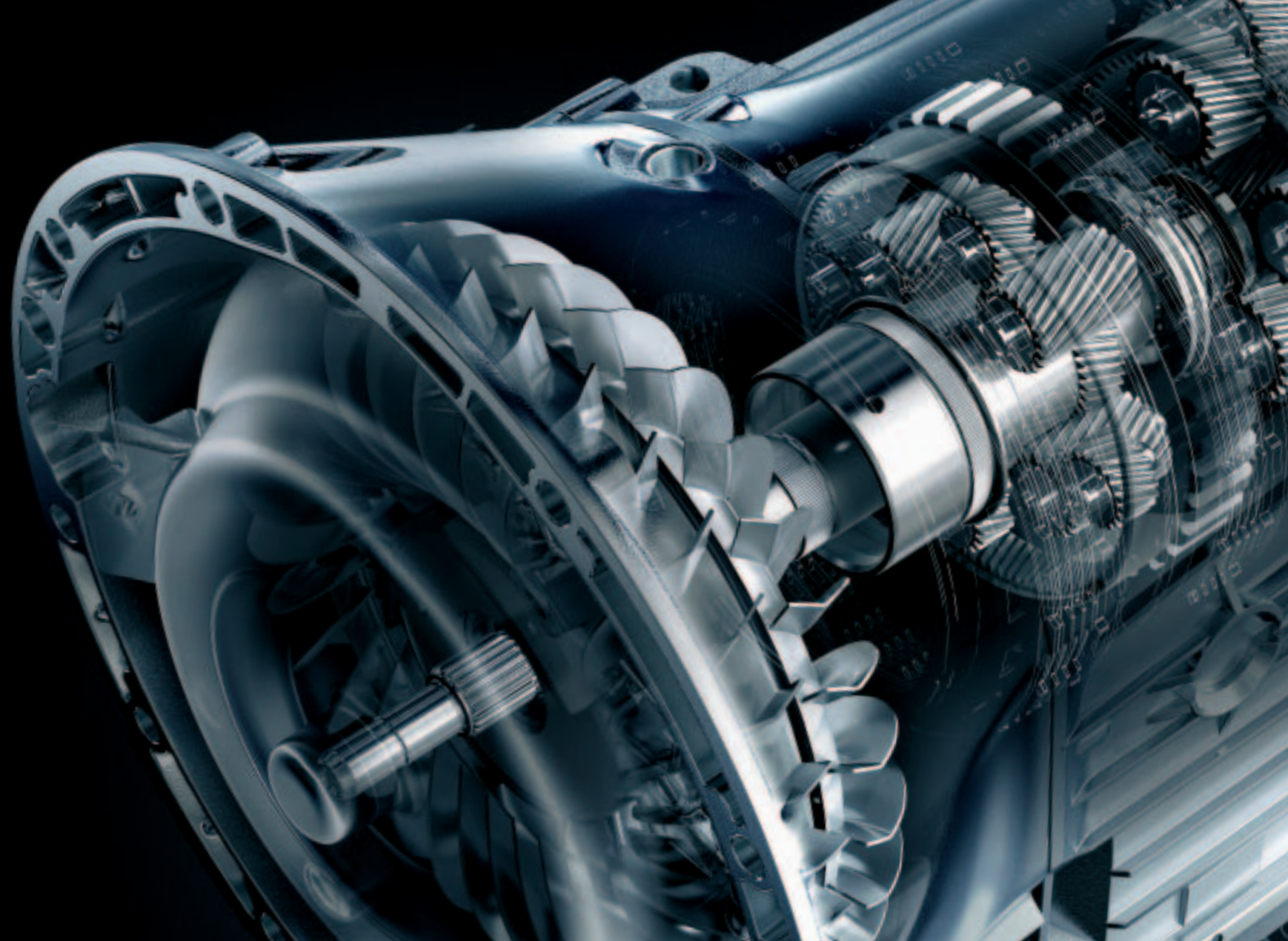



7G-TRONIC 7-speed automatic transmission

You could skip over this page and you'd still have grasped the principle of 7G-TRONIC

The M-Class is fitted as standard with the world's first 7-speed automatic transmission: 7G-TRONIC. Gears are selected directly, ensuring uninterrupted torque delivery, virtually imperceptible gearshifts and enhanced ride comfort. Should you need to brake sharply or want to accelerate briskly, 7G-TRONIC simply skips a few gears. The low engine speeds make for lower fuel consumption too.

If you feel like indulging your sporty instincts, you can opt to downshift manually using the standard DIRECT SELECT gearshift buttons on the steering wheel. The instrument cluster shows which gear range is currently selected.

The Off-Road Pro engineering package (not available for the ML 63 AMG) adds the option of selecting between Standard (S) and Manual (M) modes with 7G-TRONIC – with the latter the transmission only reacts when you make the gear changes.





ML 350 with sports package

The optional sports package underlines the M-Class's sporty genes. There are 19-inch light-alloy wheels, blue-tinted windows and a silver-painted radiator grille for the exterior. Sports seats in an Alcantara/ARTICO man-made leather combination, a sports instrument cluster, aluminium trim and sports pedals add a refined touch inside. The sports package also includes a separately available chrome package, which adds a sparkling touch to the exterior, the chromed features such as the square, chromed exhaust tailpipes emphasising the M-Class's aesthetic appeal



S 0F 3195



Still waters run deep... until you plough through them

The impressive fording depth of the M-Class ensures you will never find yourself all at sea, as you will be able to ford water up to 500 millimetres in depth with consummate ease. And if you opt for the Off-Road Pro engineering package (not available for the ML 63 AMG), the maximum fording depth increases to 600 millimetres.

ML 350 with sports package







No matter how slowly you take things,
you'll feel that the journey was over
too quickly

The generous sense of space, clearly arranged control elements and high-quality materials inside the M-Class ensure the highest degree of comfort on board. It starts the moment you open the doors – without having to take the key out of your pocket, thanks to KEYLESS-GO (available as an option). Inside, your gaze is drawn to the fine wood trim as you settle into your seat, which is upholstered in Aspen fabric/ARTICO man-made leather. If you prefer, fine leather, TWIN Leather or a combination of Alcantara/ARTICO man-made leather are available as optional extras. The multifunction steering wheel can be used to call up useful vehicle data, operate the radio and the telephone and even change gears using the gearshift buttons. As the selector lever is also positioned on the steering column, an additional stowage compartment is available in the centre console.

For pleasant temperatures at all times, THERMATIC automatic climate control is fitted as standard. Optional on-board technology includes the COMAND APS control and display system with DVD navigation system and the exclusive harman/kardon LOGIC 7® surround sound system.





Close the doors – and enjoy the sense of space

Plenty of headroom and legroom ensure that everyone on board is comfortable, even those in the rear. If, however, you need more room for luggage, the rear seat backrest can be folded forward – a few simple steps are all it takes. It has a 1/3 to 2/3 split, allowing either section to be folded forward separately. Removable rear seat cushions are available optionally and allow you to create a longer load space.



Most cars have four wheels on the outside. But inside?

You won't have to be too selective when deciding what to take with you on your travels in the M-Class; with a load space of between 551 and 2050 litres, it certainly won't cramp your style. Six load-securing rings make light work of tying down cargo, while smaller objects can be placed in the stowage compartment at the side. The EASY-PACK load-securing kit, including load-securing rails, can be ordered as an option. And if you want to take things really easy, why not opt for the hydraulic tailgate with pushbutton operation?





When you've got class, you look good in any situation

The M-Class is at its sportiest with AMG bodystyling, which features a front apron – with brushed stainless steel inlay – integral, circular fog lamps, ringed in chrome, and additional air intakes – plus a rear apron, painted in body colour with chromed scratch protection.

With a look this sporty, it's important to have the right wheels: the 19-inch, 5-spoke AMG light-alloy wheels, which are painted in sterling silver, harmonise perfectly with the AMG bodystyling.

ML350 with AMG bodystyling and 19-inch AMG light-alloy wheels









Attention - wild animal on the road

The new AMG 6.3-litre V8 engine, with its output of 375 kW (510 hp) and maximum torque of 630 Nm, makes the ML 63 AMG¹ an extraordinary phenomenon. And one you're only likely to catch the briefest of glimpses of, since it accelerates from 0 to 100 km/h in a breathtaking 5.0 seconds – up to an electronically governed top speed of 250 km/h. The AMG SPEEDSHIFT 7G-TRONIC delivers remarkably short gearshifts. And thanks to the AMG high-performance braking system, deceleration is equally impressive.

AMG sports suspension, based on the AIRMATIC package, delivers the output of the ML 63 AMG safely to the road. AMG spring struts and shock absorbers minimise roll and ensure optimum over/understeering characteristics. And the powerful sound comes courtesy of the AMG sports exhaust with its two chromed twin tailpipes.

In visual terms you can recognise the most powerful of all M-Class models by the high-shine 19-inch AMG light-alloy wheels and the AMG bodystyling, consisting of front and rear aprons. Further distinctive features: the AMG-specific radiator grille, wheel-arch flaring and stainless steel running boards.

¹Available from 2nd quarter of 2006





ML 63 AMG with optional 20-inch AMG light-alloy wheels

Open-air sport – with a roof over your head

Inside the ML 63 AMG¹ you'll find the perfect conditions for top performance. AMG sports seats with Alcantara panels in the shoulder area offer optimum support and, thanks to the multicontour function, are extremely comfortable too. The AMG ergonomic sports steering wheel with gearshift buttons and the AMG instrument cluster with a RACETIMER add a touch of motorsport. The nappa leather upholstery, the silver and black trim aluminium and the brushed stainless steel sports pedals create a particularly exclusive atmosphere.

The AMG bodystyling package¹ is available as an optional extra for every M-Class. In addition to the AMG bodystyling, it includes wheel-arch flaring and high-sheen 20-inch, size 295/40 R 20 AMG light-alloy wheels.

¹Available from 2nd quarter of 2006





Sometimes, being enclosed in a cage can be very liberating

The new M-Class features an extremely sturdy passenger cell that protects the occupants by virtue of its energy-absorbing front-end structure, reinforced doors, extended crumple zones and raised ride position. There are also multi-stage airbags and, as an option, the new NECK-PRO head restraints. Following an impact from the rear that exceeds a predefined threshold, the front head restraints move towards the occupant's head, preventing the risk of whiplash injuries. Prevention is also the principle behind PRE-SAFE®, an occupant protection system boasting a whole package of measures that are unleashed in a reflex reaction the moment an impending collision is detected.







One glance at the equipment and the driving enjoyment begins

The M-Class is designed to meet every requirement: take, for example, the Offroad switch in the centre console, which primes all the electronic systems for off-road driving.

The multifunction steering wheel allows you to operate the radio and adjust the volume, answer the phone and change gears using the DIRECT SELECT gearshift buttons. Behind the steering wheel is the DIRECT SELECT lever, which operates the standard 7G-TRONIC automatic transmission. And cruise control with the SPEEDTRONIC variable speed limiter makes for a relaxed and enjoyable drive.







Standard equipment

Selection

7-speed automatic transmission 7G-TRONIC
17-inch light-alloy wheels (ML 280 CDI, ML 320 CDI, ML 350)
18-inch light-alloy wheels (ML 500)
Anti-lock braking system (ABS)
Airbags for driver and front passenger, with two-stage deployment
Armrest in front, with compartment
Audio 20 CD radio with 8 loudspeakers
Brake Assist (BAS)
Downhill Speed Regulation (DSR)
DIRECT SELECT gearshift on steering column, with steering-wheel gearshift buttons
Electronic Stability Program (ESP®)
Electronic Traction System for all-wheel drive (4ETS)
Entry/exit lights in front and rear doors
Exterior mirrors, heated and electrically adjustable
Exhaust system, twin-pipe, with visible tailpipes
'Fasten seat belt' warning for front seats
Fog lamps

Headlamp Assist
Head restraints (5)
Leather multifunction steering wheel
Outside temperature display
Permanent all-wheel drive
Power windows (4) with one-touch control
Rear bench seat, split-folding (1/3 : 2/3)
Roll-over sensor
Sidebags for driver and front passenger
Simulated underbody guard, front/rear, with grained, silver-coloured finish
Speed-sensitive power steering
THERMATIC automatic climate control (THERMOTRONIC standard for ML 500, ML 63 AMG)
Third brake light with LEDs
Tyre pressure loss warning system
Windowbags for driver, front passenger and rear passengers

Optional extras

Selection

Safety

Anti-theft alarm system, ATA, with tow-away protection

Bi-xenon headlamps with Active Light System, headlamp cleaning system, dynamic headlamp range adjustment and cornering lights in bumper

Headlamp cleaning system

NECK-PRO active head restraint system, front

PRE-SAFE® system

Sidebags in rear

Comfort and convenience

EASY-PACK load-securing kit with load-securing rails and removable seat cushions

EASY-PACK tailgate, hydraulically operated (can also be closed by pressing button on vehicle key)

Electrically adjustable front seats, with memory function

Heated seats for driver and front passenger

Heated windscreen washer system

KEYLESS-GO

Multicontour seats for driver and front passenger (standard for ML 500)

PARKTRONIC

Rain sensor for windscreen (standard for ML 500)

THERMOTRONIC luxury automatic climate control (standard for ML 500)

Tilting/sliding glass sunroof, electric

Radio/communication

Audio 50 APS radio with CD navigation system

CD changer for 6 CDs, MP3-compatible

COMAND APS control and display system with DVD navigation system and audio CD drive

harman/kardon LOGIC 7® surround sound system with 12 loudspeakers

Design

19-inch AMG light-alloy wheels, 5-spoke design

AMG bodystyling

Dark-tinted glass, rear side windows and rear windscreen

Roof rails/pre-installation for roof-mounted carriers

Wood/leather multifunction steering wheel

Equipment packages

AIRMATIC package

Air suspension, front/rear, with self-levelling control, Adaptive Damping System (ADS).

Chrome package (standard for ML 500)

Door handles in body colour with chrome inlay, side rub strips in body colour with chrome inlay, rear bumper with chrome inlay, black-painted radiator grille with three chrome-trimmed slats, chrome-trimmed scratch protection on rear bumper, chromed stainless steel exhaust tailpipes.

Interior equipment package

Door trim in burr walnut with chrome highlights, leather appointments, electrically adjustable front seats, interior lighting package (door handle illumination, front/rear, tailgate warning light, right, ambient lighting in tailgate, illuminated stowage compartment and illuminated cup holder in front centre console, footwell lighting in rear), tunnel trim in burr walnut, dashboard console in burr walnut.

Off-road styling package

Stainless steel underride guard, front and rear, radiator grille with silver-coloured/chrome finish.

Off-Road Pro engineering package¹

Two-speed transfer case with low-range reduction gearing, automatic or manually selectable multiple-disc lock in transfer case with up to 100% locking effect, manually lockable rear-axle differential with 100% multiple-disc lock, front-axle locking as required with ETS brake intervention, extended adjustment options for air suspension system, reinforced underbody guard, selectable transmission control mode (Standard (S) or Manual (M)).

Sports package

As chrome package, plus: 19-inch light-alloy wheels, radiator grille with silver-coloured/chrome finish, dark-tinted tail lights, blue-tinted windows all round, electrically adjustable sports seats in front, upholstered in Alcantara/ARTICO man-made leather combination with contrasting stitching, sports pedals, interior lighting package (door handle illumination, front/rear, tailgate warning light, right, ambient lighting in tailgate, illuminated stowage compartment in centre console in front, illuminated cup holder in centre console in front, footwell lighting in rear), silver and black aluminium trim (instead of wood in ML 500), silver-painted instrument cluster.

¹Not available for the ML 63 AMG

How do you turn the M-Class into a place in the sun? Just press the button

The M-Class will remember your seat position if you wish. The memory function automatically moves the seats and head restraints into the position you specify. Up to three sets of positions can be programmed in for each of the front seats and called up at the touch of a button.

The COMAND APS control and display system, with DVD navigation system, is an outstanding travelling companion, showing you the way and entertaining you en route with its CD player and radio. If you connect your mobile, using the phone is very straightforward and convenient too. COMAND APS even lets you know your current altitude, the direction of travel in terms of points of the compass and the steering angle.

And if it's more sunshine you're after, we can fit the new M-Class with an electrically operated tilting/sliding sunroof which can be closed using the remote control on the ignition key.







M-Class owners know that there's nothing supernatural about light that shines around corners. If you specify the optional bi-xenon headlamps with Active Light System and dynamic range adjustment, the lights automatically follow the angle of the steering wheel. Depending on the radius of the curve, this improves illumination of the bend by up to 90% - equivalent to an extra 30 to 55 metres.

More light for the interior is also available as an option - with the interior lighting package (part of the interior equipment package and the sports package). Door handle illumination in the front and rear, ambient lighting in the tailgate, an illuminated stowage compartment in the front centre console, an illuminated cup holder and rear footwell lighting are all part of the package



The ML 280 CDI, the ML 320 CDI and the ML 350 are fitted as standard with 17-inch, 7-spoke light-alloy wheels (see page 48), while the ML 500 features 18-inch, 5-spoke light-alloy wheels (top right) as standard. As an option all models can be fitted with 18-inch 5-twin-spoke light-alloy wheels (bottom right). The M-Class can be given a particularly sporty look with the 19-inch 5-spoke light-alloy wheels which form part of the optional sports package (far right)





Off to explore the great outdoors? The new M-Class offers the perfect way to reach the most attractive mountain biking routes.

New Alustyle basic carrier bars (which can only be fitted in conjunction with roof rails) and the New Alustyle bicycle rack from the Mercedes-Benz accessories range allow you to take up to three cycles with you (maximum frame diameter: 82 mm). When you aren't using the bicycle rack, its support frame can simply be folded down, reducing drag and lowering fuel consumption





Travel in style – with Mercedes-Benz accessories for the M-Class. The range includes exclusive incenio designer wheels, such as the 18-inch 5-spoke Mintaka or 19-inch Rukbat in the even sportier 6-spoke design. Another product with an elegant design is the roof box XL made from high-quality, extremely durable materials. It is available in a choice of colours – titanium metallic or matt silver – and with the opening on the right or left. Its sophisticated aerodynamics help minimise noise levels when travelling at speed and keep fuel consumption low



Paintwork and upholstery – the combination options

	<i>TWIN Leather</i>	<i>Leather/ARTICO</i>	<i>man-made leather</i>		<i>Leather</i>		<i>ARTICO man-made</i>		<i>Leather/Alcantara</i>		<i>Nappa leather</i>			
	black	cashmere beige	alpaca grey		black	cashmere beige	alpaca grey		black	alpaca grey	black	cashmere beige	alpaca grey	
<i>Non-metallic paint</i>														
black	●	●	●		●	●	●		●	●		●	●	
alabaster white	●	○	●		●	○	●		●	●		●	○	●
<i>Metallic paint</i>														
obsidian black	●	●	●		●	●	●		●	●		●	●	●
tanzanite blue	●	○	●		●	○	●		●	●		●	○	●
carneol red	●	●	●		●	●	●		●	●		●	●	●
travertine beige	●	●	△		●	●	△		●	△		●	●	△
cubanite silver	●	△	●		●	△	●		●	●		●	△	●
iridium silver	●	○	●		●	○	●		●	●		●	○	●
andradite green	●	●	○		●	●	○		●	○		●	●	○
<i>Special metallic paint</i>														
lazurite blue	●	△	●		●	△	●		●	●		●	△	●
peridot brown ²	●	●	○		●	●	○		●	○		●	●	○

● Recommended ○ Possible △ Not recommended

¹Available from 2nd quarter of 2006

²Available from 3rd quarter of 2006

Non-metallic paint



040 black

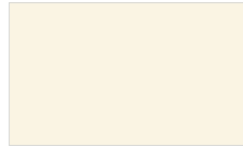

960 alabaster white

Metallic paint
optional extra



197 obsidian black



359 tanzanite blue



544 carneol red



693 travertine beige



723 cubanite silver



775 iridium silver



816 andradite green

Special metallic paint
optional extra



349 lazurite blue

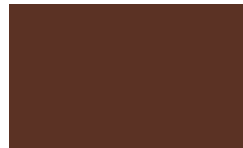

474 peridot brown¹

¹ Available from 3rd quarter of 2006

Tougher clearcoat

This clearcoat is significantly more scratch-resistant than conventional paint and is characterised by a more durable sheen which is noticeably more intense. The secret of this protective coat is to be found in the countless tiny ceramic particles (each less than one millionth of a millimetre in size) which are integrated in the paint binding agent. Both non-metallic and metallic paint finishes benefit from the more scratch-resistant clearcoat which makes them less susceptible to the effects of the weather and environmental conditions such as precipitation, sunlight, temperature variations, dust and soot

TWIN Leather
Leather/ARTICO
man-made leather
optional extra,
standard for ML 500

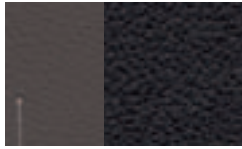

101 black



104 cashmere beige



108 alpaca grey

Leather
optional extra

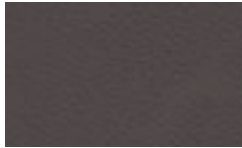

201 black



204 cashmere beige



208 alpaca grey

ARTICO man-made
leather/Aspen
fabric

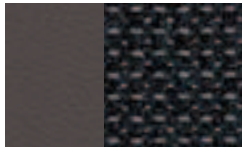

001 black



008 alpaca grey

ARTICO man-made
leather/Alcantara
optional extra,
only in conjunction
with sports package



901 black



908 alpaca grey

Nappa leather
ML 63 AMG



501 black



504 cashmere beige



508 alpaca grey

Aluminium trim

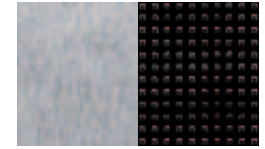

silver/black

Wood trim



burr walnut

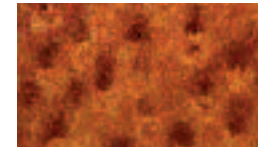

bird's-eye poplar





Technical data

	<i>ML 280 CDI</i>	<i>ML 320 CDI</i>	<i>ML 350</i>	<i>ML 500</i>	<i>ML 63 AMG¹</i>
No. of cylinders/arrangement	6/V	6/V	6/V	8/V	8/V
Bore/stroke (mm)	83.0/92.0	83.0/92.0	92.9/86.0	97.0/84.0	102.2/94.6
Total displacement (cc)	2987	2987	3498	4966	6208
Rated output ² (kW at rpm)	140/4000	165/3800	200/6000	225/5600	375/6800
Rated torque ² (Nm at rpm)	440/1400–2800	510/1600–2800	350/2400–5000	460/2700–4750	630/5200
Compression ratio	18.0	18.0	10.7	10.0	11.3
Top speed, approx. (km/h)	205	215	225	240	250 ³
Acceleration from 0 to 100 km/h (s)	9.8	8.6	8.4	6.9	5.0
Tyre size	235/65 R 17	235/65 R 17	235/65 R 17	255/55 R 18	295/45 R 19
Fuel	Diesel	Diesel	Premium	Premium	Super Plus
Fuel consumption ⁴ (l/100km)					
urban	12.7–12.9	12.7–12.9	15.2–15.4	18.6	– ⁵
extra-urban	7.5–8.0	7.5–8.0	9.4–9.6	10.4	– ⁵
combined	9.4–9.8	9.4–9.8	11.5–11.7	13.4	– ⁵
CO ₂ emissions ⁴ (g/km), combined	249–260	249–260	275–279	319	– ⁵
Tank capacity (l)/including reserve, approx.	95/13	95/13	95/13	95/13	95/13
Turning circle diameter (m)	11.6	11.6	11.6	11.6	11.6

¹Available from 2nd quarter of 2006

²Figures according to Directive 80/1269/EEC in the currently applicable version

³Electronically governed

⁴The figures shown were obtained in accordance with the prescribed measuring process (Directive 80/1268/EEC in the currently applicable version).

The figures are not based on an individual vehicle and do not constitute part of the product offer; they are provided solely for purposes of comparison between different vehicle models

⁵Figures not available at time of going to press

	<i>ML 280 CDI</i>	<i>ML 320 CDI</i>	<i>ML 350</i>	<i>ML 500</i>	<i>ML 63 AMG¹</i>
Kerb weight ² (kg)	2185	2185	2135	2175	2310
Permissible gross vehicle weight (kg)	2830	2830	2830	2830	2880
Perm. towing capacity ³ (kg)					
braked/unbraked	3500/750	3500/750	3500/750	3500/750	3500/750
Load capacity (litres, in accordance with VDA)					
max. behind 2 nd row of seats	833	833	833	833	833
max. behind 1 st row of seats	2050	2050	2050	2050	2050
4 x 4					
Fording depth, standard susp./Off-Road Pro eng. package (mm)	500/600	500/600	500/600	500/600	490/-
Angle of approach/departure ⁴	27°/26°	27°/26°	27°/26°	27°/26°	24°/26°
Minimum ground clearance, front/rear ⁴ (mm)					
standard suspension	210/223	210/223	210/223	210/223	153-234/162-242
with Off-Road Pro engineering package ⁵	166-291/174-299	166-291/174-299	166-291/174-299	166-291/174-299	-
Climbing ability ^{4,6}	100 %	100 %	100 %	100 %	100 %
Low-range off-road ratio (with Off-Road Pro eng. package only)	2.93 : 1	2.93 : 1	2.93 : 1	2.93 : 1	-
Power distribution of permanent all-wheel drive	50 : 50	50 : 50	50 : 50	50 : 50	40 : 60

¹Available from 2nd quarter of 2006

²Figures according to Directive 92/21/EC, version 95/48/EC (kerb weight with fuel tank 90 % full, driver, 68 kg, and luggage, 7 kg) for standard-specification vehicles.

Optional extras and accessories will generally increase this figure and reduce the payload capacity accordingly

³Including drawbar load of 140 kg

⁴Figures according to Directive 70/156/EEC, version 2000/40/EC

⁵Basic setting front/rear (mm): 181/189

⁶Minimum 60 % (= 31°), depending on surface and traction levels



Off-Road Pro engineering package

The Off-Road Pro engineering package extends the off-road capabilities of the M-Class. A two-speed transfer case allows drivers to choose between the 1:1 on-road ratio and the 2.93:1 off-road ratio by pressing the Low Range button in the centre console. This improves grip on loose surfaces by increasing drive torque. An AIRMATIC air suspension which has been specially tuned for off-road driving enables the vehicle's ride height to be raised in three levels, by 30, 80 and 110 millimetres respectively. Manually selectable inter-axle and rear-axle differential locks are also incorporated to maximise traction in tough terrain. The inter-axle lock may also be set for automatic regulation.

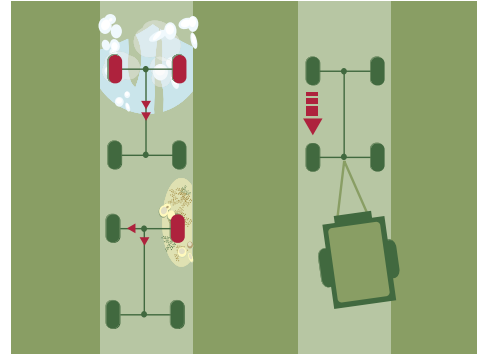

Electronic Traction System (ETS) with ESP® trailer stabilisation

The permanent all-wheel-drive system fitted in the M-Class is partnered by texte nicht up dated.

the ESP®/4ETS electronic dynamic handling control system. Featuring the anti-lock braking system (ABS), acceleration skid control (ASR) and active yaw control, 4ETS permits optimum distribution of the tractive force between the four drive wheels, which in turn enhances traction, particularly in the face of varying surface conditions. Whenever the Offroad switch in the centre console is pressed, ESP®/4ETS primes virtually all system functions for off-road driving. In critical situations ESP® trailer stabilisation brakes the towing vehicle

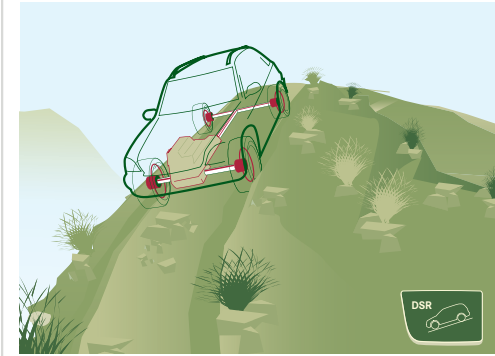

Downhill Speed Regulation (DSR)

When negotiating steep downhill descents in off-road terrain, Downhill Speed Regulation (DSR) ensures that the preset speed is not exceeded. The system is activated by pressing the DSR button in the centre console. Any speed between 4 and 18 km/h can be preset using the cruise control lever. The exact speed is maintained by a combination of engine and transmission control, together with carefully metered brake applications.



AIRMATIC package

The AIRMATIC air suspension system comes with all-round self-levelling control. Consequently, the full extent of the springs' travel is available even when the vehicle is fully laden. Adjustable air bellows automatically lower the ride height to reduce drag at high speeds. This has the additional effect of reducing fuel consumption. Conversely, ground clearance may also be increased when driving over rough terrain. Tyre-related noise levels and ride quality are improved by the ADS Adaptive Damping System (part of the AIRMATIC package), as is directional stability. The three ADS modes "Auto", "Sport" and "Comfort" give the driver additional scope for control over the ride-height settings.

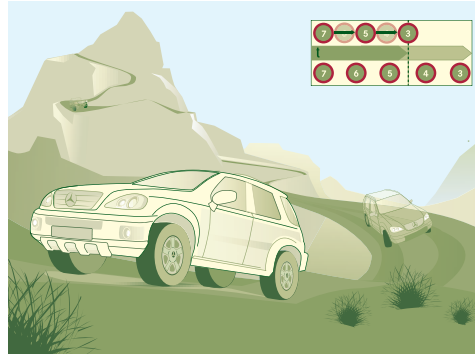

7G-TRONIC

The 7G-TRONIC automatic transmission is the world's first ever 7-speed planetary transmission. It selects the ideal gear to suit the current driving situation at all times, thereby maximising the pulling power. Seven forwards gears and extremely short shift times make for virtually imperceptible gear changes. 7G-TRONIC is also capable of skipping several gears at once when changing gear. Its efficiency cuts fuel consumption by up to 10%.

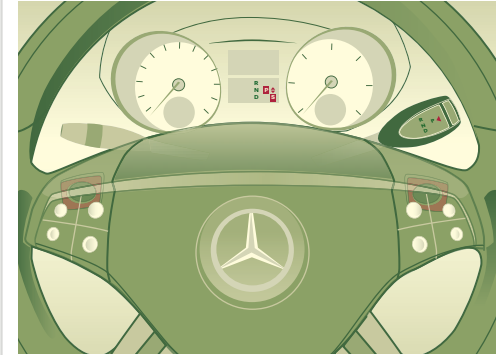

DIRECT SELECT

The M-Class comes with the 7G-TRONIC automatic transmission as standard, which is operated using the DIRECT SELECT lever on the steering column that replaces the conventional automatic selector lever in the centre console. Drivers with a taste for an even sportier style of motoring have the option of shifting down manually using the DIRECT SELECT gearshift buttons on the rear of the steering wheel's spokes. The current shift range is displayed in the instrument cluster.



KEYLESS-GO

If you are carrying KEYLESS-GO, the electronic key, with you, all you need to do is pull the door handle gently to unlock the door. The secret to this lies in radio-frequency communication between the KEYLESS-GO key and the vehicle electronics. With KEYLESS-GO the engine can also be turned on and off using a button, which is fitted in place of the conventional ignition.

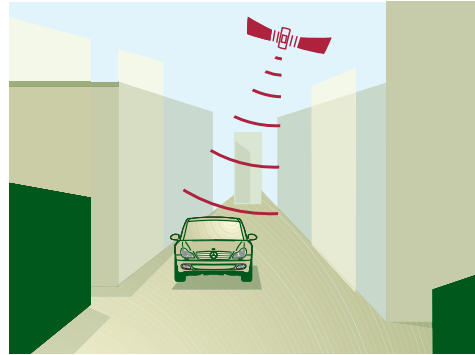

COMAND APS

COMAND APS's integral DVD navigation system has a significantly larger memory in the new M-Class. This means that once your route has been calculated, the navigation DVD can be removed and the player used for audio CDs. If you opt to do this, navigation will continue in the form of arrow icons rather than the usual map display. The off-road "Compass" menu is available for the M-Class in conjunction with COMAND. Specific off-road information is shown in the display, including a compass indicating your current course, an altimeter showing the current altitude and an icon indicating the steering angle.

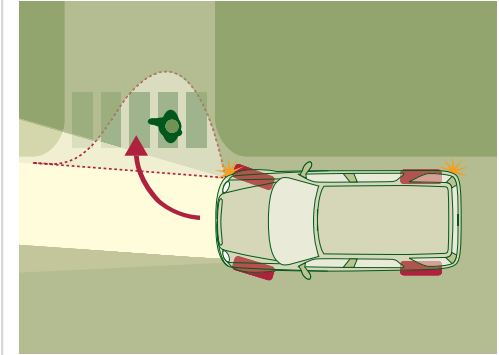

Cornering light function

The cornering light function is part of the bi-xenon headlamp option. By using the wider light beam from the front fog lamps, the cornering light function provides significantly improved illumination of the road or entrance into which the vehicle is turning. The left or right front fog lamp is switched on when the headlights are on, the vehicle speed is less than 40 km/h and the indicators are operated or a given steering angle is applied. As a result, pedestrians and potential obstacles can be identified at an early stage and accidents avoided.

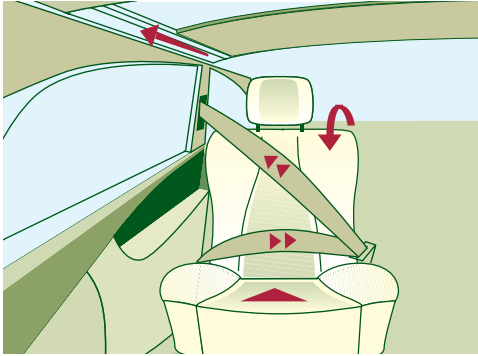

PRE-SAFE®

The PRE-SAFE® safety concept is designed to detect critical situations and trigger preventive measures to protect the vehicle occupants. PRE-SAFE® is activated in an emergency braking situation along with Brake Assist (BAS), for example, or in the event of a skid caused by serious oversteer or understeer. When PRE-SAFE® is triggered, the driver and front passenger seat belts are tightened by electrically operated, reversible belt tensioners as a precaution. The front passenger seat moves into a safety position (only in conjunction with optional memory function). The sliding sunroof also closes if the vehicle begins to skid.

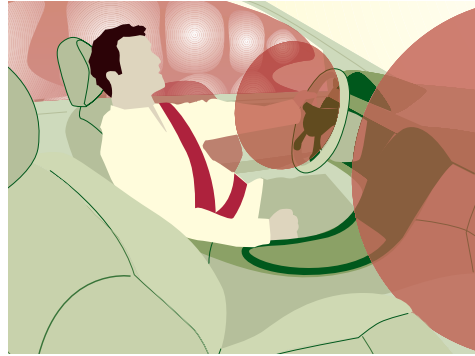

Airbags and belt system

The M-Class is fitted with selective front airbags plus sidebags and windowbags, all of which are activated in accordance with the type and severity of a collision. In the event of a frontal collision the electronics deploy either just one or both stages of the front airbags, depending on the severity of the accident, offering the front occupants an appropriate level of protection. The sidebags provide increased protection for the chest area, while the windowbags offer protection for the head, expanding like a curtain between the A and C-pillars. Belt tensioners on the front and on the outer rear seats pull the belts taut against the body in fractions of a second in the event of a frontal or rear-end collision of a specific severity.

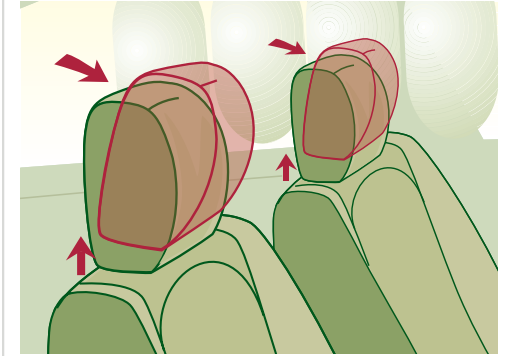

NECK-PRO

The new NECK-PRO head restraint system for the driver and front passenger responds rapidly to support the head in the event of a rear-end collision. Sensors trigger pre-tensioned springs, causing the head restraints to move forward by 44 mm and up by 30 mm. NECK-PRO therefore helps to minimise the risk of whiplash injuries in this type of collision. Once triggered, the head restraints can be returned to their original position manually.

Our service is your gateway
to the world



www.mercedes-benz.com

Step into the world of Mercedes-Benz on-line and find out more about the brand – from its history, in our virtual museum, to the company’s latest innovations, including recent developments in trailblazing fuel cell technology. Our extensive technology glossary will bring you up to speed with all the latest terminology. You can click through our various model series from A to V and check out special articles on each model. And the dealer listings show you where to find your nearest Mercedes-Benz dealer. Cars and culture? Mercedes-Benz is well-known for its sponsorship programmes, so it’s natural that we also provide you with up-to-the-minute information on motor shows, exhibitions and sports events. There is also information about driving

safety training events designed to let you test your driving skills. Have we awakened your interest in motorsport? Formula One? You can find all the latest results and news on-line, and even order tickets. And of course we haven’t forgotten the children. In Cedy’s World there are games, a forum where your children can meet others and plenty of opportunities to learn all about cars, technology and road safety. As you can see, the virtual world can be as exciting as the real one.

MobiloLife

With MobiloLife, our mobility and warranty package, you can expect years and years of carefree driving. Whether you have lost your key, are having problems starting the car or your car has broken down and cannot be repaired immediately, the mobility package ensures that you still reach your destination, throughout nearly the whole of Europe. Under certain circumstances we will even meet the cost of an airline ticket. And if help takes longer than expected, we will put you up in a hotel of your choice. But don't get too excited – after all it's very rare for a Mercedes to break down. Just call Mercedes-Benz on 008001777 7777 from almost any European terrestrial or mobile network and our Service 24h team will assist you in your own language.

Our staff are there for you around the clock, 365 days a year. Your vehicle documents provide details of the respective alternative phone numbers for each country. MobiloLife will also help if you bring your car in for more serious warranty or policy repairs. MobiloLife applies to each new car for a period of two years. It is then automatically renewed every time your vehicle is serviced at a Mercedes-Benz service centre and remains valid until the next service is due – for up to 30 years. Our service even includes a warranty against rusting through from the inside. For more detailed information on MobiloLife, see your vehicle documents.

MercedesCard

There's also a wealth of experiences to enjoy when you're not sitting at the wheel of your Mercedes. Owning a MercedesCard is all it takes. It acts as your ticket to the world of Mercedes-Benz and doubles as a practical credit card. The MercedesCard Journal contains details of a selection of sporting, cultural and travel events, put together especially for you. For further information call 00800 – 6200 3190 in Germany, 0800 – 55 79 84 in Switzerland or 0800 – 20 65 65 in Austria.

DaimlerChrysler Bank – financial services

If you have already set your heart on your dream Mercedes and want to remain flexible in financial terms, our leasing, financing and insurance packages could be exactly what you're looking for. The on-line calculator allows you to work out your monthly payments for yourself. In addition to individually geared financial services, we can also offer you tailor-made investment products. For further information, call 01803 – DC Bank from inside Germany (01803 - 32 22 65, 9 ct per minute) or visit www.daimlerchrysler-bank.com

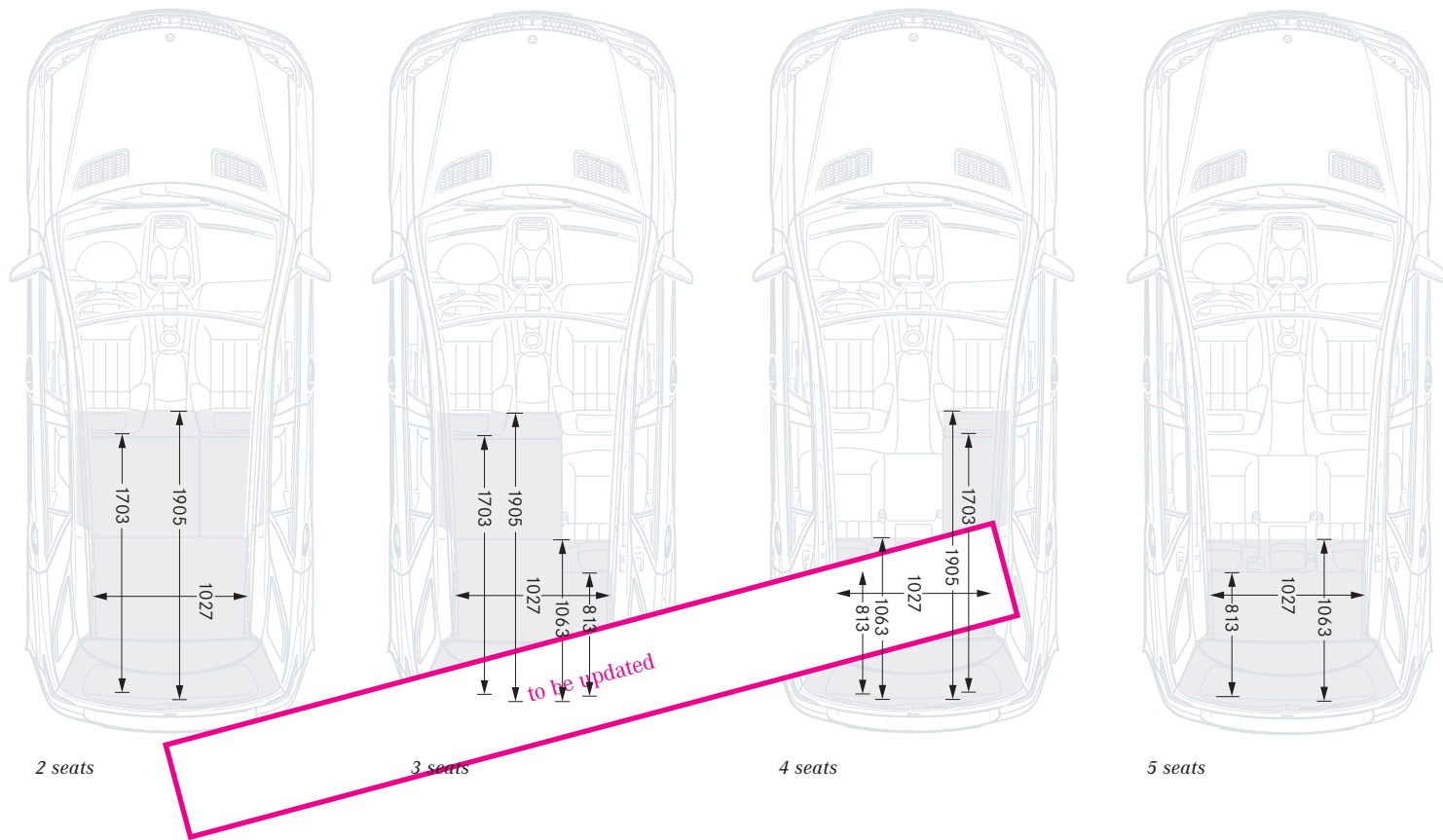

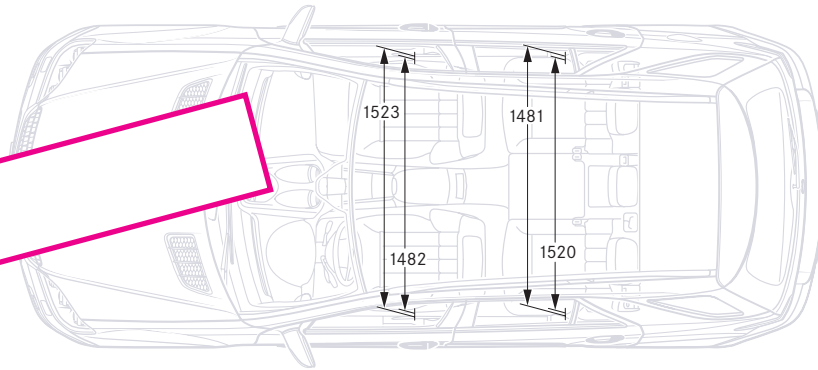
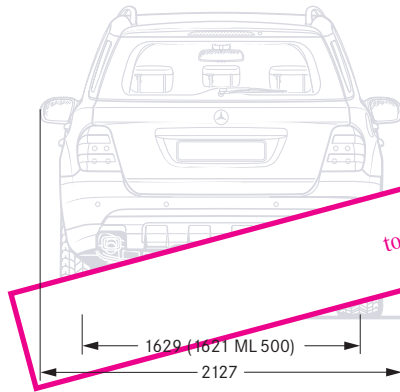
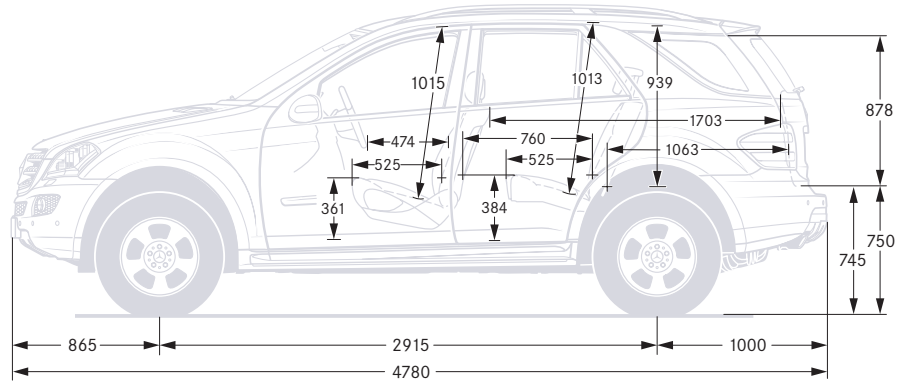
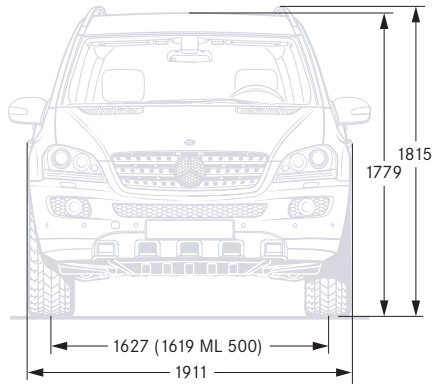

to be updated

The dimensions shown are average values (in mm) and apply to the unladen, standard-specification vehicle



Desierto de Atacama

Known as the world's most arid desert, the Atacama features spectacular volcanic landscapes and endless salt basins which allow virtually no vegetation. There are areas here where rain has never been recorded. The desert, in the north of Chile, is flanked by the cold Pacific on one side and the snow-capped Andes on the other. After a long journey through extraordinary scenery, reminiscent of a Dalí painting, you reach the heart of the region: San Pedro de Atacama, a busy oasis of low adobe huts and three narrow, dusty streets, centred around a small yet charming plaza.



Géiseres del Tatio

4300 m above sea level, "El Tatio" is the world's highest geyser field. This spectacular natural phenomenon at the foot of Volcán Tatio, in the north of the Atacama Desert, is all the more impressive as dawn breaks on a wintry day and temperatures are around 20 degrees below zero. The sight of the clouds of steam, which reach a height of up to 10 m, makes it well worth braving the ascent and the thin air. Although virtually all of Chile's volcanoes are now extinct, the sound of the seething water hints at the extraordinary forces still at work below the lunar landscape here.



Lago Miscanti

150 km from San Pedro de Atacama, high up in the Andes at an altitude of 4000 m, lies one of nature's miracles – Lake Miscanti. It is tucked away in the vast volcanic landscape of the Reserva Nacional Los Flamencos national park – so called because of the flamingos which flock to this crystal-clear lake.

Thanks to the rain-free weather conditions, numerous prehistoric Inca tools have been discovered in the Atacama Desert, and dotted about the landscape, piles of stones can be found which the Incas once used as path-markers.



Estación Mapocho

Up until 1987 this building, with its striking masonry, was a bustling station, where trains departed for Valparaíso and for the Argentinian city of Mendoza. It was built directly alongside the Mapocho river in 1905, to a design by the architect Emilio Jequier.

The conquistador Pedro de Valdivia reached the Mapocho valley in 1540 and founded Santiago. The later construction of dams and the railway allowed the town to expand rapidly. Today Mapocho station is Santiago de Chile's most important cultural centre and stages theatrical performances and a variety of exhibitions.



Valparaíso

Around 100 km north-west of Santiago de Chile is Valparaíso – the “Valley of Paradise”. Why the name? One glance from the harbourfront restaurant at the ships and the seemingly endless coastline should give you some idea.

Valparaíso is one of the oldest towns in Chile. It was here that the first funiculars – the “ascensores” – were built. They still serve today as a means of transportation to the raised terraces, lined with grand villas. But the town’s little weathered huts, too, add their own charm to the wonderfully nostalgic flair of this place, a flair that is perhaps at its strongest when dense mist hangs over the bright, colourful houses in the early morning. The enchanting aspects of the town don’t stop there, though, for in Valparaíso, it is said, live the women with the most beautiful legs of all.



Patagonia

The Magellan region is the heart of Patagonia. Impressive torrents of ice-cold glacial water alternate with lush, green mountain slopes. An absolute must for every visitor is Torres del Paine, one of the country’s most spectacular national parks and home to countless species of flora and fauna. The condor, a bird with a wingspan of up to 3 m, can be seen circling overhead here, except when it pauses to settle, majestically, on the back of a guanaco.

The nearest settlement is Puerto Natales – a quiet little port, which makes its living from fishing and petroleum production. Along with Punta Arenas, it is one of the southernmost towns in Chile.



Lago Pehoé, Patagonia

The breathtaking mountain landscape of Torres del Paine is characterised by 2600-m high granite pillars known as “Los Cuernos” (the horns). Dense forest and shimmering turquoise lakes make this area a paradise for hikers. To the west of Lago Pehoé you can make a memorable crossing to the ice-blue glaciers on Lago Grey. In contrast to the dry north and the Mediterranean climate in the heart of Chile, the weather here, near the Antarctic, can be stormy, snowy and very wet.



Cueva del Milodón

The ‘Cave of the Milodón’ lies at the foot of Mount Benítez in the Magellan region of southern Chile. It was here, in 1896, that Hermann Eberhard discovered the well-preserved remains of a unique animal – the ‘milodón’, a herbivorous mammal which was twice as big as an adult human. The remains are kept in a small local museum, and a breathtaking replica of the animal, which was similar to a bear and is depicted standing upright, can be seen at the entrance to the cave. Signs of early human settlement have been found in this area too and have led to the assumption that the 30-m high cave was used as a shelter over 12,000 years ago.





Take-back of end-of-life vehicles. Coming full circle

At the end of its long life, you can return your M-Class to us for environment-friendly disposal in accordance with the EC End-of-Life Vehicle Directive.¹
But that day lies a long way off.

¹Applies in accordance with national regulations to vehicles up to 3.5 t permissible gross weight. The M-Class has met the statutory regulations governing the suitability of the vehicle's design for reuse and recycling for a number of years now. A network of vehicle take-back depots and dismantlers has been established which will process your vehicle in an environment-friendly manner. The ways in which both vehicles and parts can be recovered are subject to ongoing development and improvement. Consequently, the M-Class will be able to comply with any future increases in the recycling quota within the stipulated time limits.

For further information, please call 00800 1 777 7777.

Please note: changes may have been made to the product since this brochure went to press (15.09.2005). The manufacturer reserves the right to make changes to the design, form, colour and specification during the delivery period, provided these changes, while taking into account the interests of the vendor, can be deemed reasonable with respect to the purchaser. Where the vendor or the manufacturer uses symbols or numbers to describe an order or the subject of an order, no rights may be derived solely from these. The illustrations may show accessories and items of optional equipment which are not part of standard specification. Colours may differ slightly from those shown in the brochure, owing to the limitations of the printing process. This brochure has been compiled by DaimlerChrysler AG of Germany and is distributed internationally.

It provides a general indication of the range of models, features, optional extras and/or colours available in various countries.

Some of the models, features, optional extras and/or colours shown may not be available in your country or may only be available in a different specification.

Additionally some models, features, optional extras and/or colours may only be available in combination with others.

For current and more specific information in relation to the range of models, features, optional extras and/or colours available in your country, and their pricing, you should contact your nearest authorised Mercedes-Benz Passenger Car Dealer.