

This brochure has been compiled by DaimlerChrysler AG of Germany and is distributed internationally. It provides a general indication of the range of models, features, optional extras and/or colours available in various countries. Some of the models, features, optional extras and/or colours shown may not be available in your country or may only be available in a different specification. Additionally some models, features, optional extras and/or colours may only be available in combination with others. For current and more specific information in relation to the range of models, features, optional extras and/or colours available in your country, and their pricing, you should contact your nearest authorised Mercedes-Benz Passenger Car Dealer.





THE CLS-CLASS



Mercedes-Benz

THE CLS-CLASS



Its stylish lines all converge on one point: your heart











## Contents

08	Design
12	Driving dynamics
16	The CLS 320 CDI and the CLS 350
18	The CLS 500
22	Engines and technology
24	The CLS 55 AMG
28	designo
32	Comfort
34	Safety
36	Seeing and being seen
38	Equipment
48	Accessories and the Mercedes-Benz Collection
50	Paintwork and upholstery
57	Technical data
58	Dimensions
62	Glossary
68	Service







The technology of seduction

## Coupé elegance to the power of four. Your eyes are not deceiving you

We may not realise it, but every new encounter begins with a moment of eye contact which allows us to gauge whether we are attracted to the newcomer. Even more remarkable is the fact that the first three seconds are decisive. So let's see that first meeting with the CLS again in slow motion. Second 1: the curved L-shaped headlamps of the new Mercedes face sparkle at you seductively. Second 2: refusing to give way easily, you cast your gaze across the rest of the CLS and are struck by the contrast between the restrained sides and the dynamic curve of the arching roof. Second 3: you take a step backwards and can hardly believe your eyes. This car is an extraordinarily attractive combination of a coupé and a four-door saloon – a synthesis of sportiness and comfort. Second 4: the CLS-Class has won. You get in.







Body language.

Feelings speak louder than words

#### Experience sheer driving pleasure

Picture a long straight road. Heading along it – the CLS – elegant and dynamic. And best of all, you are at the wheel. In this four-door Coupé, every trip becomes a real pleasure, whatever the distance. The optional AIRMATIC DC system (standard in the CLS 500 and CLS 55 AMG) ensures that the CLS glides gently over any bumps in the road.

Your destination draws closer with every gearchange.

The 7G-TRONIC seven-speed automatic transmission in the CLS 320 CDI, CLS 350 and CLS 500 shifts particularly smoothly while the AMG SPEEDSHIFT 5-speed automatic transmission in the CLS 55 AMG offers even sportier gearchanges thanks to shift buttons on the steering wheel.

The optional, electrically adjustable multicontour luxury seats for the driver and front passenger (standard in the CLS 55 AMG) provide even better lateral support for sporty driving. Optimised for the individual occupant, they prevent muscular tension from developing, even on long journeys – a particularly valuable feature if you can't bear the thought of having to get out of the CLS again.













S 0C 7661





## It's only natural to gravitate towards a heavenly body

### **The CLS 320 CDI and the CLS 350. Resistance is futile**

It's not just the beautiful and stylish exterior that gives this exclusive coupé its magnetic appeal. The CLS 320 CDI and the CLS 350 have many other qualities, too.

Such as inner strength: the V6 engines with four valves per cylinder put an enormous amount of power and torque on tap over a wide engine speed range.

All this potential is handled by the 7G-TRONIC seven-speed automatic transmission which makes shift operations smoother, delivers quicker intermediate sprints when accelerating and features a multiple downshift function which allows it to skip individual gears, thereby reducing fuel consumption and emission levels.

The generous personality of the CLS 350 is reflected by its 17-inch light-alloy wheels with their attractive 5-twin-spoke design, the speed-sensitive power steering and the THERMATIC automatic climate control system.

But this is a coupé which is generous on space, too: with its luggage compartment volume of some 500 litres, it is ready to take on board everything you need for your trip.



## If passion is a place, you've just arrived

### Welcome to the CLS 500

What thoughts does the concept of passion bring to mind? Everyone has their own ideas, of course, but there is one common denominator: passion is always about excitement. And so, too, is the CLS 500. At its heart is a technological tour de force in the form of a powerful V8 engine whose performance credentials are underlined by its superb sound. At the same time, the 18-inch light-alloy wheels with their 5-spoke design ensure a lasting visual impact.

As for driving pleasure, you'll find that the CLS 500 offers a wealth of high-tech features as standard: speed-sensitive power steering, the superbly comfortable AIRMATIC DC air suspension system, the innovative 7G-TRONIC seven-speed automatic transmission and the electrohydraulic braking system all go into the equation. What comes out is a highly satisfying drive.











### **Seats of learning**

Ergonomically formed for optimum comfort and support, the seats in the CLS-Class help you make the most of its sporty credentials. And because no two people have exactly the same build, the front seats are equipped with a 4-way electric adjustment system which allows them to be configured to provide the ideal position, cushion height, cushion inclination and longitudinal setting for each occupant.

### **Intelligent protection**

The crash-responsive NECK-PRO head restraints for the driver and front passenger reduce the load on the vertebrae of the neck. In a rear-end collision sensors cause them to be moved forwards and upwards – the sudden rearward movement of the head is considerably reduced. These head restraints come as standard in the CLS-Class.

### **First-class cabin**

The CLS 500 is equipped as standard with leather appointments including a leather steering wheel with a matching leather selector lever. These are complemented to perfection by the fine wood trim on the elegant, curved dashboard.







#### **Powerplants with relaxing properties**

The 6-cylinder common-rail diesel engine in the CLS 320 CDI makes every drive an enjoyable journey. A whole array of new features, such as the leading-edge piezo injectors, ensure among other things that the fuel is metered with ultra-high precision and that the injection timing is extremely accurate. Improved air ducting has enhanced the engine's smoothness still further. Moreover it meets the EU4 exhaust emissions standard by a considerable margin, and the standard-fitted diesel particulate filter eliminates about 95 % of the particulates from the exhaust.

The responsive V6 unit in the CLS 350 has an even power delivery over a wide engine speed range and accelerates the vehicle from 0 to 100 km/h in around 7 seconds. The CLS 320 CDI, by the way, displays the same impressive acceleration.

The V8 engine in the CLS 500 impresses with its even-running characteristics and dynamic power output. Its three valves per cylinder make room in the combustion chamber for two spark plugs, which ignite in phased operation according to the load and driving style. This results in more intensive fuel combustion, giving better consumption figures with lower emissions.





## The best way to attract attention? Make yourself scarce

**The CLS 55 AMG: out of sight in no time, but never out of mind**  
0 to 100 km/h in just 4.7 seconds. This breathtaking performance is made possible by the impressive technical characteristics of the AMG 5.5-litre V8 supercharged engine with its 350-kW output and its maximum torque of 700 Nm.

The AMG SPEEDSHIFT 5-speed automatic transmission ensures that this formidable power is delivered instantaneously, while steering-wheel gearshift buttons make for even sportier gearchanging. The AMG sports suspension, based on the AIRMATIC DC system, and the AMG high-performance braking system have also been optimised to cope with the vehicle's enhanced dynamics.

But advanced technology is only part of the story. Wherever the CLS 55 AMG appears, its attractive styling – featuring dynamic front and rear aprons, side-skirts, and the radiator grille with its three substantial silver-painted louvres – is a magnet for envious glances.

AMG bodystyling as well as 18 and 19-inch AMG light-alloy wheels can be specified as optional equipment for the other CLS models.

Please see the AMG brochure for full details.





*The rear of the CLS 55 AMG. The two chromed twin tailpipes of the AMG sports exhaust system and the pronounced AMG airflow breakaway edge on the boot lid testify to formidable performance*

*Compulsive viewing: the sportily styled AMG instrument cluster and the ergonomic AMG sports steering wheel with gearshift buttons*

*Fine nappa leather appointments and AMG sports seats with Alcantara inserts make for a particularly stylish and comfortable travelling environment – even in cold weather, thanks to the three-stage front seat heating system*

*Sporty right down to the ground with 18-inch twin-spoke AMG light-alloy wheels*



Give in to temptation.

Who knows when you'll get another opportunity like this?

**Knowing when to give in to your weakness for the finer things in life is a sign of strength**

You never get a second chance to make a first impression, so follow your instincts and give your CLS the external finish and interior appointments you've always dreamed of. For a particularly individual touch, you can choose from the wide range of designo metallic paint finishes and leather colours. Settle back into the comfortable seats upholstered in finest designo leather with decorative double topstitching. Cast your eyes over the roof lining which integrates harmoniously with the overall design concept (a soft Alcantara finish – in anthracite, for example – is available as an option). The designo trim elements in fine wood or stylish black piano lacquer complete a look that virtually transforms the car's interior. But there's no need to worry. It's still a CLS – it's just that now it's more irresistible than ever.











*Look and feel: the CLS dashboard. The deep gloss of the designo black piano lacquer finish lends the trim elements a particularly stylish touch*

*Take your seat. The beautifully crafted seats upholstered in fine designo leather feature distinctive double topstitching, matt chromed designo metal badges and the characteristic six-piece vertical piping design*

*An elegant combination of black leather and fine designo wood or designo black piano lacquer is available for the selector lever when designo trim elements are specified for the vehicle interior*





## Why just drive when you can go by air?

### **AIRMATIC DC. Take off without leaving the ground**

Cobble stones and potholes become no more than a distant memory thanks to the AIRMATIC DC semi-active air suspension system which irons out the irregularities in the road surface. You have a choice of three chassis settings: sports, sports/comfort and comfort.

### **The ideal temperature, whatever the season**

The THERMATIC automatic climate control system, fitted as standard, makes it easy to set the temperature that suits you best. The optional THERMOTRONIC 4-zone automatic climate control system (standard in the CLS 500 and CLS 55 AMG) offers an even higher level of comfort: all the occupants of the vehicle can set their own individual temperature and airflow preferences while a combined dust and activated charcoal filter improves the quality of the intake air. Sensors continuously monitor the interior temperature and insolation level, adapting the blower speed as required.

Additional comfort-oriented optional extras are available to make your time aboard the CLS-Class even more enjoyable, a notable example being PARKTRONIC. This parking and manoeuvring aid gives a warning as soon as an obstacle is detected.





## Safety is far too important to be left to chance

### **Always in control – even in critical situations: the electrohydraulic braking system**

Its great strength is its ability to respond intelligently – especially in tricky situations. This milestone in brake technology works with a combination of hydraulic and electronic components. Able to react more precisely and quickly than conventional brake systems, it can cut stopping distances significantly. Furthermore, it helps optimise other safety functions such as ESP<sup>®</sup>, ASR, ABS and BAS. If an accident should occur, the crash-responsive NECK-PRO head restraints for the driver and front passenger, the front airbags, sidebags and windowbags can be activated selectively in accordance with the type and severity of the impact. In the event of a frontal collision, intelligent sensors determine whether the impact is a minor one or more severe and adjust the inflation rate of the two-stage front airbags accordingly. In a front or rear-end collision which exceeds a specific threshold level, belt tensioners on the front and rear seats instantaneously pull the belts taut against the occupants.













## See things in a new light

### **Turning night into day**

Driving can be relaxing and involving at the same time – if the conditions are right. The lighting technology in the CLS is designed to help create those conditions. Bi-xenon headlamps with the Active Light System and the cornering light function are available as an optional extra. The Active Light System guides the headlamp beam in keeping with the driver's steering movements, the low-beam headlamps thereby improving illumination of curves and bends. The cornering light function is activated automatically while the headlights are on and the vehicle is traveling at speeds up to 40 km/h. It provides additional illumination during cornering and turning manoeuvres by turning on the right or left front fog lamp when a given steering angle is exceeded or when the indicators are operated.

The new type of high-performance light bulb used for the tail lights is filled with xenon gas. These bulbs have a longer service life and consume less electrical power than standard bulbs, while LED technology delivers a faster brake-light response. The headlamps are housed behind scratch-resistant polycarbonate lenses which are lighter than glass and less vulnerable to stone impacts.



*They look good and feel even better: the steering wheel and selector lever in the CLS are finished in exquisite leather as standard. The dashboard is embellished with fine wood elements; the centre console features the Audio 20 radio which comes with a CD drive, RDS tuner, telephone keypad and 10 loudspeakers*

*Practical: Headlamp Assist, ambient lighting and automatically dimming interior and exterior mirrors*





# Standard equipment

## *Selection*

---

3-point seat belts (four), height-adjustable in front, with automatic height adjustment in rear

---

7-speed automatic transmission 7G-TRONIC in the CLS 320 CDI, CLS 350 and CLS 500

---

Aero windscreen wipers with one-touch wiper function, rain sensor with infinitely variable intermittent-mode control

---

Anti-lock braking system (ABS)

---

ASSYST PLUS service interval indicator with service computer

---

Audio 20 CD radio with telephone keypad, 10 loudspeakers, radio aerial integrated in rear windscreen

---

Belt tensioners with adaptive belt force limiters for driver and front passenger, one-stage for rear seats

---

Brake Assist (BAS)

---

Central locking with interior switch and crash sensor

---

Crash-responsive NECK-PRO head restraints for driver and front passenger

---

Cruise control with SPEEDTRONIC variable speed limiter

---

Electrically adjustable front seats

---

Electrohydraulic braking system

---

Electronic immobiliser, incorporating ELCODE locking system, with infrared/radio remote control and visual locking-verification signal

---

---

Electronic Stability Program (ESP®)

---

Head restraints (four), electrically folding in rear

---

Heated exterior mirrors, electrically adjustable, with aspherically curved mirror glass and integral indicator repeaters

---

Heated windscreen washer nozzles

---

Multifunction steering wheel

---

Outside temperature display

---

Power windows (four) with one-touch control and obstruction sensor

---

Rear armrest in appointments colour, with cup holder

---

Seat occupancy sensor in front passenger seat

---

Speed-sensitive power steering with safety steering column

---

Steering column manually adjustable for height and reach

---

THERMATIC automatic climate control in the CLS 320 CDI and CLS 350

---

Tinted glass all round, rear windscreen in single-layer safety glass

---

Two-stage front airbags and sidebags for driver and front passenger, plus windowbags

---

## Welcome to the comfort zone

### **Seduction is the art of continuously surprising the senses**

You feel a sense of overwhelming well-being as you settle into the driver's seat of the CLS? It's only natural. But the rear seats are also extremely inviting. Featuring fine upholstery and offering a generous amount of space, the back is as comfortable as the front.

Stylish and comfortable, the two individual rear seats are extremely accommodating and relaxing to sit in. Although separated by the extended centre console, they allow their occupants a shared sense of enjoyment in the CLS driving experience. Optional leather upholstery – shown here in cashmere beige – entices you to linger and appreciate the superb comfort of the supportive seat structure and head restraints. Generous amounts of legroom add the final relaxing touch. So make the most of your time in the back. Who can tell when you'll get your next chance to sit there?







*Practicality and stylishness are by no means irreconcilable; the control layout is both user-friendly and elegant*

*The optionally available THERMOTRONIC 4-zone luxury automatic climate control maintains a comfortable travelling environment: the required temperature can be set independently for each of the four seats*

*The COMAND APS control and display system (optional) brings multiple functions together in a single unit. COMAND provides a user-friendly control interface to the radio, DVD player and navigation system; it can also be specified to support telephone functionality*



*The selector lever can give you control of more than simply the 7G-TRONIC 7-speed automatic transmission. Opt for KEYLESS-GO and switching the engine of your CLS on and off is as simple as pressing the Start and Stop buttons*

*The optional memory package allows three different users to store their preferred steering-wheel, exterior-mirror and front-seat positions and can recall them as appropriate*







*Design at its finest: the incenio Menket designer wheel from the accessories range in the 7-spoke version exclusive to the CLS. Available in size 245/40 R 18 for the front wheels and 275/35 R 18 for the rear*

*Precious metal: the 5-spoke light-alloy wheel is standard on the CLS 500 and available as an option for the CLS 320 CDI and the CLS 350. Also available for mixed-size tyres – 245/40 R 18 at the front and 275/35 R 18 at the rear*

*Sporty right down to the ground: optional 18-inch multi-spoke light-alloy wheels – 245/40 R 18 at the front and 275/35 R 18 at the rear*



*Hands-on experience: the optional wood/leather version of the multifunction steering wheel keeps you in fingertip control of a whole host of systems aboard the CLS. You can use it to operate the comfort functions provided by the COMAND system while optional shift buttons allow you to change gear. A further option is special sound for a special vehicle: the harman/kardon LOGIC 7® surround sound system. Twelve metal matrix loudspeakers and a 420-Watt DSG amplifier provide the soundtrack to your travels*



## Optional extras

### **Selection**

---

Anti-theft alarm system (ATA) with tow-away protection and interior monitoring

---

Audio 50 APS radio with CD navigation system

---

Auxiliary heating with remote control

---

Bi-xenon headlamps with Active Light System and cornering light function<sup>1</sup>

---

COMAND APS control and display system for radio/navigation

---

DISTRONIC proximity control

---

Dynamic multicontour seats for driver and front passenger

---

Electrically folding exterior mirrors left and right

---

harman/kardon LOGIC 7® surround sound system with 12 high-performance loudspeakers

---

Headlamp cleaning system

---

Heated multifunction leather steering wheel

---

Integral garage door opener in the interior mirror

---

ISOFIX child-seat attachment system

---

---

KEYLESS-GO

---

Luxury front seats, heated and ventilated

---

Memory package for front seats, steering column and exterior mirrors

---

Mercedes-Benz telephone system

---

Metallic paint finish

---

PARKTRONIC

---

Rear sunblind, electrically operated

---

Semi-active air suspension (AIRMATIC Dual Control) for the CLS 320 CDI and the CLS 350

---

Ski bag

---

THERMOTRONIC 4-zone automatic climate control in the CLS 320 CDI and the CLS 350

---

Tilting/sliding glass sunroof, electrically operated

---

Tyre pressure monitoring system

---

Wood/leather multifunction steering wheel

---

<sup>1</sup>Cornering light function not available for the CLS 55 AMG



**Let the winter games begin!**

Driving to the slopes is now even more fun than slaloming down them. And thanks to the New Alustyle ski and snowboard rack, you can transport your winter sports equipment safely and conveniently. The standard version is designed to hold up to 4 pairs of skis or 2 snowboards while the luxury version can accommodate up to six pairs of skis or 4 snowboards.

**Summer's in the bag!**

A highly practical solution for your holiday luggage: available as an accessory, this high-quality travel bag with trolley function is particularly spacious and well thought-out. The shoulder strap is removable. Have a good trip!



*The KID child seat with integral padded play table offers a high level of safety for children from 3½ to 12 years of age. The side belt guides ensure that the seat belt does not ride up on to the child's abdomen. Optionally, the front passenger seat can be fitted with an automatic child-seat recognition function which detects Mercedes-Benz-approved child seats fitted with a transponder*

*Mounted under the parcel shelf, this drawer keeps small objects out of sight*

*The Mercedes-Benz lettering in the high-gloss polished chromed door-sill panel is illuminated every time the door is opened*

*All accessories are available on request*



## Paintwork and upholstery – combination options

	<i>Fabric/leather "Biarritz"</i> black	<i>Leather<sup>1</sup></i> black	cashmere beige	sunset red	basalt grey	<i>Nappa leather</i> black	cashmere beige	sunset red	basalt grey
<i>Non-metallic finishes</i>									
black	<input type="checkbox"/>	●	●	●	●	●	●	●	●
alabaster white	<input type="checkbox"/>	●	○	○	●	●	○	○	●
<i>Metallic finishes</i>									
green black	<input type="checkbox"/>	●	●	△	●	●	●	△	●
obsidian black	<input type="checkbox"/>	●	●	●	●	●	●	●	●
tanzanite blue	<input type="checkbox"/>	●	○	△	●	●	○	△	●
carneol red	<input type="checkbox"/>	●	●	△	○	●	●	△	○
travertine beige	<input type="checkbox"/>	●	●	○	△	●	●	○	△
cubanite silver	<input type="checkbox"/>	●	△	●	△	●	△	●	△
perlite grey	<input type="checkbox"/>	●	△	△	●	●	△	△	●
iridium silver	<input type="checkbox"/>	●	○	●	●	●	○	●	●
andradite green	<input type="checkbox"/>	●	●	△	○	●	●	△	○
indium grey	<input type="checkbox"/>	●	●	△	△	●	●	△	△

□ Standard ● Recommended ○ Possible △ Not recommended

<sup>1</sup>Standard in CLS 500



**Non-metallic  
paint**



*040 black*

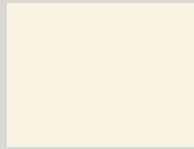

*960 alabaster white*

**Metallic paint**  
*optional extra*



*189 green black*



*197 obsidian black*



*359 tanzanite blue*



*544 carneol red*

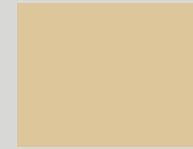

*693 travertine beige*



*723 cubanite silver*



*747 perlite grey*

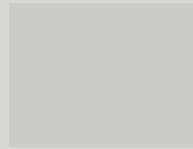

*775 iridium silver*



*816 andradite green*

**Special paint**  
*metallic*



*963 indium grey*

**Tougher clearcoat**

This clearcoat is significantly more scratch-resistant than conventional paint and is characterised by a more durable sheen which is noticeably more intense. The secret of this protective coat lies in the countless tiny ceramic particles (each less than one millionth of a millimetre in size) which are integrated in the paint binding agent. Both non-metallic and metallic paint finishes benefit from the more scratch-resistant clearcoat which makes them less susceptible to the effects of the weather and environmental conditions such as precipitation, sunlight, temperature variations, dust and soot.

Actual colours may differ slightly from those shown owing to the limitations of the printing process

Fabric/leather  
"Biarritz"

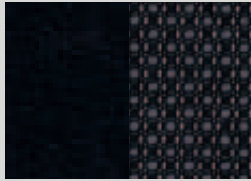

001 black

Leather  
optional extra<sup>1</sup>



201 black



204 cashmere beige



207 sunset red



208 basalt grey

Nappa leather,  
Club design/  
Exclusive nappa  
leather, Club design  
optional extra



861/811 black

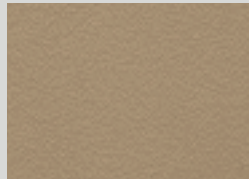

864/814 cashmere beige

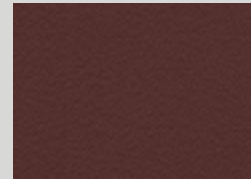

867/817 sunset red

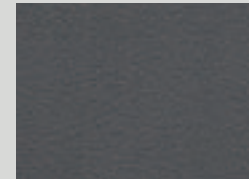

868/818 basalt grey

Nappa leather  
standard in  
CLS 55 AMG/  
Exclusive  
nappa leather  
optional extra  
for CLS 55 AMG



281/581 black

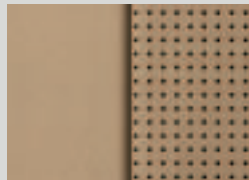

284/584 cashmere beige

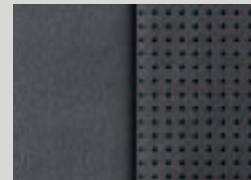

288/588 basalt grey

<sup>1</sup>Standard in the CLS 500

Wood

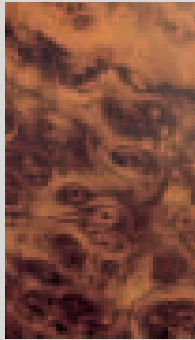

*matt burr walnut*

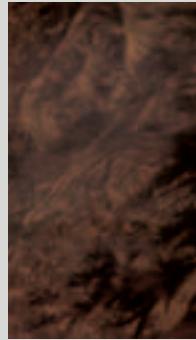

*matt "laurel"<sup>1</sup>*

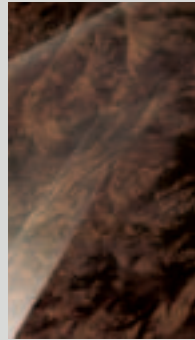

*high-gloss "laurel"<sup>1</sup>*

designo wood<sup>1</sup>

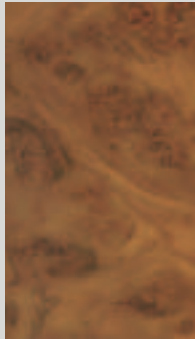

*W21 natural matt  
oak grain*



*W66 designo umber  
maple grain*

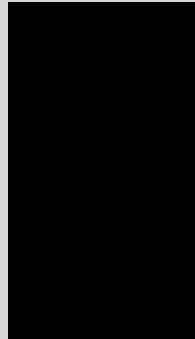

*W69 designo black  
piano lacquer*

<sup>1</sup>Optional extra



designo leather

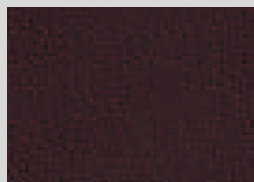

*X06 marron*



*X10 sand*

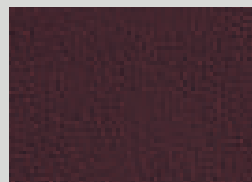

*X13 mystic red*

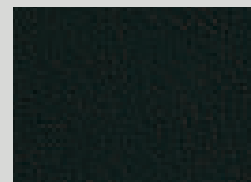

*X14 graphite green*

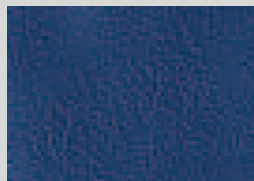

*X16 mauritius blue*



*X17 classic red*

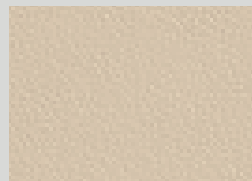

*X27 porcelain*



*X32 chablis*

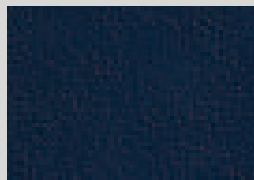

*X40 mystic blue*

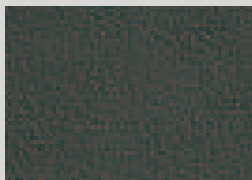

*X49 corteccia*

designo  
Alcantara  
roof liner



*Y83 anthracite*



*Y84 pebble beige*

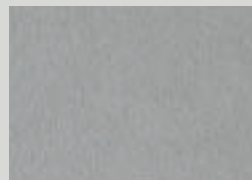

*Y85 alpaca grey*







# Technical data

	<i>CLS 320 CDI</i>	<i>CLS 350</i>	<i>CLS 500</i>	<i>CLS 55 AMG</i>
No. and arrangement of cylinders	6/V	6/V	8/V	8/V
Total displacement (cc)	2987	3498	4966	5439
Rated output (kW at rpm) <sup>1</sup>	165/4000	200/6000	225/5600	350/6100
Rated torque (Nm at rpm) <sup>1</sup>	510/1800 – 2600	350/2400 – 5000	460/2700 – 4250	700/2650 – 4500
Compression ratio	18.0	10.7	10.0	9.0
Acceleration 0 – 100 km/h (s)	7.0	7.0	6.1	4.7
Top speed, approx. (km/h)	246	250 <sup>2</sup>	250 <sup>2</sup>	250 <sup>2</sup>
Tyre size	245/45 R 17	245/45 R 17	245/40 R 18	255/40 R 18 (front) 285/35 R 18 (rear)
Fuel	Diesel	Super unleaded as per DIN EN 228		
Fuel consumption (l/100 km) <sup>3</sup> urban/extra-urban/combined	10.6-11.0/5.9-6.4/7.6-8.1	14.3-15.1/7.8-8.0/10.1-10.6	16.4-17.8/8.3-8.9/11.3-12.1	20.1/9.8/13.6
CO <sub>2</sub> emissions (g/km) <sup>3</sup> combined	202-215	241	268	326
Tank capacity (l), incl. approx. reserve	80/9	80/9	80/9	80/9
Turning circle diameter (m)	11.2	11.2	11.2	11.2
Kerb weight (kg) <sup>4</sup>	1815	1730	1810	1920
Permissible gross vehicle weight (kg)	2280	2195	2275	2385

<sup>1</sup> Figures according to Directive 80/1269/EEC in the currently applicable version <sup>2</sup> Electronically governed <sup>3</sup> The figures shown were obtained in accordance with the prescribed measuring process (Directive 80/1268/EEC in the currently applicable version). The figures are not based on an individual vehicle and do not constitute part of the product offer; they are provided solely for purposes of comparison between different vehicle models. <sup>4</sup> Figures according to Directive 92/21/EC, version 95/48/EC (kerb weight with fuel tank 90 % full, driver, 68 kg, and luggage, 7 kg) for standard-specification vehicles.

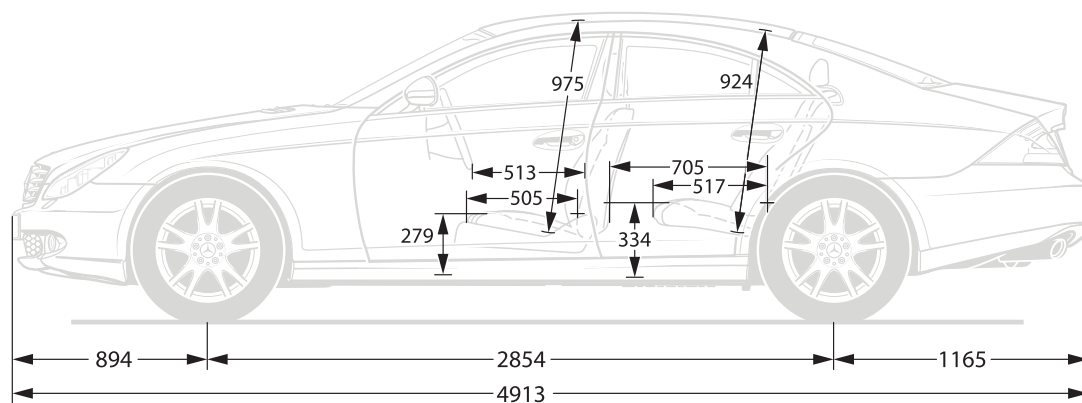
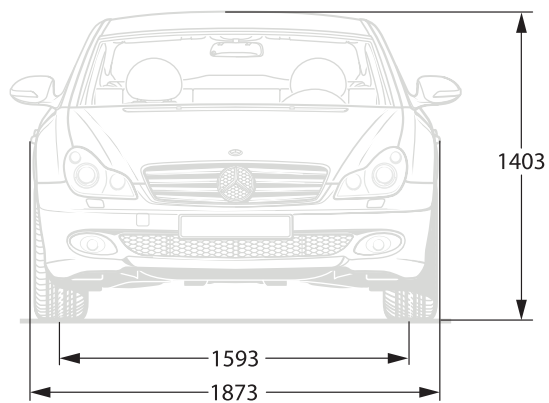

All measurements in millimetres

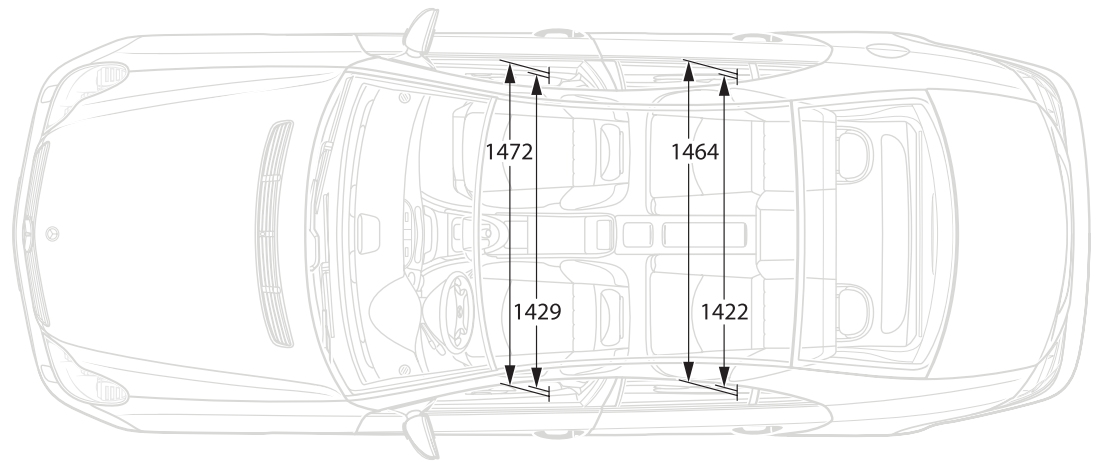
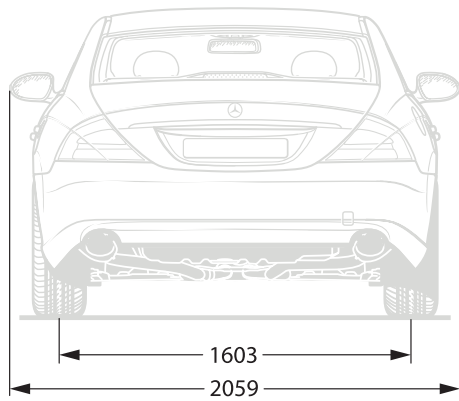









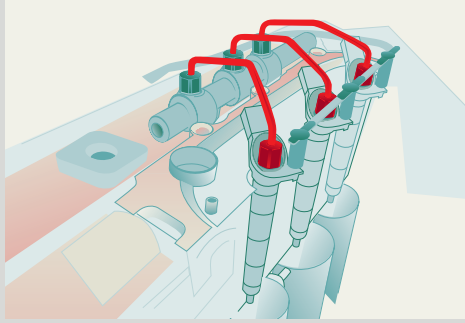

### The common-rail diesel engine

Driving enjoyment, fuel economy, smoothness and low emissions – these are the particular characteristics of the common-rail diesel engine. What makes this all-round talent possible is, among other things, a joint fuel accumulator (common rail) which keeps the fuel at a constant, high pressure of 1600 bar across the whole engine speed range and shoots precisely metered, finely atomised quantities of fuel into the combustion chambers. The result is improved fuel economy and lower pollutant emissions. The common-rail diesel engine meets the strict EU4 limits by a considerable margin. Yet when it comes to tractive power, this V6 diesel

engine is anything but modest: numerous new features such as piezo injectors and a higher ignition pressure ensure effortless progress from A to B. As well as a clean environment: the standard-fitted diesel particulate filter eliminates over 95 % of the soot particles from the exhaust gas. At the same time a constantly active regeneration process prevents the filter from clogging up at an early stage.

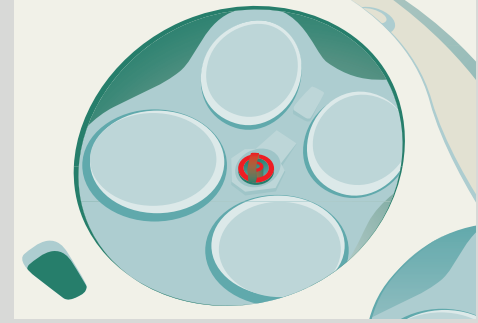

### Petrol engines with four valves per cylinder

The use of four valves per cylinder in combination with adjustable intake and exhaust camshafts improves the rated output and torque across a wide engine-speed range. The optimised combustion chamber results in lower fuel consumption and pollutant emissions while a balancer shaft makes for smoother running and reduces vibration.





### 7G-TRONIC

7G-TRONIC is a 7-speed automatic transmission. Seven gear ratios provide a larger ratio spread and can react on the basis of smaller differences in engine speed. This produces faster, smoother shift operations which, in turn, make for smoother running and improved ride comfort. 7G-TRONIC employs the multiple downshift principle. This means that a number of gears can be skipped when shifting down. 7G-TRONIC helps to reduce fuel consumption and emission levels.

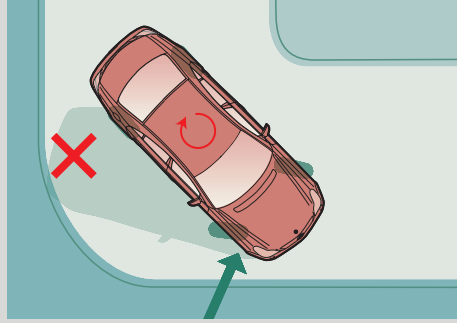

### ESP® with tyre pressure loss warning system

If your car is in danger of skidding, the Electronic Stability Program ESP® is instantly activated. Its sensors recognise certain critical handling situations at an early stage (e.g. the fact that a wheel is spinning or is losing contact with the road). ESP® throttles back the engine torque and applies a precisely metered brake force to one or more wheels in order to stabilise the vehicle. The integrated tyre pressure loss warning

system also increases driving safety. It is able to recognise a significant pressure loss in a tyre and displays a warning in the instrument cluster. This allows the driver to respond to a critical situation at an early stage by using the spare wheel or the TIREFIT repair kit. However, the tyre pressure loss warning system is not a substitute for regular checking of the pressure and condition of the tyres.

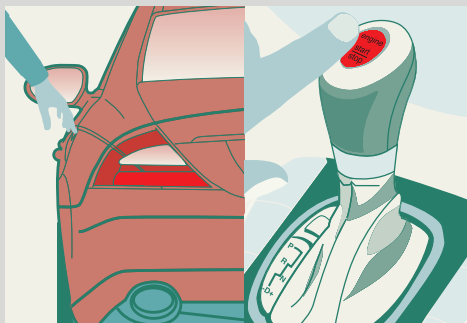

### KEYLESS-GO

If you are carrying KEYLESS-GO, the electronic key, with you, all you need to do is take hold of the door handle to unlock the door. It's not magic – it's all down to radio frequency communication between the KEYLESS-GO key and the vehicle electronics. You don't even need to put the key in the ignition either: the engine can be turned on and off using a button on the selector lever in the centre console.

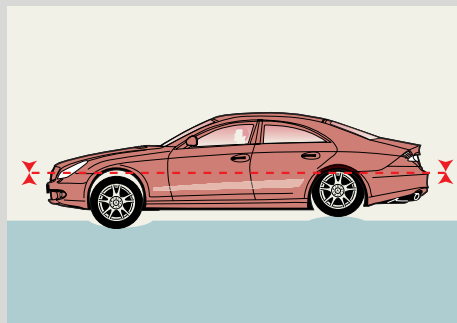

### AIRMATIC Dual Control

What kind of ride would you like your CLS to have – one that maximises its sporty handling potential or one which puts the emphasis on comfort? With the AIRMATIC DC (AIRMATIC Dual Control) semi-active air suspension system, you can make your choice at the touch of a button. Instead of conventional coil springs, an electronic system adjusts the setting of the air springs by using compressed air to create a harder or softer set-up to suit the given situation. Each spring strut has an additional volume of air which can be partially deactivated according to requirements. If the sensors register a sporty driving style, for instance, the comfortable basic

suspension automatically becomes firmer. Springing and damping can also be adjusted manually: with the aid of a switch, you can choose between comfort, sports/comfort and sports. The semi-active air suspension system also includes an Adaptive Damping System. The fully automatic electronics operate with four different damping stages which adjust the damping force at each wheel as required at any given moment. The result: the ride is beautifully smooth and directional stability is not impaired by poor road surfaces. To ensure that the level of the vehicle remains constant, the system is also fitted with all-round self-levelling suspension. When driving fast, the body is automatically lowered, thus reducing pitch and roll angles. If necessary, you can raise the level of the vehicle manually by up to 25 mm, e.g. where the quality of the road is poor.

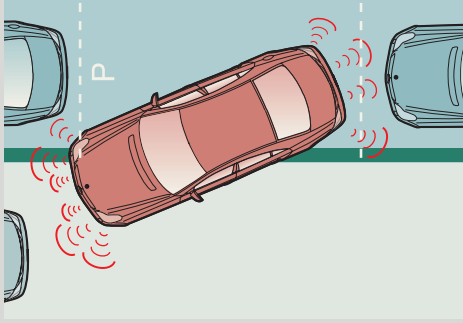

#### **PARKTRONIC**

This electronic system helps you to park and to manoeuvre your way out of a tight parking spot. Like an echo sounder, it sends out ultrasonic signals which are bounced back off obstacles in your vehicle's path. Displays in the interior show how close the vehicle is to a detected obstacle. Depending on the distance, yellow or red signals provide warnings. If the gap falls below a certain limit, PARKTRONIC also emits a continuous warning tone.



#### **LINGUATRONIC**

To control the audio, communication and navigation systems, all you need is your voice and LINGUATRONIC. The system helps enhance safety since it allows you to keep both hands on the steering wheel. If LINGUATRONIC is activated, your voice is all it takes to dial a telephone number or enter the destination in the navigation system. Only a few words are required in order to operate the telephone. A selection of easy-to-remember commands allows you to dial, store numbers, make a telephone call or control the navigation system.

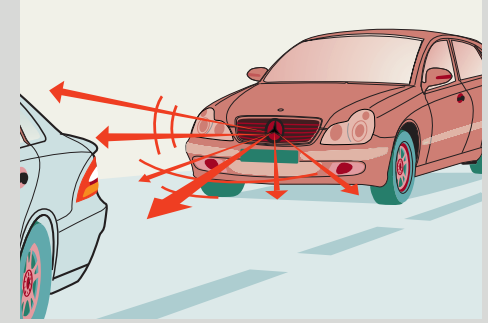

#### **DISTRONIC**

The DISTRONIC proximity control system helps you to keep a set distance from the vehicle in front in specific traffic situations (in the speed range from around 30 km/h to 180 km/h). A radar sensor registers your distance and speed relative to the vehicle ahead. If the distance falls below the set limit, the brakes will be activated if necessary. Once the distance increases again, the vehicle accelerates to the preset speed. Both vehicles and the distance between them are shown in the instrument cluster display. If the driver is required to brake heavily, an audible warning is also sounded.



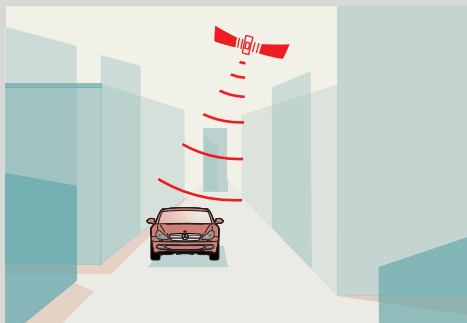

#### COMAND APS

The COMAND APS system works with the Global Positioning System, GPS. Enter your destination into the system, and COMAND APS works out the route. A voice or direction arrows in the display tell you which way to go. Dynamic route guidance is an additional service (available in Germany and some other European countries) which uses traffic information broadcast by radio stations to guide you around tailbacks where there is an alternative route.

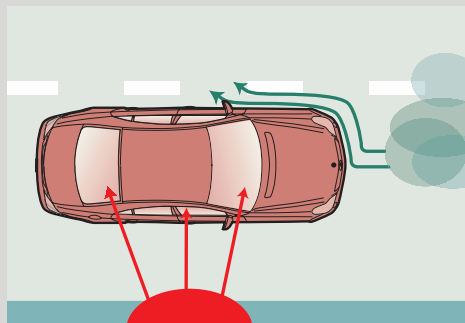

#### THERMOTRONIC 4-zone automatic climate control

THERMOTRONIC allows each occupant to choose his or her own preferred temperature and airflow settings. Sensors monitor the intensity of the sunlight and automatically adjust the interior temperature and blower settings for a pleasant atmosphere. The intake-air quality is improved by a combined dust and activated charcoal filter while a dew-point sensor monitors air humidity and helps to prevent the windows from misting up. The nine-speed blower with its control unit behind the armrest optimises the heating or cooling effect for the rear-seat passengers.

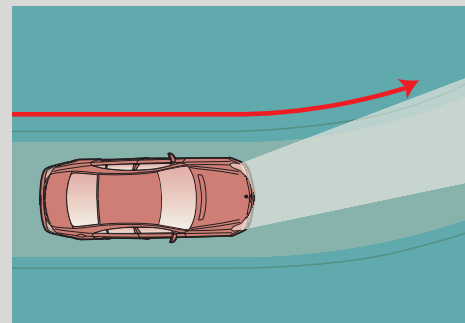

#### Active Light System

When you drive around a bend with the headlamps switched on, the low-beam light from them is usually directed straight ahead. The bi-xenon headlamps with the Active Light System improve illumination of bends by up to 90% by following the driver's steering movements. For example, when entering a bend with a radius of 190 metres (in relation to the centre line of the road), the illuminated area measures about 30 metres. The Active Light System extends this by 25 metres, helping you to detect any obstacles earlier.

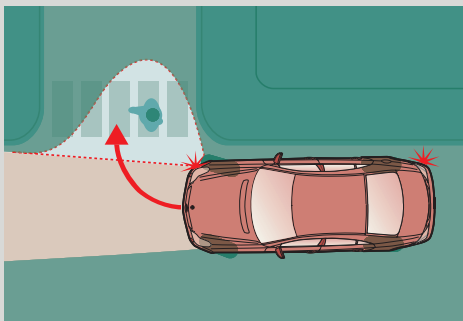

### Cornering light

The cornering light function extends the scope of the optional bi-xenon headlamps. By using the wider light beam from the front fog lamp, the cornering light function provides significantly improved illumination of the road or entrance into which the vehicle is turning. The left or right front fog lamp is switched on when the headlamps are on, the vehicle speed is less than 40 km/h and the indicators are operated or a given steering angle is applied. As a result, pedestrians and potential obstacles can be identified at an early stage and accidents avoided.

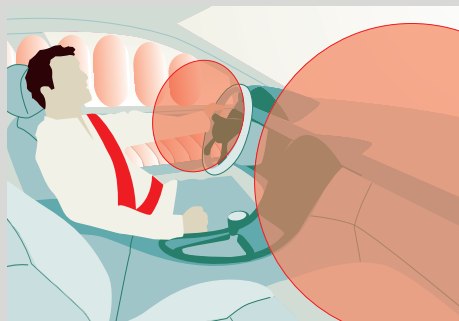

### Belt systems and airbags

In the event of a front-end or rear-end collision of a specific severity, the seat belts are pulled taut against the body by the belt tensioners almost instantaneously. The CLS is equipped as standard with driver and front-passenger airbags as well as side airbags in the front and windowbags. The severity of a front-end collision is taken into account in fractions of a second in order to determine whether one or both stages of the front airbags should be triggered. Deployed in a side impact, sidebags and windowbags offer additional protection by reducing the risk of chest and head injuries. An additional roll-over sensor triggers all the belt tensioners

and both windowbags in certain roll-over situations. In a rear-end collision the crash-responsive NECK-PRO head restraints protect the occupants' neck vertebrae by moving upwards and forwards, reducing the distance between head and head restraint and thereby lessening the amount of sudden rearward movement by the head.

The most important restraint system is the 3-point seat belt. Airbags can provide additional protection, but are subject to complex activation criteria which mean that they are not triggered in every accident. Details can be found in the Owner's Manual or in the "Seat belts and airbags" brochure which can be downloaded as a PDF file from [www.mercedes-benz.com/airbag-brochure](http://www.mercedes-benz.com/airbag-brochure). The brochure can also be ordered from the following address: Mercedes-Benz Customer Assistance Center, "Airbag brochure", PO-box 14 56, 6201 BL Maastricht, Netherlands.







## Enjoy a sense of security wherever you are

Life has a habit of springing surprises on us. So it's reassuring to know that you're in good hands if something should go wrong. With MobiloLife, our mobility and warranty package, you can expect up to 30 years of carefree driving (if you observe our conditions), 24 hours a day, in almost every country in Europe. One call is all it takes, and we will immediately arrange for assistance to be provided. You can contact us on 00800 1777 7777. Your Mercedes-Benz dealer will be pleased to tell you about the terms and conditions.

The MercedesCard is your ticket to the world of Mercedes-Benz and is a practical credit card at the same time. Information about the MercedesCard and the exclusive offers associated with it is available on 00800 62 00 31 90 in Germany, 0800 55 79 84 in Switzerland and 0800 20 65 65 in Austria.







**Take-back of end-of-life vehicles. Coming full circle**

At the end of its long life, you can return your CLS-Class to us for environment-friendly disposal in accordance with the EC End-Of-Life Vehicle Law<sup>1</sup>.  
But that day lies a long way off.

<sup>1</sup>Applies in accordance with national regulations to vehicles up to 3.5 tonnes gross weight.

Mercedes-Benz passenger cars have met the statutory regulations governing the suitability of their design for reuse and recycling for a number of years now.

A network of vehicle take-back depots and dismantlers has been established which will process your vehicle in an environment-friendly manner.

The ways in which both vehicles and parts can be recovered are subject to ongoing development and improvement. Consequently, the CLS-Class will be able to comply with any future increases in the recycling quota within the stipulated time limits. For further information, please call 00800 1777 7777.

Please note: changes may have been made to the product since this brochure went to press (30.09.2005).

The manufacturer reserves the right to make changes to the design, form, colour and specification during the delivery period, provided these changes, while taking into account the interests of the vendor, can be deemed reasonable with respect to the purchaser. Where the vendor or the manufacturer uses symbols or numbers to describe an order or the subject of an order, no rights may be derived solely from these. The illustrations may show accessories and items of optional equipment which are not part of standard specification. Colours may differ slightly from those shown in the brochure, owing to the limitations of the printing process. This brochure has been compiled by DaimlerChrysler AG of Germany and is distributed internationally. It provides a general indication of the range of models, features, optional extras and/or colours available in various countries. Some of the models, features, optional extras and/or colours shown may not be available in your country or may only be available in a different specification. Additionally some models, features, optional extras and/or colours may only be available in combination with others. For current and more specific information in relation to the range of models, features, optional extras and/or colours available in your country, and their pricing, you should contact your nearest authorised Mercedes-Benz Passenger Car Dealer.

DaimlerChrysler AG, StuttgartMKP/K 6701 · 0703 · 02-02/1105 Printed in Germany

[www.mercedes-benz.com](http://www.mercedes-benz.com)