

This brochure has been compiled by DaimlerChrysler AG of Germany and is distributed internationally. It provides a general indication of the range of models, features, optional extras and/or colours available in various countries. Some of the models, features, optional extras and/or colours shown may not be available in your country or may only be available in a different specification. Additionally some models, features, optional extras and/or colours may only be available in combination with others. For current and more specific information in relation to the range of models, features, optional extras and/or colours available in your country, and their pricing, you should contact your nearest authorised Mercedes-Benz Passenger Car Dealer.





THE C-CLASS SPORTS COUPÉS



Mercedes-Benz

Paper cannot wrap up a fire (Chinese proverb)



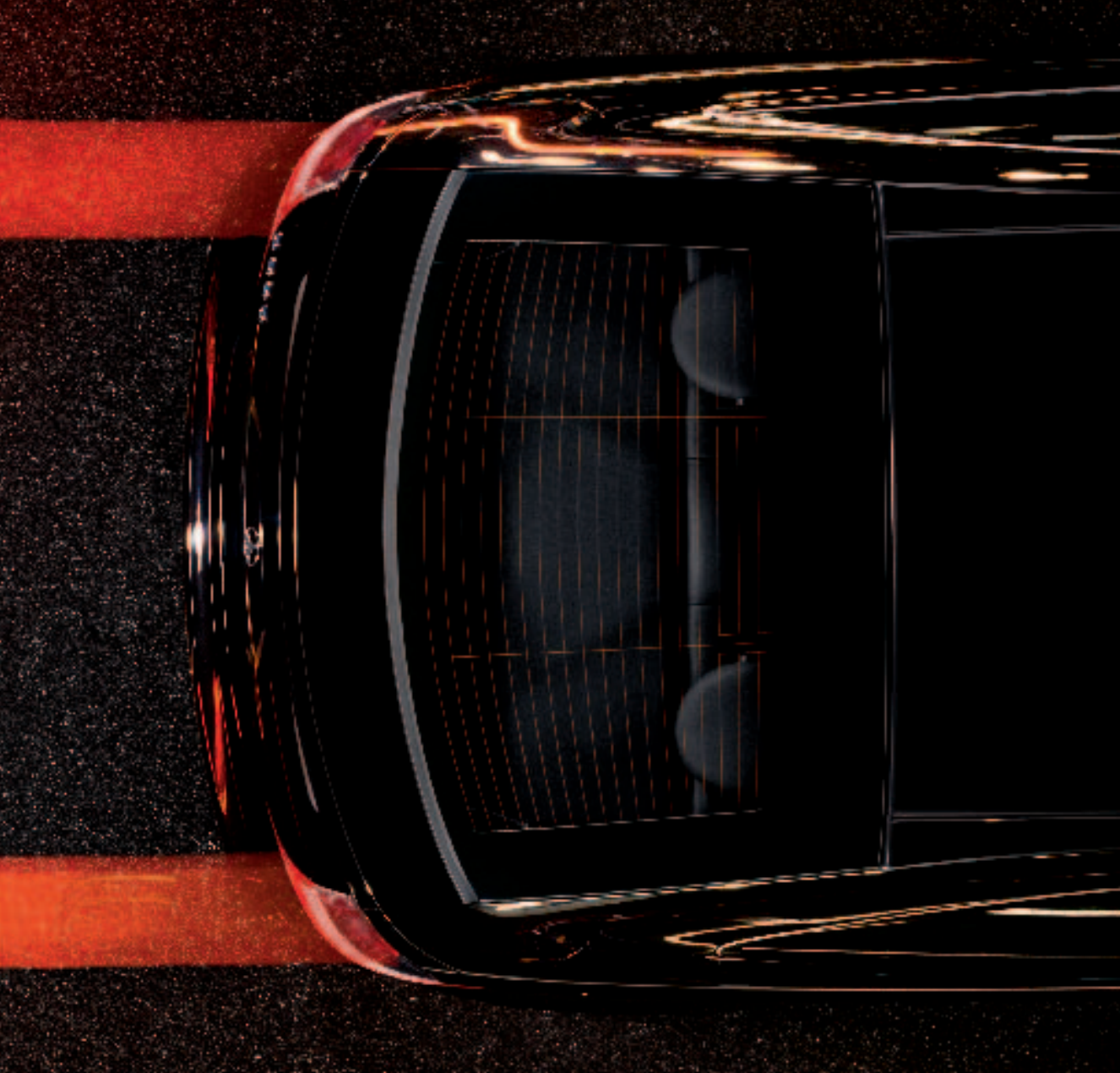

Contents

04	Fire
10	Dynamic handling
12	Drive system
16	Design
22	Comfort
26	Safety
28	EVOLUTION sports package
34	EVOLUTION AMG sports package
38	designo
40	Equipment
46	Accessories
48	Technical data
50	Dimensions
52	Paintwork and upholstery
56	Glossary





The story of fire.

Introducing the latest chapter

Fire – it has cast its spell over mankind for over 500,000 years now, losing nothing of its fascination with the passing of time. In fact we're pleased to announce that the heat has been turned up a notch – in the C-Class Sports Coupés, with new-generation 6-cylinder engines in the C 230 and C 350. The flames are fanned by two 4-cylinder petrol engines or by one of the two efficient, high-torque common-rail diesel engines.

Whichever you opt for, you'll be reassured to know that, thanks to the DIRECT CONTROL dynamic handling package, you're well and truly in the driving seat. The sporty suspension tuning and the direct steering produce significantly enhanced agility. And the DIRECT CONTROL gearshift, with its shorter shift travel, ensure a sporty driving sensation – without any compromises in terms of comfort.













The art of taming the flames

The C-Class Sports Coupé is a car that turns pure energy into pure driving enjoyment, its ingenious suspension technology and wider track ensuring enhanced road-holding. The Electronic Stability Program (ESP[®]), Brake Assist (BAS) and the anti-lock braking system (ABS) are there to help in critical handling situations. And the DIRECT CONTROL 6-speed manual transmission makes for fast, precise gearshifts.

A pyrotechnic display of intelligent technology

The new-generation 6-cylinder engines in the C-Class Sports Coupé are designed to deliver even more driving pleasure. The C 230 has an output of 150 kW/204 hp, while the new C 350 delivers an impressive 200 kW/272 hp. The 350-Nm torque gives it a leading edge in its class. Thanks to the optimised fuel combustion, consumption has been reduced by up to 10 %. With their TWINPULSE system, the KOMPRESSOR engines also demonstrate enhanced dynamism and low consumption.

The C 200 CDI and the C 220 CDI feature cutting-edge common-rail diesel technology, delivering impressive power and gratifying smoothness. Thanks to the particulate filter, which is fitted as standard, they are also kind to the environment. Whichever version you opt for, you will be getting a true powerhouse, packed with flashes of inspiration.









Smouldering good looks

The C-Class Sports Coupé: a face this brimming with energy leaves a lasting impression. Its fiery eyes have been refined with clear-lens headlamps, while the larger air intakes in the front bumper and the perforated radiator grille – part of the EVOLUTION sports package – help it to keep its cool. At the same time, the refined suspension tuning and wider track give the impression that the Sports Coupé is a car that's so hot it's positively fused with the road.

The tougher clearcoat is significantly more scratch-resistant than conventional paint and is characterised by a more durable sheen which is noticeably more intense. The secret behind this protective layer lies in the countless ceramic particles – each less than a millionth of a millimetre in size – that have been integrated into the molecular structure of the paint binding agent.









The sportily wide rear and, in particular, the high-gloss tail lights have found many ardent admirers.

A chrome package comprising chrome highlights on the bumpers, rub strips and door handles is available as an option. The exterior mirrors are fitted with integral indicators





Enjoy sunny prospects. Wherever you are

Take a seat in your C-Class Sports Coupé and feel the stress just melt away. You could almost be on holiday. The sports seats have reinforced upholstered sections on the left and right of the backrests, providing firm support, even on tight bends. The multi-function steering wheel also helps enhance safety by allowing you to keep your hands on the wheel while you answer the phone, for example. From the telephone and the CD player (now MP3-compatible) to the navigation system, all functions can be controlled using the optional COMAND APS control and display system with its easily comprehensible layout. The optional harman/kardon LOGIC 7® surround sound system ensures a very special acoustic experience. And the standard EASY-ENTRY function makes it easier for the rear passengers to get in and out – just fold the front backrests forward. All that remains for you to do is enjoy the drive.









When it's hot outside, a light breeze can be very refreshing. Get that cabriolet feeling in your Sports Coupé with the electrically operated glass panoramic sliding sunroof, available as an optional extra. The central panel slides over the rear one, creating a larger opening than would be produced by a conventional sliding sunroof, and the front section stands up and acts as a wind-deflector. To provide protection from the sun, there are electric blinds which can be moved forwards and back. You can also keep the interior cool using the standard THERMATIC automatic climate control system. This ensures that the selected interior temperature remains constant, even when outside temperatures soar. The optional THERMOTRONIC luxury automatic climate control system allows you to adjust the temperature individually for all four occupants

When it comes to your safety, the C-Class Sports Coupé certainly shows the way. The light from the bi-xenon headlamps is brighter and extends further than that of conventional headlamps. If you choose this optional extra, you will also enjoy another safety benefit: when cornering, one of the fog lamps is automatically activated, providing better illumination of the road. And if you activate Headlamp Assist, the standard-fitted light sensor, it automatically switches the headlamps on for you as soon as it starts to get dark. The C-Class Sports Coupé's comprehensive safety package is rounded off by the seat belt and airbag systems.





Boundless energy

That's the look created when the C-Class Sports Coupé is equipped with the EVOLUTION sports package. This model includes sports suspension – the body being lowered by 15 mm at the front axle and 5 mm at the rear - for even more direct and agile handling.

With 17-inch light-alloy wheels, door handles in vehicle colour and an enlarged stainless steel exhaust tailpipe, the EVOLUTION sports package is sure to turn heads.









The EVOLUTION sports package – designed to bring a sparkle to your eyes. The studded pedals in brushed stainless steel are just the beginning. On the outside there's a powerful-looking radiator grille with a perforated design and less steeply raked slats. Back in the interior there's a leather steering wheel with thumb-rests plus floor mats with "EVOLUTION" lettering. Sports seats in ARTICO Leather, an elegant man-made leather, are available as an option. And the Alu-tecra aluminium trim also makes a gleaming impression

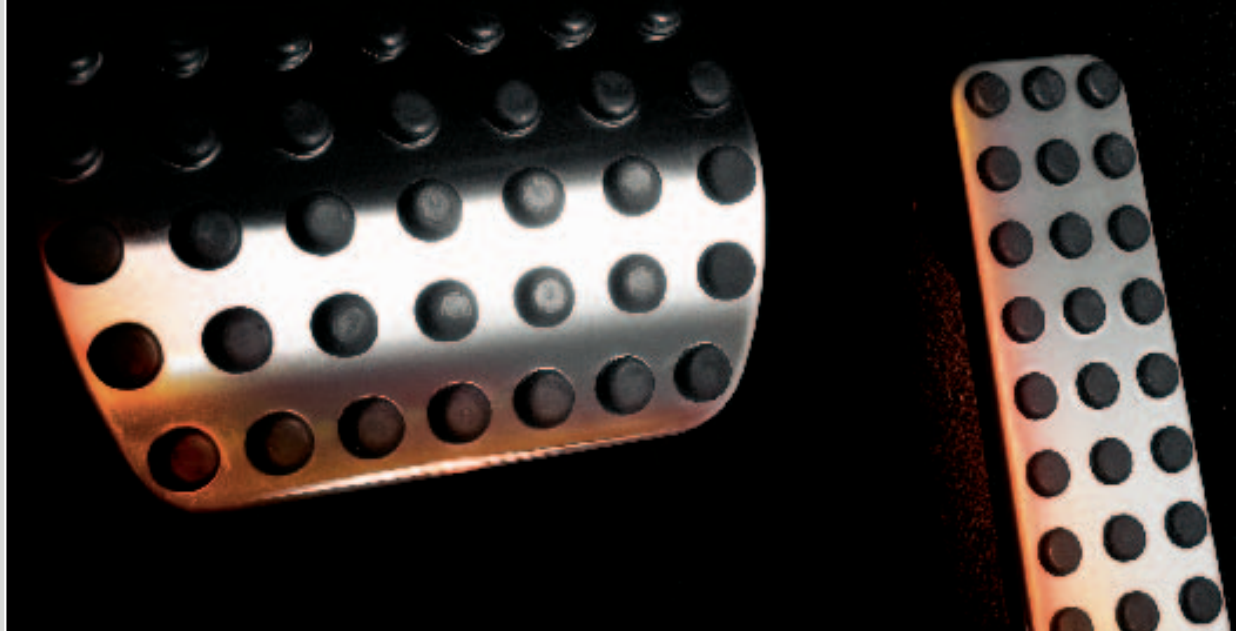



For the true sports fan

The EVOLUTION AMG sports package includes all the equipment features of the EVOLUTION sports package plus AMG bodystyling, giving the C-Class Sports Coupé an even more dynamic look – almost like a racing car. It features a front apron with integral fog lamps, a dynamic rear apron and the AMG spoiler lip, plus matching 17-inch AMG light-alloy wheels. To find out what else the motor racing specialists at AMG have developed for you, take a look at our AMG “Optional extras and accessories” brochure.







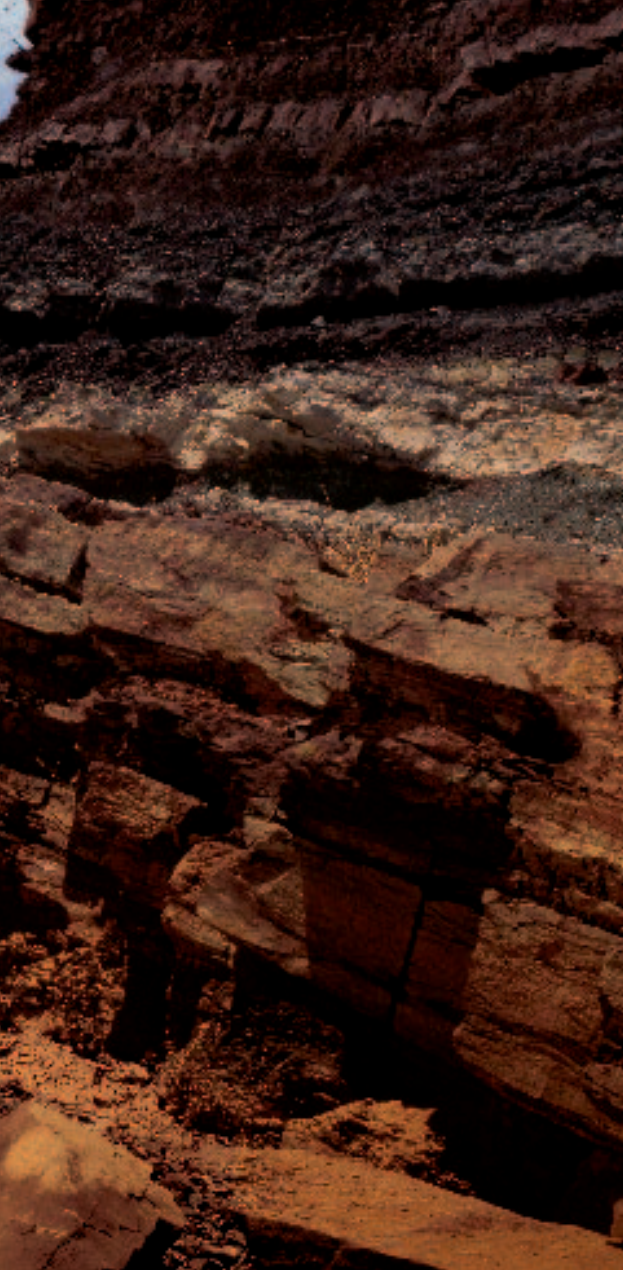



designo

It's an explosive blend, the combination of lava red and black for the optional designo seat leather. designo trim in anthracite cinnamora provides an elegant contrast. Further suggestions for the interior of your C-Class Sports Coupé can be found in our designo brochure



Equipment for the C-Class Sports Coupés

Standard equipment (selection)

3-point seat belts and head restraints for all seats
16-inch steel wheels with wide-base tyres ¹
Airbags (two-stage) for driver and front passenger
ASSYST service interval indicator
Belt tensioners with belt force limiters, front and rear
Brake Assist (BAS)
Brake pad wear indicator
Central locking (remote control with selective and global opening)
Clear-lens fog lamps
Clear-lens headlamps, indicators, tail lights and brake lights with high-gloss effect
Cruise control with SPEEDTRONIC variable speed limiter
DIRECT CONTROL 6-speed manual transmission
DIRECT CONTROL power steering with safety steering column
DIRECT CONTROL suspension
EASY-ENTRY SYSTEM for rear-seat passengers
Electronic Stability Program (ESP®)
Front armrest, height-adjustable, with stowage compartment and cup holder

Headlamp Assist
Heated exterior mirrors, electrically adjustable, aspherical, with clear-lens indicators
Heated rear window with time relay
Immobiliser with ELCODE locking system and infrared remote control
Multifunction steering wheel, 3-spoke design, with control buttons
Outside temperature display
Power windows, 2, with one-touch control
Seat occupancy sensor for front passenger seat
Sidebags for driver and front passenger
Sports seats
Steering column manually adjustable for height and reach
THERMATIC automatic climate control
Through-loading facility, rear bench seat folds fully or with 1/3 : 2/3 split
Tinted glass
Windowbags

¹ 5-spoke, 16-inch light-alloy wheels with wide-base tyres standard on C 230; 5-spoke, 17-inch light-alloy wheels with wide-base tyres standard on C 350

Optional extras (selection)

5-speed automatic transmission¹

7G-TRONIC 7-speed automatic transmission²

Anti-theft alarm system (ATA) with tow-away protection

Audio 20 CD radio

Audio 50 APS radio with CD navigation system

Auxiliary heater with remote control

Bi-xenon headlamps with cornering light function³

CD changer in glove compartment (for 6 CDs), MP3-compatible

Chrome package: chrome highlights for bumpers, rub strips and door handles

COMAND APS control and display system with DVD navigation system

EVOLUTION sports package

EVOLUTION AMG sports package

Exterior mirrors, left and right, folding and automatically dimming

harman/kardon LOGIC 7[®] surround sound system

Headlamp cleaning system

Heated front seats

Leather steering wheel and shift/selector lever

¹ Available for C 200 CDI, C 220 CDI, C 180 KOMPRESSOR and C 200 KOMPRESSOR

² Available for C 230 and C 350

³ Cornering light function not available in conjunction with EVOLUTION AMG sports package

⁴ Only in conjunction with memory package





One glance is enough to kindle the emotions:

1. The EVOLUTION sports package with 7-spoke, 17-inch light-alloy wheels and mixed-size tyres (225/45 front, 245/40 rear)

2. The 7-spoke design shown in the small picture belongs to the 16-inch steel wheel with wheel trim (205/55 front and rear), standard on all models. The C 230 features 16-inch and the C 350

17-inch light-alloy wheels as standard

3. 5-spoke, 17-inch light-alloy wheels (225/45 front and rear): an optional extra available for all Sports Coupé models – except those fitted with the EVOLUTION and EVOLUTION AMG sports packages

4. The 5-spoke, 18-inch AMG light-alloy wheels (225/40 front, 245/35 rear) have a refined sterling silver paint finish

Keep up-to-the-minute in the C-Class Sports Coupé with your very own communications centre: the optional COMAND APS control and display system. Its DVD navigation system guides you quickly and safely to your destination. There is also a radio with CD player and a clear LCD display. Compatible extension modules for COMAND APS include the LINGUATRONIC voice control system, the MP3-compatible CD changer, the premium harman/kardon LOGIC 7® surround sound system (12 loudspeakers, 320 Watts) and the telephone. Below the LCD display you can see the temperature display for the optional THERMOTRONIC luxury automatic climate control system. The system is able to adjust the interior temperature automatically if, for example, the sun becomes brighter or disappears behind clouds.





The gas-discharge bi-xenon headlamps shine brighter and have a longer range than conventional headlamps. The low-beam setting provides sharper and wider illumination of the edges of the road, and the main-beam setting has a significantly greater range. On the right you can see the switches for the light sensor, which automatically activates the headlamps when it gets dark outside. The picture on the lower left shows the automatic transmission's aluminium-trimmed selector lever. Next to it, the optional, electrically folding exterior mirrors, which are also automatically dimming, ensuring that you are not dazzled by the headlamps of the car behind



Here are a few more of the highlights to be found in the range of genuine Mercedes-Benz accessories. Some extras were specifically developed for the Sports Coupé: from the child seat and the coolbox to the illuminated door sill panels. Winter sports fans can transport their skis in the specially-designed roof box. The complete range can be found in our “Accessories for the C-Class Sports Coupé” brochure.





Technical data

	<i>C 200 CDI</i>	<i>C 220 CDI</i>	<i>C 180 KOMPRESSOR</i>	<i>C 200 KOMPRESSOR</i>
No. of cylinders/arrangement	4/in-line	4/in-line	4/in-line	4/in-line
Bore/stroke (mm)	88.0/88.3	88.0/88.3	82.0/85.0	82.0/85.0
Total displacement (cc)	2148	2148	1796	1796
Rated output (kW at rpm) ¹	90/4200	110/4200	105/5200	120/5500
Rated torque (Nm at rpm) ¹	270/1600–2800	340/2000	220/2500–4200	240/3000–4000
Compression ratio	18.0	18.0	10.0	9.3
Acceleration 0–100 km/h (s) (automatic transmission)	11.7 (11.9)	10.3 (10.5)	9.7 (9.9)	9.1 (9.4)
Top speed, approx. (km/h) (automatic transmission)	208 (203)	224 (218)	223 (220)	234 (231)
Tyre size	front rear	205/55 R 16 205/55 R 16	205/55 R 16 205/55 R 16	205/55 R 16 205/55 R 16
Fuel	Diesel	Diesel	Premium	Premium
Fuel consumption (l/100 km) ³				
urban (automatic transmission)	8.6–8.8 (9.3–9.4)	8.9–9.0 (9.1–9.2)	11.4–11.6 (11.7–12.0)	11.9–12.4 (12.1–12.7)
extra-urban (automatic transmission)	5.3–5.5 (5.6–5.7)	5.3–5.4 (5.7–5.8)	6.1–6.4 (6.1–6.6)	6.4–6.9 (6.5–6.7)
combined (automatic transmission)	6.5–6.7 (6.9–7.0)	6.6–6.7 (6.9–7.0)	8.0–8.3 (8.2–8.5)	8.4–8.9 (8.5–8.9)
CO ₂ emissions (g/km) ³ (automatic transmission)	172–177 (183–185)	174–176 (183–185)	191–198 (193–203)	200–212 (202–212)
Tank capacity (l), incl. reserve, approx.	62/8	62/8	62/8	62/8
Turning circle diameter (m)	10.76	10.76	10.76	10.76
Kerb weight ⁴ /perm. gross vehicle weight (kg)	1490/1945	1515/1970	1465/1935	1465/1935

	<i>C 230</i>	<i>C 350</i>
No. of cylinders/arrangement	6/V	6/V
Bore/stroke (mm)	88.0/68.4	92.9/86.0
Total displacement (cc)	2496	3498
Rated output (kW at rpm) ¹	150/6010	200/6000
Rated torque (Nm at rpm) ¹	245/2900–5500	350/2400–5000
Compression ratio	11.2	10.5
Acceleration 0–100 km/h (s)	8.4	6.4
Top speed, approx. (km/h)	241 (234)	250 ²
Tyre size	front rear	225/45 R 17 225/45 R 17
Fuel	Premium	Premium
Fuel consumption (l/100 km) ³		
urban (automatic transmission)	13.5–13.8 (13.2–13.5)	13.7–14.0 (13.9–14.2)
extra-urban (automatic transmission)	6.8–7.1 (7.1–7.4)	7.0–7.3 (7.3–7.6)
combined (automatic transmission)	9.3–9.6 (9.3–9.6)	9.5–9.8 (9.7–10.0)
CO ₂ emissions (g/km) ³ (automatic transmission)	222–229 (222–229)	227–234 (232–239)
Tank capacity (l), incl. reserve, approx.	62/8	62/8
Turning circle diameter (m)	10.76	10.76
Kerb weight ⁴ /perm. gross vehicle weight (kg)	1515/1985	1540/2010

¹ Figures according to Directive 80/1269/EEC in the currently applicable version.

² Electronically governed

³ The figures shown were obtained in accordance with the prescribed measuring process (Directive 80/1268/EEC in the currently applicable version).

The figures are not based on an individual vehicle and do not constitute part of the product offer; they are provided solely for purposes of comparison between different vehicle models

⁴ Figures according to Directive 92/21/EC, version 95/48/EC (kerb weight with fuel tank 90% full, driver, 68 kg, and luggage, 7 kg) for standard-specification vehicles.

Optional extras and accessories will generally increase this figure and reduce the payload capacity accordingly

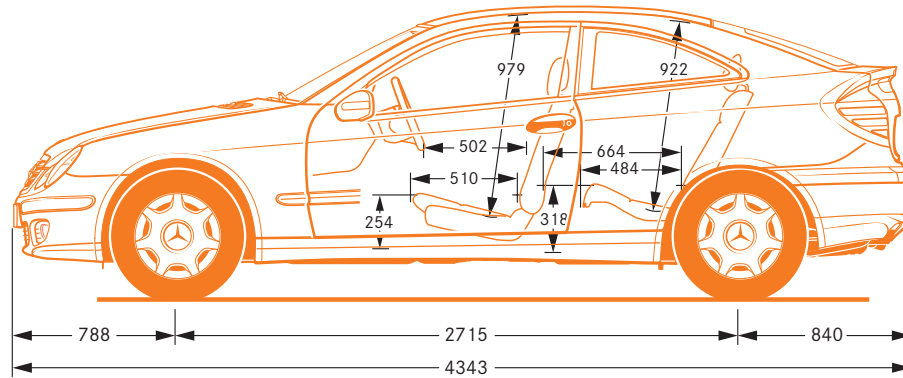
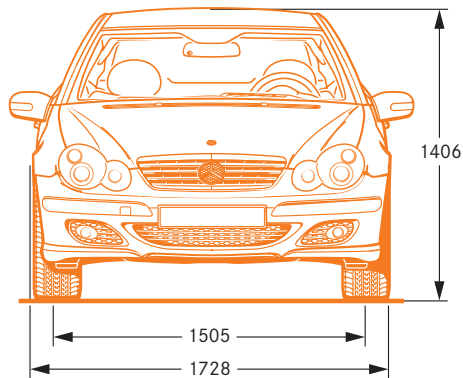

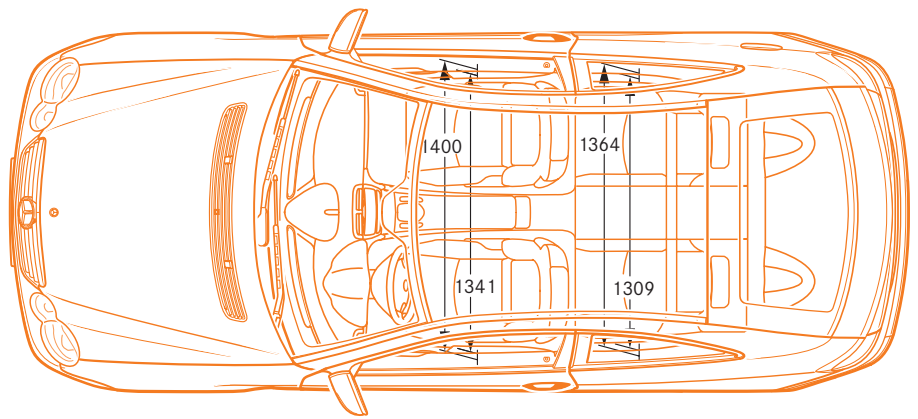
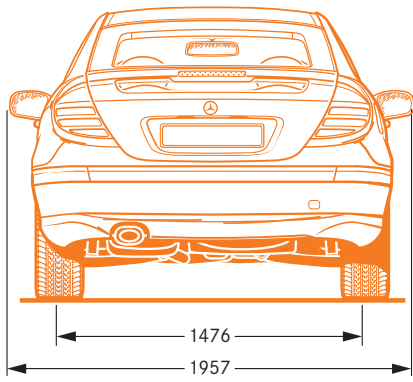

The dimensions, shown in mm, are average values for the unladen, standard-specification vehicle

**Non-metallic
paints**

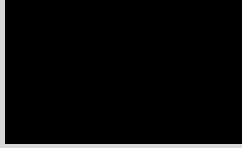

040 black



590 fire opal

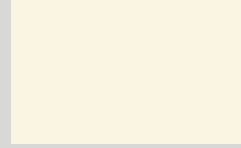

960 alabaster white

**Metallic paints
optional extra**



189 green black



197 obsidian black



345 jasper blue



359 tanzanite blue



487 aventurine orange



544 carneol red



723 cubanite silver

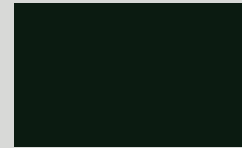

755 tenorite grey

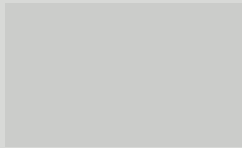

775 iridium silver

Tougher clearcoat

The clearcoat used on the C-Class is significantly more scratch-resistant than conventional paint and is characterised by a more durable sheen which is noticeably more intense. The secret of this protective coat is to be found in the countless tiny ceramic particles (each less than one millionth of a millimetre in size) which are integrated in the paint binding agent. Both non-metallic and metallic paint finishes benefit from the more scratch-resistant clearcoat which makes them less susceptible to the effects of the weather and environmental conditions such as precipitation, sunlight, temperature variations, dust and soot.

“Leeds” fabric



041 black

048 alpaca grey

Aluminium

Alu-linea
standard

*(except in conjunction with
EVOLUTION/EVOLUTION AMG
sports package)*

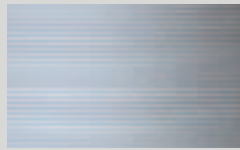

Aluminium

Alu-tecra
standard

*in conjunction with
EVOLUTION/EVOLUTION AMG
sports package*

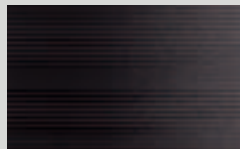

Leather
optional extra

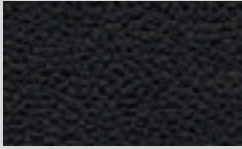

231 black



238 alpaca grey

designo trim
optional extra

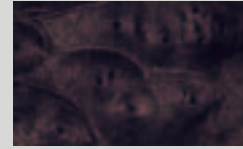

W52 anthracite cinnamora



W68 brown poplar

ARTICO Leather¹
optional extra
in conjunction with
EVOLUTION/
EVOLUTION AMG
sports package only



128 alpaca grey²

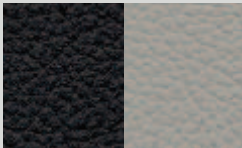

168 black³

¹Man-made leather

²Centre console, door panels, rear side panels and carpets in alpaca grey, seats in black/alpaca grey

³Centre console, door panels, rear side panels and carpets in black, seats in black/alpaca grey

Paintwork and upholstery – the combination options

	<i>“Leeds” fabric</i>		<i>ARTICO Leather¹</i>		<i>Leather</i>	
	black	alpaca grey	black	alpaca grey	black	alpaca grey
<i>Non-metallic paints</i>						
black	●	●	●	●	●	●
fire opal	●	●	●	●	●	●
alabaster white	●	●	●	●	●	●
<i>Metallic paints</i>						
green black	●	●	●	●	●	●
obsidian black	●	●	●	●	●	●
jasper blue	●	○	●	○	●	○
tanzanite blue	●	●	●	●	●	●
aventurine orange	●	●	●	●	●	●
carneol red	●	●	●	●	●	●
cubanite silver	●	●	●	●	●	●
tenorite grey	●	●	●	●	●	●
iridium silver	●	●	●	●	●	●

● Recommended ○ Possible △ Not recommended

¹ Man-made leather



Airbags and belt system

The C-Class is fitted with selective front airbags plus sidebags and windowbags, all of which are activated in accordance with the type and severity of a collision. In the event of a frontal collision the electronics deploy the front airbags in two stages, depending on the severity of the accident, offering the front occupants an appropriate level of protection. The sidebags provide increased protection for the chest area, while the windowbags offer protection for the head, expanding like a curtain between the A and C-pillars. Belt tensioners on the front and on the outer rear seats pull the belts taut against the body in fractions of a second in the event of a frontal or rear-end collision of a specific



severity. The belt force limiters increase occupant safety in a frontal collision by releasing the tension in a controlled manner once a set limit has been reached. The most important retention system is the seat belt. Airbags can provide additional protection, but are subject to complex activation criteria and are not, therefore, triggered in the event of every accident. Details can be found in the Owner's Manual or the "Seat Belts and Airbags" brochure, which can be downloaded as a .pdf file (in English only) at www.mercedes-benz.com/airbag-brochure. You can also order copies from: Mercedes-Benz Customer Assistance Centre, "Airbag brochure", PO Box 14 56, 6201 BL Maastricht, Netherlands.

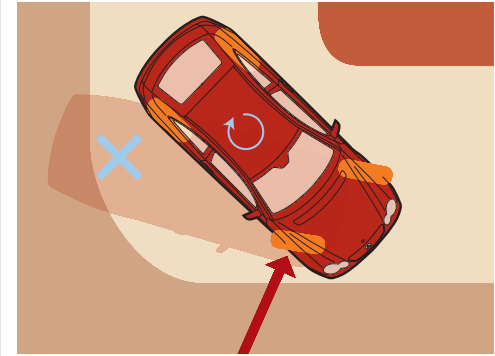

ESP® with tyre pressure loss warning system

If your car is in danger of skidding, the Electronic Stability Program (ESP®) is instantly activated. The sensors recognise critical dynamic handling situations at an early stage, e.g. the fact that a wheel is spinning or is in danger of losing contact with the road. ESP® throttles back the engine torque and brakes one or more wheels as required in order to stabilise the vehicle. The integral tyre pressure loss warning function can detect severe loss of pressure in a tyre and indicates this in the instrument cluster. It is still vital, however, that you check the tyre pressure and condition on a regular basis.

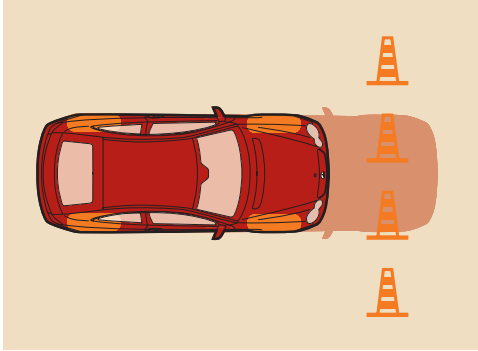

BAS

The electronic Brake Assist system recognises emergency braking by the speed with which you apply the brake and instantly builds up the maximum braking force, bringing the car to a standstill faster. Thanks to the anti-lock braking system (ABS), the wheels do not lock when automatic emergency braking is triggered and the car remains steerable. When the driver takes his or her foot off the brake pedal again, the automatic brake booster is deactivated.

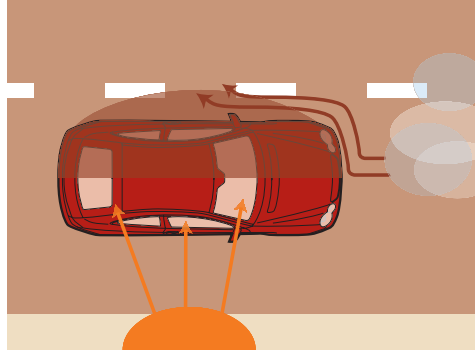

THERMOTRONIC luxury automatic climate control

The driver and front passenger can each configure their own preferred temperature and airflow settings. Sensors monitor the intensity of the sunlight, while the intake-air quality is improved by a dust filter and an activated charcoal filter. The interior temperature and blower settings are adjusted automatically to create a pleasant atmosphere. A dew-point sensor monitors air humidity to prevent the windows from misting up. The control unit's clear display makes the system simple to use.

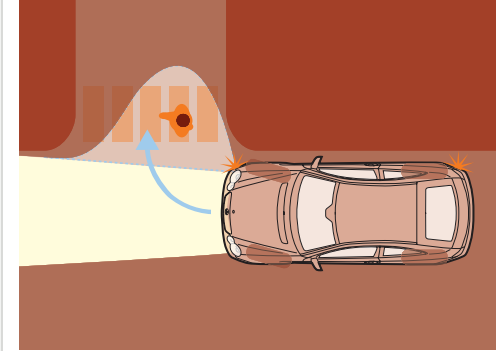

Cornering light function

The cornering light function is an extended feature of the optional bi-xenon headlamps. By dispersing the light from the fog lamp more widely, the cornering light ensures significantly better illumination of the road into which the vehicle is turning. The left or right fog lamp is activated when the headlamps are on, the vehicle speed is below 40 km/h and the indicator is on or the relevant steering angle is achieved. The cornering light function means that pedestrians and potential obstacles can be detected at an early stage and avoided.

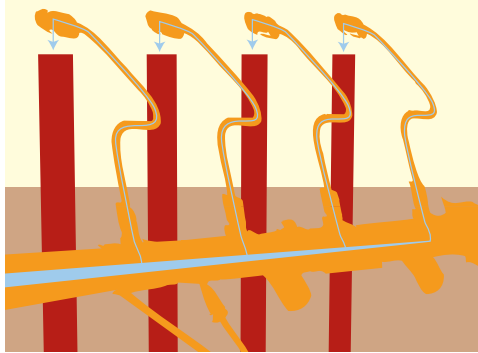

Common-rail diesel engines

Smooth and quiet operation, economy, low emissions and driving pleasure – the special qualities of the common-rail diesel engines. Responsible for this all-round talent is a common fuel supply pipe, or rail, which keeps the fuel at a permanently high pressure of around 1600 bar throughout the entire engine speed range and injects finely atomised, precisely metered quantities of fuel into the combustion chambers. The result is a reduction in fuel consumption and lower pollutant emissions. Noise emissions and engine vibration have also been significantly reduced. The good torque values are the result of, among other things, the turbocharger with a variable nozzle turbine (VNT) and the charge-air cooling.

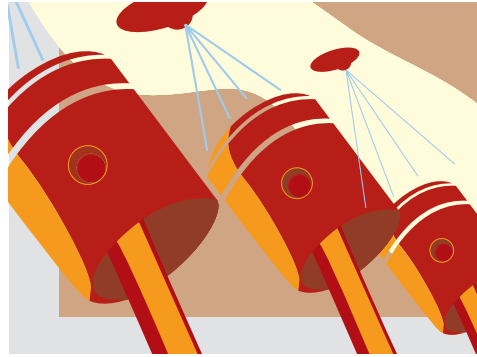

6-cylinder petrol engines with 4 valves per cylinder

4-valve technology, combined with adjustable intake and exhaust camshafts, improves the rated output and torque of the new V6 engines across a broad engine speed range. The optimised combustion chamber design also lowers fuel consumption and exhaust emissions. A balancer shaft ensures quieter engine operation and reduces vibrations.

7G-TRONIC

The world's first 7-speed automatic transmission ensures barely perceptible gearshifts, even in the upper gears. Thanks to the integral transmission control, with faster direct control of the gears, which allows several gears to be skipped, pulling power and acceleration are significantly enhanced. A second reverse gear with a higher transmission ratio makes pulling away on ice and snow safer. The seven gears make for smaller shifts in engine speed. The torque converter helps reduce consumption while enhancing acceleration. Noise emissions remain low.

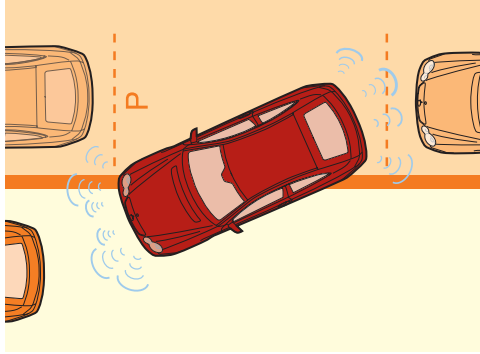

PARKTRONIC

This electronic system helps you to park and to manoeuvre your way out of a tight parking spot. Like a depth sounder, it sends out ultrasonic signals which are bounced back off obstacles in your vehicle's path. Displays in the interior show how close the vehicle is to a detected obstacle. Depending on the distance, yellow or red signals provide warnings. If the gap falls below a certain limit, PARKTRONIC also emits a continuous acoustic warning.



COMAND APS

A DVD navigation module (for most European countries) can be added to the COMAND control and display system to create COMAND APS. It works with the Global Positioning System (GPS). Enter your destination into the system, and COMAND APS works out the route. Voice instructions or direction arrows in the display tell you which way to go. Dynamic route guidance is an additional service (available in Germany and some other European countries), which uses information provided by radio stations to guide you around tailbacks where there is an alternative route.



LINGUATRONIC

To operate the telephone, the audio/video system and the navigation system, all you need is your voice and LINGUATRONIC. The system helps enhance safety since it allows you to keep both hands on the steering wheel. If LINGUATRONIC is activated, you can use a selection of easy-to-remember commands to save numbers, for example, access your phone book and make phone calls. Many other functions, such as selecting a waveband and searching for a station, can also be voice-controlled. It is now also possible to input destination details for the navigation system orally and to voice-control other functions.

Our service is your gateway to the world



www.mercedes-benz.com

Step into the world of Mercedes-Benz on-line and find out more about the brand. From its history, for example in our virtual museum to the company's latest innovations, for example in the far-sighted field of fuel cell technology. Our technology glossary keeps you up-to-date with new developments. Cars and culture? Mercedes-Benz is well-known for its sponsorship programmes, so it's only logical that we also provide you with up-to-the-minute information on motor shows, exhibitions, international fashion trends, fashion weeks and sports events. Have we awakened your interest in motorsport? Formula 1? On-line you can find all the latest results and news, and even order tickets. And of course we haven't forgotten the children. In Cedy's World there are games, a forum where your children can meet others and plenty of opportunities to learn all about cars, technology and the environment. As you can see, the virtual world can sometimes be as exciting as the real one.

MobiloLife

With MobiloLife, our mobility and warranty package, you can expect years and years of carefree driving. Whether you have lost your key, are having problems starting the car or have had a breakdown which cannot be repaired immediately, the mobility package ensures that you still reach your destination, in almost every European country. Under certain circumstances we will even meet the cost of an airline ticket. And if help takes longer than expected, we will put you up in a hotel of your choice. But don't get too excited – after all it's very rare for a Mercedes to break down. Just call Mercedes-Benz on 00800 1777 7777 from almost any European terrestrial or mobile network and our Service 24h team will assist you in your own language. Our staff are there for you around the clock, 365 days a year. Your vehicle documents provide details of the respective alternative phone numbers for each country. MobiloLife will also help if you bring your car in for a major warranty or policy repair. MobiloLife applies to a new vehicle for a period of 2 years. It is then automatically renewed every time a service is carried out by a Mercedes-Benz service centre, remaining valid until the next service is due – for a maximum of 30 years. Our service even includes a warranty against rusting through from the inside. For more detailed information on MobiloLife, see your vehicle documents.

MercedesCard

There's also a wealth of experiences to enjoy when you're not sitting at the wheel of your Mercedes-Benz. Owning a MercedesCard is all it takes. It acts as your ticket to the world of Mercedes-Benz and doubles as a practical credit card. The MercedesCard Journal contains details of a selection of sporting, cultural and travel events, put together especially for you. For further information call 00800 - 6200 3190 in Germany, 0800 - 55 79 84 in Switzerland or 0800 - 20 65 65 in Austria.

DaimlerChrysler Bank – financial services

If you have already set your heart on your dream Mercedes and want to remain flexible in financial terms, our leasing, financing and insurance packages could be exactly what you're looking for. The on-line calculator allows you to work out your monthly payments for yourself. In addition to individually geared financial services, we can also offer you tailor-made investment products. For further information call us on 0 18 03-32 22 65 (9 ct/min) or 0 18 03-DC BANK (9 ct/min) or visit www.daimlerchrysler-bank.com

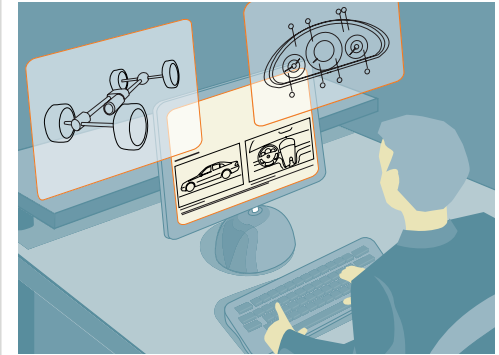

Interactive Owner's Manual

Almost as good as a test drive: the interactive Owner's Manual from Mercedes-Benz. Find out for yourself how it will feel to drive your new Mercedes – it's an experience that's only a mouse click away. Our website features informational clips and simulations designed to help you familiarise yourself with the various functions of your new car.

Discover the technical facts and figures and get a clear picture of the features that await you inside – including the multifunction steering wheel and the COMAND APS navigation system. For further details, go to www.mercedes-benz.de/betriebsanleitung



Take-back of end-of-life vehicles. Coming full circle

At the end of its long life, you can return your C-Class Sports Coupé to us for environment-friendly disposal in accordance with the EC End-Of-Life Vehicle Directive.¹
But that day lies a long way off.

¹Applies in accordance with national regulations to vehicles up to 3.5 t permissible gross weight. The C-Class Sports Coupé has met the statutory regulations governing the suitability of the vehicle's design for reuse and recycling for a number of years now. A network of vehicle take-back depots and dismantlers has been established which will process your vehicle in an environment-friendly manner. The ways in which both vehicles and parts can be recovered are subject to ongoing development and improvement. Consequently, the C-Class Sports Coupé will be able to comply with any future increases in the recycling quota within the stipulated time limits.
For further information, please call 00800 1777 7777.

Please note: changes may have been made to the product since this brochure went to press (31.07.05).
The manufacturer reserves the right to make changes to the design, form, colour and specification during the delivery period, provided these changes, while taking into account the interests of the vendor, can be deemed reasonable with respect to the purchaser. Where the vendor or the manufacturer uses symbols or numbers to describe an order or the subject of an order, no rights may be derived solely from these. The illustrations may show accessories and items of optional equipment which are not part of standard specification. Colours may differ slightly from those shown in the brochure, owing to the limitations of the printing process. This brochure has been compiled by DaimlerChrysler AG of Germany and is distributed internationally. It provides a general indication of the range of models, features, optional extras and/or colours available in various countries. Some of the models, features, optional extras and/or colours shown may not be available in your country or may only be available in a different specification. Additionally some models, features, optional extras and/or colours may only be available in combination with others. For current and more specific information in relation to the range of models, features, optional extras and/or colours available in your country, and their pricing, you should contact your nearest authorised Mercedes-Benz Passenger Car Dealer.