

Magnetic Lifter (flexible)

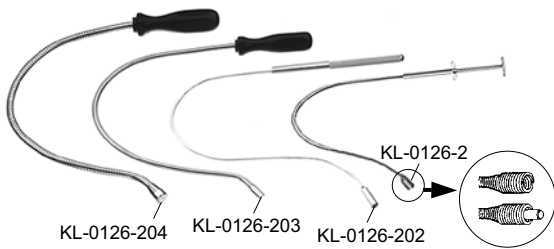

Magnetic Tools (Telescopic Design)

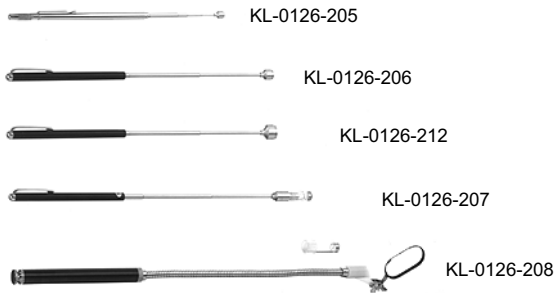

KL-0126-250

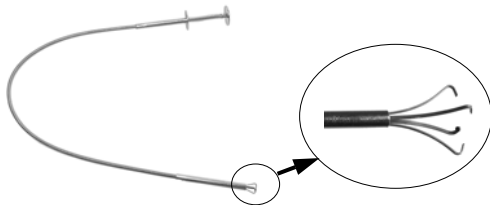

KL-0126-213

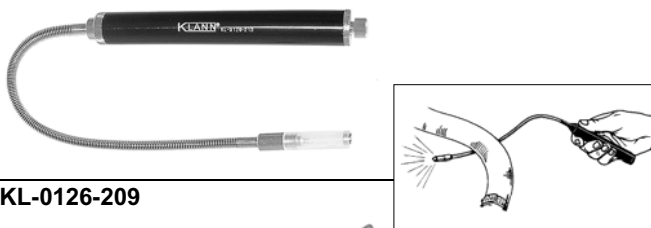

KL-0126-209



KL-0126-261



KL-0126-260



KL-0126-221



KL-0126-211

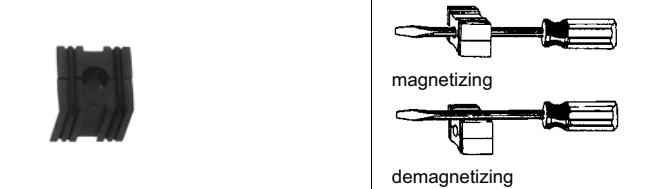

Magnetic Lifter

KL-0126-2 Magnetic Lifter with flexible Shaft

The lifting magnet is located within an anti-magnetic sleeve. This allows the tool to be positioned accurately before the magnet comes into operation. The magnet is triggered by pressing the handle which slides back the protective anti-magnetic sleeve.

KL-0126-202 Magnetic Lifter flexible (Alu)

With flexible shaft, which will remain in desired position.

KL-0126-203 Magnetic Lifter flexible

With flexible shaft - does not hold its position.

KL-0126-204 Magnetic Lifter flexible - extra strong

With flexible shaft, which will remain in desired position.

Technical Data:

Part No.	Lift effort [g]	Head-Ø [mm]	Length [mm]	Wgt. [g]
KL-0126-2	400	7	560	80
KL-0126-202	600	8	540	30
KL-0126-203	600	8	470	70
KL-0126-204	2000	15	480	140

Magnetic Lifter Telescopic Design

Part No.	Description	Liftpower [g]	Head-Ø [mm]	Length [mm]	Wgt. [g]
KL-0126-205	With scribe	300	7,5	155 - 670	28
KL-0126-206	Strong	1600	11	130 - 630	33
KL-0126-212	Extra strong Liftpower	3600	15	135 - 650	61
KL-0126-207	With light	500	11	165 - 665	40
KL-0126-208	With light and mirror	1600	14	455	167

KL-0126-250 Claw Pickup Tool

For retrieving small parts like nuts, bolts, washers, etc. from very inaccessible places. Length: 600 mm

KL-0126-213 Flexible Lamp

This flexible Lamp allows inaccessible places to be readily illuminated. The flexible shaft, on the end of which is the Lamp with a detachable magnetic head, retains all adjustments and bends.

Two 1.5 volt Mignon-Batteries are required, which are **not** included.

Total Length: 430 mm Weight (without Batteries) 120 g

Spare Parts:

KL-0126-2131 Replacement Light Assembly Set

(consists of: 5 bulbs and 1 magnetic head)

KL-0126-209 Telescopic Mirror

Allows hard to reach places to be easily seen. Used in engine inspection etc. (360° rotatable) Length: 320 / 720 mm

KL-0126-261 Telescopic Mirror

Allows hard to reach places to be easily seen. Used in engine inspection etc. (rotatable). Length: 170 / 300 mm

KL-0126-260 Telescopic Mirror

Allows hard to reach places to be easily seen. Used in engine inspection etc. (rotatable). Length: 135 / 485 mm

KL-0126-221 Magnetic Valve Key Lifter

With this flexible Mini-Magnetic Lifter metallic objects may be removed from the smallest crack.

Magnetic Lifter **KL-0126-221** is particularly suitable for removal of valve-stem collets.

Technical Data:

Length: 100 mm Weight: 6 g

Lifting Force-Ø 3 mm Magnet: 150 g Lifting Force-Ø 4 mm Magnet: 270 g

KL-0126-211 Magnetizing and Demagnetizing-Block

To magnetize and demagnetize tools.

KL-0126-302

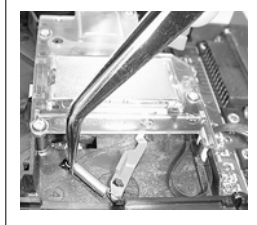

KL-0126-302 Tweezer Set

6 piece tweezer set - universal application.

Description	Length	Qty
Extra slim, fine tips	125 mm	1
Extra fine tips	115 mm	1
Extra long, rounded tips, self-locking	170 mm	1
Fine tips; 40° angled	145 mm	1
Fine tips; self-locking	120 mm	1
Special tips for instrument bulbs	115 mm	1

Weight: 140 g

KL-0126-301



KL-0126-301 Mini Hook and Pick Set

Designed to ease the removal of "O" rings, cotter pins, seals and bushes in various automotive applications. Blades stainless steel hardened and tempered with impact – resistant handles.

KL-0193-90



KL-0193-90 Pry Bar Set

Set consists of four hard wearing pry bars applicable for a number of different jobs. e.g.

- Dismantling stubborn components.
- Positioning components.
- Holder components in required position.
- Spreading clamp-fixtures, etc.

consists of:

Length	Pry Width
24" (610 mm)	20 mm
18" (460 mm)	20 mm
12" (310 mm)	16 mm
8" (200 mm)	10 mm

KL-0190-94



KL-0190-94 Pry Bar

Pry Bar made of special steel especially suitable for:

- Dismantling stubborn components.
- Positioning and holding components in required position.
- Spreading clamp-fixtures, etc.

Length: 900 mm

Blade width: 24 mm

KL-0193-95

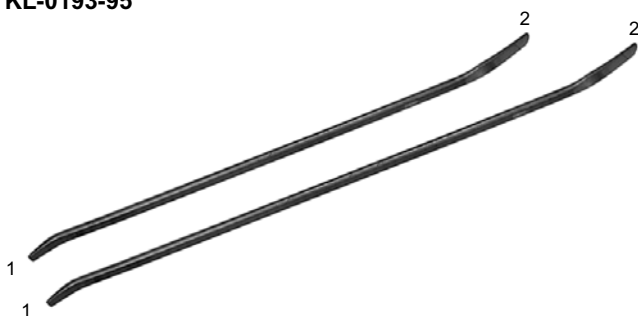

KL-0193-95 Pry Bar Set

These Pry Bars are manufactured from special steel and are particularly suitable for:

- Dismantling stubborn components.
- Positioning and holding components in required position.
- Checking ball joints and silent bearings.
- Spreading clamp-fixtures, etc.

Technical Data:

Length	Pry Width 1 / 2	Weight
730 mm	24 / 33 mm	1600 g
1050 mm	24 / 33 mm	1900 g

KL-0193-91



KL-0193-91 Mounting Lever

With chromed Blade.

Special profile ideal for Bodywork and Inner Door Trim.

Length:275 mm

Pry Width:26 mm

KL-0134-10



KL-0134-10 Arm Protector

Protects Arm from Burns While Working Around the Engine.

Made of durable, heat-resistant Kevlar®. Double wall construction for added heat protection.

Weight:57 g

KL-0126-240



KL-0126-240 Magnetic Tray

Stainless Steel Tray with extra strong rubber-protected magnetic feet.

Size:240 mm x 140 mm

KL-4901-10



KL-4901-10 Combi-Shears

High performance Blades of stainless steel for perfect cuts along the whole length of the blade. One serrated blade for cable-cutting.

Comfortable impact-resistant plastic handles with sprung self-opening action.

Blade Length40 mm

Overall Length:180 mm

KL-4902-10



KL-4902-10 Hack Saw (150 mm)

Very compact, with ergonomic Handle for delicate work in confined spaces.

For Wood, Plastic or Metal.

Blade Length:150 mm

Overall Length270 mm

Spare Part:

KL-4902-101 Replacement Blade Pack (10 pieces)

KL-0140-79



KL-0140-79 Torx® Bit and Socket Identifier

Help Select the Right Torx® Bit or Socket

A complete set of Torx® gauges will correctly identify the exact size of a Torx® nut, bolt or screw.

Set identifies Torx® bit sizes T5 through T-80, Torx® socket sizes E-1 through E-32, and tamper-proof Torx® bit sizes T-5 through T-80.

® = reg. trademark of Camcar-Textron Inc. USA

KL-0181-70 K

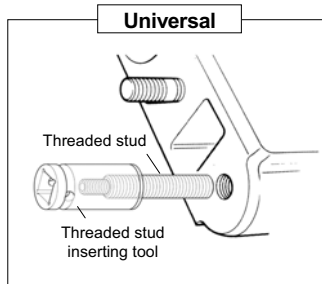

KL-0181-70 K Stud Inserting Tool Set in Plastic Case

Applicable for M6, M8, M10, M12, M8x1 and M10x1 threaded studs.

For clean, rapid insertion of threaded studs, for instance during engine repairs. *consists of:*

Part No.	Description
KL-0181-7006	Threaded stud inserting tool M6
KL-0181-7008	Threaded stud inserting tool M8
KL-0181-7010	Threaded stud inserting tool M10
KL-0181-7012	Threaded stud inserting tool M12
KL-0181-7108	Threaded stud inserting tool M8x1
KL-0181-7110	Threaded stud inserting tool M10x1
KL-4990-1004	Plastic case with foamed material liner

Technical Data:

Weight: 1250 g Drive: 1/2" □ Length: 52 mm
Measure plastic case: 275 x 230 x 83 mm

KL-0181-1

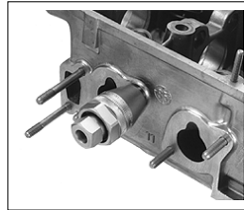

KL-0181-1 Stud Tool

Universal tool for studs with diameter 6 - 12 mm.
Suitable even for broken screws when the rest length is at least 5mm.

Advantages:

- Infinitely adjustable. • Operates in the most confined space. • Ideal also for bolts with rusted or stripped threads • Also for bolts with undersize.

KL-0181-6



KL-0181-6 Stud Extractor and Inserting Tool Set

For removal and replacement of threaded studs (left or right hand studs).

Weight: 1,15 kg Outer Drive: ... Hex. 21 mm
Inner Drive: 1/2" □

KL-0181-6 Stud Tool Set

consists of:

Part No.	Description	Part No.	Description
KL-0181-51	for Ø 6 mm	KL-0181-54	for Ø 10 mm
KL-0181-52	for Ø 7 mm	KL-0181-55	for Ø 12 mm
KL-0181-53	for Ø 8 mm	KL-0181-5001	Plastic Case

KL-0181-72 K

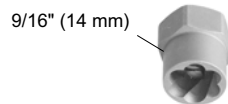

KL-0181-72 K Screw Extractor Set

To extract screws, nuts and bolts when locating threads or hexagons are damaged.

Due to the special insert design (tapered and special left section) both screws and nuts and bolts can be easily loosen and removed.

Supplied tools (insert dimensions): Drive: 3/8"
1/4" (6,3mm); 5/16" (8mm); 3/8" (9,5mm); 10mm; 7/16" (11mm);
12mm; 1/2" (12,5mm); 13mm; 9/16" (14mm); 5/8" (16mm); 17mm;
11/16" (17,5mm); 3/4" (19mm).

KL-0181-21 K

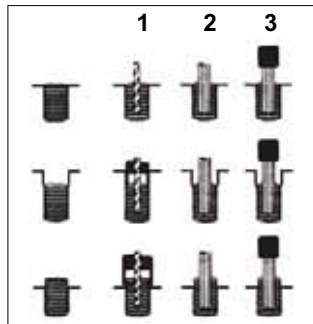

KL-0181-21 K Screw Drill Set

To remove broken screws and thread bolts - thread M5 - M16.

Procedure: 1. Open the broken bolt (or screw) by drilling (use boring bush if necessary). 2. Drive in the pin. 3. Place the nut on the pin and extract by means of a screw-wrench.

Spare Parts/Accessories:

Part No.	Description	Qty.
KL-0181-2112	Drilled pin set for driller Ø: 3,2 mm (5.Pcs.)	1
KL-0181-2122	Drilled pin set for driller Ø: 4,8 mm (5.Pcs.)	1
KL-0181-2132	Drilled pin set for driller Ø: 6,4 mm (5.Pcs.)	1
KL-0181-2142	Drilled pin set for driller Ø: 8,0 mm (5.Pcs.)	1
KL-0181-2152	Drilled pin set for driller Ø: 8,8 mm (5.Pcs.)	1

KL-0140-41

KL-0140-40



Note: The Frame Micrometers KL-0140-40 and KL-0140-41 are delivered in storage boxes.

Frame Micrometers

With ratchet and clamping-ring, enclosed thread, spindle hardened and adjustable, with hand guard insulating pads, reading parts chrome plated, with check-gauge. Description: Chrome-plated.

KL-0140-40 Frame Micrometer

Range: 0-25 mm Pitch: 1/2 mm Weight: 350 g

KL-0140-41 Frame Micrometer

Range: 25-50 mm Pitch: 1/2 mm Weight: 500 g

KL-0128-1 KL-0128-0 KL-0128-25

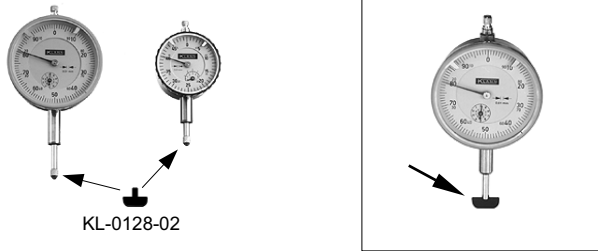

KL-0140-50



KL-0128-31



KL-0140-36



KL-0128-1 Dial Indicator \varnothing 58 mm

Description: Stem and spindle stainless steel, accuracy to DIN 878-A.
 Reading: 0,01 mm
 Measuring Range: 10 mm
 Housing \varnothing : 58 mm
 Set nut revolution by 360: 1 mm
 Stem \varnothing : 8 h 6

KL-0128-0 Dial Indicator \varnothing 40 mm

Description: Stem and spindle stainless steel, accuracy to DIN 878-E.
 The dial indicator is additionally equipped with an extension of 10 mm (KL-0128-03).
 Reading: 0,01 mm
 Measuring Range: 5 mm
 Housing \varnothing : 40 mm
 Set nut revolution by 360: 0,5 mm
 Stem \varnothing : 8 h 6

KL-0128-25 Extension Set

For Dial Indicators KL-0128-0 & KL-0128-1. Each extension with diameter 4 mm. The set consist of extensions KL-0128-03 to KL-0128-21.

Part No.	Length	Part No.	Length	Part No.	Length
KL-0128-03	10 mm	KL-0128-10	45 mm	KL-0128-17	80 mm
KL-0128-04	15 mm	KL-0128-11	50 mm	KL-0128-18	85 mm
KL-0128-05	20 mm	KL-0128-12	55 mm	KL-0128-19	90 mm
KL-0128-06	25 mm	KL-0128-13	60 mm	KL-0128-20	95 mm
KL-0128-07	30 mm	KL-0128-14	65 mm	KL-0128-21	100 mm
KL-0128-08	35 mm	KL-0128-15	70 mm	Accessory: KL-0128-02	
KL-0128-09	40 mm	KL-0128-16	75 mm	Flat Measuring Pin	

KL-0128-02 Flat Measuring Pin

As an accessory for the shown Dial Indicators KL-0128-1 (\varnothing 58 mm) or KL-0128-0 (\varnothing 40 mm).

KL-0140-50 Precision-Inside-Measuring-Tool

Dial gauge for measuring of cylindrical bores, especially for petrol and diesel engines. Includes dial-gauge and wooden case.
 Measuring range: \varnothing 50-178 mm
 Measuring depth: 180 mm

KL-0128-31 Dial Gauge with Stands and Dial Indicator

Consists of KL-0128-1 and KL-0128-3.
 Strong rods of tool-steel, with fine adjustment for dial-gauge-clamp, prismatic magnetic base. Inclusive Dial Indicator \varnothing 58 mm and Wooden Case.

- To measure the distortion of the brake disc.
- For adjusting the engine and transmission.

KL-0128-3 Dial Gauge without Dial Indicator

As KL-0128-31, but without Dial Gauge indicator.

KL-0140-36 Slide Caliper digital

Open slide, hardened, with cross-points and depth gauge.
 Description: stainless steel.
 Range: 155 mm
 Jaw Length: 40 mm
 Vernier: 0,01 mm
 Weight: 200 g

KL-0140-32

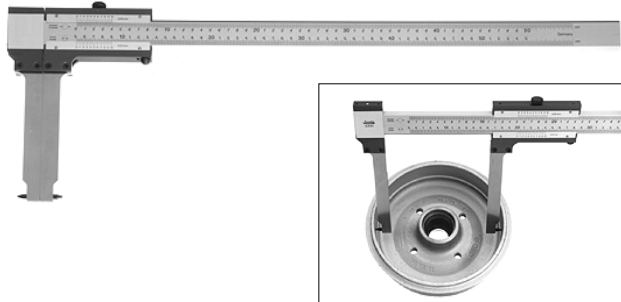

KL-0140-32 Slide Caliper for Brake Drum

Measuring-surfaces stainless steel, rule and slide produced of aluminium-profile, open slide, fixing-screw, vernier parallax free reading.

Range:..... 500 mm Jaw Length:..... 250 mm
 Vernier: . 1/20 mm + 1/128" Weight: 1200 g

KL-0140-33

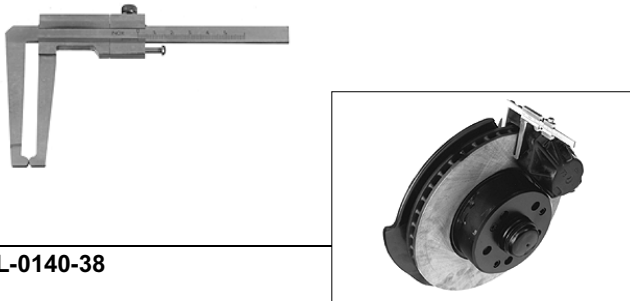

KL-0140-33 Slide Caliper for Brake Disc

To measure the thickness of installed brake-discs. The tool is hardened and contains a locking screw.

Design:stainless-steel Jaw Length:..... 75 mm
 Range:..... 50 mm Weight: 110 g
 Vernier: 1/10 mm

KL-0140-38



KL-0140-38 Slide Caliper for Brake Disc

To measure the thickness of installed brake-discs. The tool is hardened and contains a locking screw.

Design: Stainless-steel Jaw Length:..... 120 mm
 Range:..... 100 mm Weight: 240 g
 Vernier: 1/10 mm

KL-0140-74

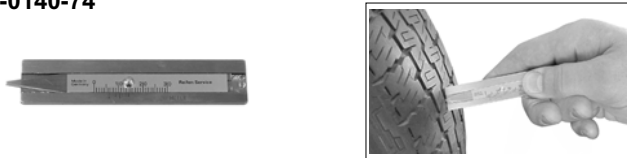

KL-0140-74 Tyre Tread Depth Gauge

Strong brass construction.

Range:..... 30 mm Legible accuracy: 0,1 mm
 Vernier: 50 g

KL-0140-76



KL-0140-76 Feeler Gauge (20 Blade)

Range:..... 0,05-1,00 mm in 0,05 mm increments.
 Blade-Length:..... 100 mm Weight: 100 g

KL-0140-60

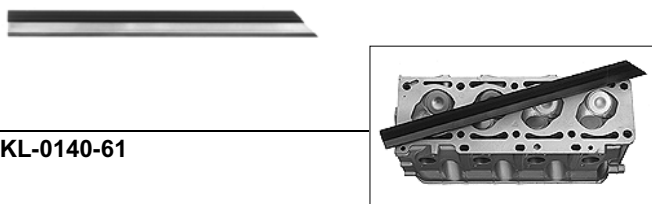

KL-0140-60 Precision-Hair-Edges 500 mm

Hair-edges hardened, ground, lapped, with heat-insulated handle. For fitting Cylinder Heads up to 4 Cylinders.

Design:stainless steel Section: 40 x 7 mm
 Length: 500 mm Weight: 960 g

KL-0140-61



KL-0140-61 Precision-Hair-Edges 600 mm

As **KL-0140-60** but for fitting Cylinder Heads up to 6 Cylinders.

Length: 600 mm Weight: 1200 g

KL-0140-6101 Wooden Storage Case for Precision-Hair-Edges

For storing the Precision-Hair-Edges **KL-0140-60** or **KL-0140-61** (not ill.).

Length: 625 mm Weight: 400 g

KL-0192-5

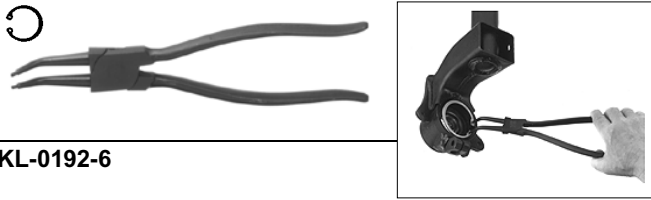

KL-0192-6

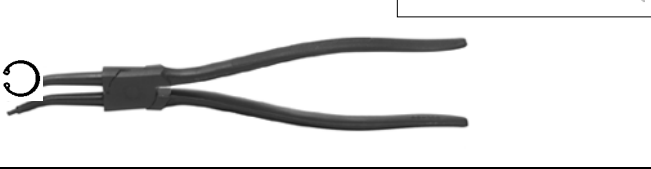

KL-0192-82 K

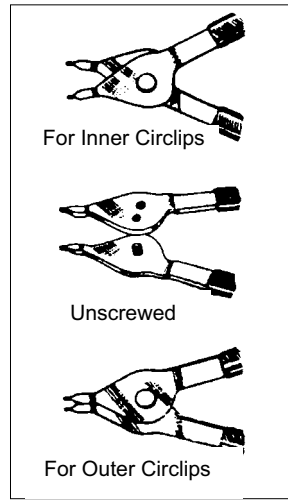
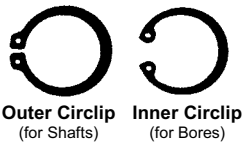

Pliers for Special Safety Rings

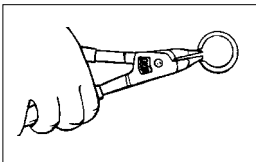

KL-0192-823



KL-0192-824



KL-0192-825



KL-0192-826

KL-0192-5 Circlip Pliers \varnothing 40-100 mm

45° angled Tips make these Pliers ideal for inner-rings when repairing Gearboxes.

Tip- \varnothing : 2,3 mm
Length: 220 mm

KL-0192-6 Circlip Pliers \varnothing 85-165 mm

The special form of the Tips (45° off-set) allows quick and easy removal and replacement of Inner-rings during wheel-bearing repairs

Tip- \varnothing : 3,3 mm
Length: 315 mm

KL-0192-82 K Circlip Pliers Set

10-piece Set, consisting of 8 Pliers and 2 Hooks
Pliers reversible for inner or outer Circlips with captive screw.

- Pliers reversible for inner or outer Circlips
- Pliers straight and angled
- Pliers with easy-grip handles
- Pliers of heat-treated spring-steel
→ light and handy
- Hooks straight and angled

Total weight: 1.800 g

Technical Data:

Tip Form	Tip \varnothing [mm]	for Shaft \varnothing or Bore \varnothing [mm]	Length [mm]	Weight [g]
straight	1,0	3 - 10 / 8 - 25	150	65
angled	1,0	3 - 10 / 8 - 25	145	65
straight	1,3	10 - 25	150	65
angled	1,3	12 - 25	145	65
straight	1,8	19 - 60 / 19 - 60	195	120
angled	1,8	19 - 60 / 19 - 60	190	120
straight	2,3	40 - 100 / 40 - 100	235	220
angled	2,3	40 - 100 / 40 - 100	230	220

The Set is delivered in a Plastic Storage Case.

Pliers for Special Safety Rings

Part-No.	Application example	Tip-Form	Tip size [mm]	Long [mm]	Wgt. [g]
KL-0192-823	Large Rings on Drive Shafts in earth-movers and construction vehicles	Inter-change, wide, milled	3,5 × 8 spreading 8 - 75	330	490
KL-0192-824	Large Rings on Drive Shafts and steering racks, e.g. Opel/Vauxhall, VW-Audi	straight, pointed, short, milled	1,6 × 3,3 spreading 3,5 - 26	210	190
KL-0192-825	Deep, large Rings on Drive Shafts and Steering Shafts	straight, centerin g-rand, long, slim	2,4 × 4,2 spreading 5 - 40	240	210
KL-0192-826	Large Rings on Drive Shafts and Steering Shafts e.g. VW-Audi	straight with Hold profile	4 × 3,5 spreading 6,5 - 35	225	205

KL-0192-11

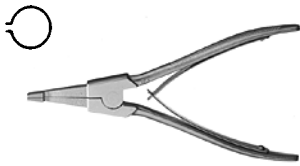

KL-0192-11 Circlip Pliers straight

Suitable for **VW-Audi, Mercedes, Opel**, etc.

Tips are angled to 90°. The Pliers allow quick and easy removal and replacement of Outer-Rings during repairs to Motors, Transmissions, Differentials, Steering, etc.

KL-0192-12

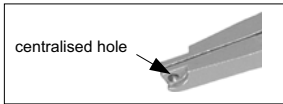
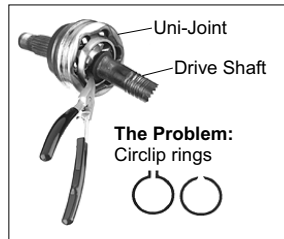

KL-0192-12 Circlip Pliers angled 30°

Suitable for **VW-Audi, Mercedes, Opel**, etc.

The Tips are angled at 30°, and are very thin with an additional centralised hole in the face of the Tip, which guarantees safe grip on Outer Rings. This is particularly important during repairs to Drive-Shafts/CV Joints, Motors and Transmissions.

KL-0192-7



KL-0192-7 Circlip Pliers angled 90°

For brake calipers and transmission, angled 90°.

Length: 190 mm

Length of Flange: 60 mm

KL-0192-24



KL-0192-24 Needle Nose Pliers straight (long version)

With extra long grip, for difficult to get to positions.

Length: 280 mm

KL-0192-25



KL-0192-25 Needle Nose Pliers angled 45° (long version)

With extra long grip, angled 45°, for difficult to get to positions.

Length: 280 mm

KL-4443-Series



KL-4103-210

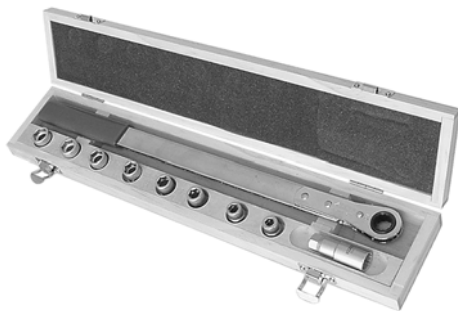
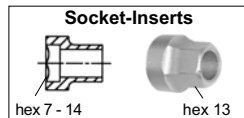

KL-4417-900

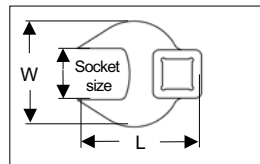

KL-0169-318 / KL-0169-321

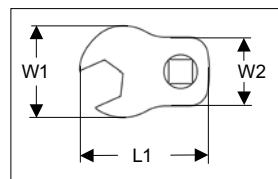
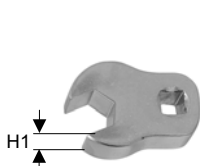

KL-4443-901 Double Ring Spanner Set Torx® (4 pcs.)

Special Chrome Vanadium Steel. matt chrome finish.

consists of:

Part-No.	Description
KL-4443-0608	Double Ring Spanner Torx E6 / E8
KL-4443-1012	Double Ring Spanner Torx E10 / E12
KL-4443-1418	Double Ring Spanner Torx E14 / E18
KL-4443-2024	Double Ring Spanner Torx E20 / E24

® = reg. trademark of Camcar-Textron Inc. USA

KL-4103-210 Special Socket Set

For quick and easy loosening and tightening of nuts and bolts in difficult to reach locations.

Advantages:

- Sockets with central bore for such applications as Studs, Hand Brake Cables, etc.
- Long Ratchet Handle, with very low profile (24 mm incl. socket), for use in very restricted spaces.
- Reversible direction - Left and Right.

Weight:..... 950 g

Contents:

Part No.	Description	Size	Drive	Length	Qty.
KL-4103-2013	Ratchet Ring Spanner long		13 mm	400 mm	1
KL-4103-2107	Socket	7 mm	13 mm	20 mm	1
KL-4103-2108	Socket	8 mm	13 mm	20 mm	1
KL-4103-2109	Socket	9 mm	13 mm	20 mm	1
KL-4103-2110	Socket	10 mm	13 mm	20 mm	1
KL-4103-2111	Socket	11 mm	13 mm	20 mm	1
KL-4103-2112	Socket	12 mm	13 mm	20 mm	1
KL-4103-2113	Socket	13 mm	13 mm	20 mm	1
KL-4103-2114	Socket	14 mm	13 mm	20 mm	1
KL-4103-2150	Socket extension	13 mm	13 mm	50 mm	1
KL-4103-2190	Wooden case				1

KL-4417-900 Crow Foot Spanner Set

Special Chrome Vanadium Steel

Matt chrome finish

Drive:.....3/8"□

Specially designed to loosen and tighten nuts and bolts in confined spaces - e.g. Fuel Injector connections.

consists of:

Part No.	Description	Socket size	Width (W)	Length (L)	Weight (g)
KL-4417-16	Crow Foot Spanner	16 mm	34 mm	40 mm	40 g
KL-4417-17	Crow Foot Spanner	17 mm	35 mm	42 mm	50 g
KL-4417-18	Crow Foot Spanner	18 mm	37 mm	45 mm	60 g
KL-4417-19	Crow Foot Spanner	19 mm	41 mm	48 mm	70 g
KL-4417-21	Crow Foot Spanner	21 mm	43 mm	51 mm	80 g

KL-0169-318 Open Ended Spanner Socket

Suitable for Steering Rack Opel Vectra B, etc.

Extra-strong version, ideal for unscrewing or turning track rods.

Drive:.....1/2" □

Part-No.	Hex	Length [L1]	Height [H1]	Width 1 [W1]	Width 2 [W2]	Weight [g]
KL-0169-318	18	70 mm	20 mm	45,5 mm	32 mm	300

KL-0169-321 Open Ended Spanner Socket

As **KL-0169-318** but with hex 21 mm e.g. suitable for Steering Rack Opel Sintra, etc.

Drive:.....1/2" □

Part-No.	Hex	Length [L1]	Height [H1]	Width 1 [W1]	Width 2 [W2]	Weight [g]
KL-0169-321	21	70 mm	20 mm	49,5 mm	37 mm	330

KL-4072-301

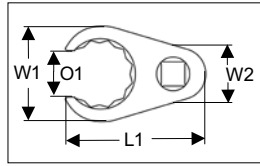
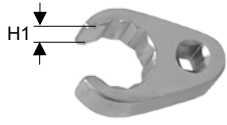

1/2"

KL-4072-302

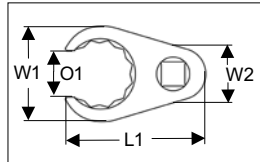
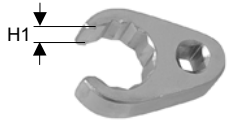

1/2"

KL-4072-401

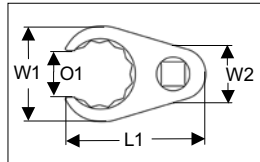
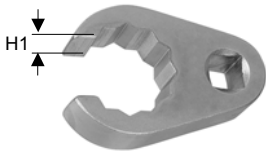

3/4"

KL-4072-321



1/2"

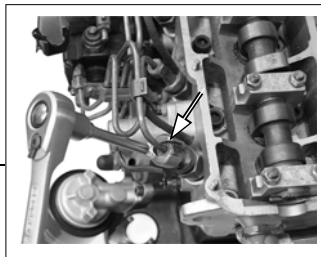

KL-4071-311

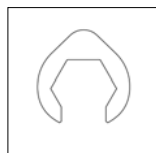

1/2"

KL-4072-301 Open ended ring spanner Socket Set

Open 12-sided spanners are exceptionally compact and strong, so that even screws and nuts that are difficult to reach or turn can be loosened and tightened. Drive: 1/2" □

consists of:

Part-No.	Hex (mm)	Length [L1]	Height [H1]	Width 1 [W1]	Width 2 [W2]	Opening [O1]	Weight [g]
KL-4072-3017	17	60 mm	20 mm	31 mm	31 mm	12 mm	150
KL-4072-3018	18	63 mm	20 mm	34 mm	31 mm	14 mm	150
KL-4072-3019	19	63 mm	20 mm	34 mm	31 mm	14 mm	150
KL-4072-3022	22	65 mm	25 mm	39 mm	31 mm	15,5 mm	325
KL-4072-3024	24	70 mm	25 mm	44 mm	31 mm	18 mm	350

KL-4072-302 Open ended ring spanner Socket Set

As KL-4072-301, but

Drive: 1/2" □

consists of:

Part-No.	Hex (12-point)	Length [L1]	Height [H1]	Width 1 [W1]	Width 2 [W2]	Opening [O1]	Weight [g]
KL-4072-3027	27	74 mm	25 mm	48 mm	34 mm	20 mm	360
KL-4072-3030	30	76 mm	25 mm	50 mm	34 mm	22,5 mm	360
KL-4072-3032	32	80 mm	25 mm	52 mm	34 mm	25 mm	360

KL-4072-401 Open ended ring spanner Socket Set

As KL-4072-301, but

Drive: 3/4" □

consists of:

Part-No.	Hex (12-point)	Length [L1]	Height [H1]	Width 1 [W1]	Width 2 [W2]	Opening [O1]	Weight [g]
KL-4072-3036	36	106 mm	30 mm	66 mm	48 mm	26,5 mm	785
KL-4072-3041	41	110 mm	30 mm	70 mm	48 mm	29 mm	835
KL-4072-3046	46	115 mm	30 mm	75 mm	48 mm	33 mm	905

KL-4072-321 Open ended ring wrench Socket Set

Specially designed to loosen and tighten nuts and bolts in confined spaces - e.g. Fuel Injector connections.

Technical Data: Drive: 1/2" □ Length: 100 mm

consists of:

Part-No.	Hex (12-point)	Description
KL-4072-3214	14	Open Ended ring wrench Socket
KL-4072-3216	16	Open Ended ring wrench Socket
KL-4072-3217	17	Open Ended ring wrench Socket
KL-4072-3218	18	Open Ended ring wrench Socket
KL-4072-3219	19	Open Ended ring wrench Socket

KL-4071-311 Open ended ring wrench Socket Set

As KL-4072-321 but as hex wrench and 80 mm long.

Technical Data:

Length: 80 mm

consists of:

Part-No.	Hex. (6-point)	Drive 3/8"	Drive 1/2"	Description
KL-4071-3112	12	X		Open Ended ring wrench Socket
KL-4071-3114	14	X		Open Ended ring wrench Socket
KL-4071-3116	16		X	Open Ended ring wrench Socket
KL-4071-3117	17	X		Open Ended ring wrench Socket
KL-4071-3118	18		X	Open Ended ring wrench Socket
KL-4071-3119	19		X	Open Ended ring wrench Socket

10

KL-4220-111

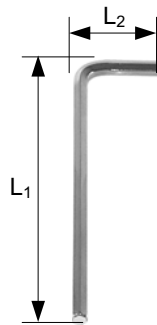

KL-4220-131

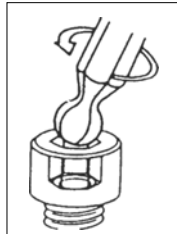
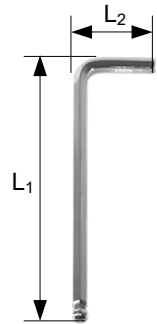

KL-4240-101

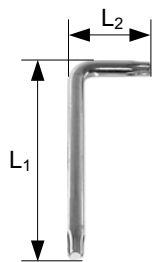

KL-4240-111

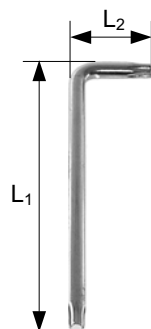

KL-4220-101 Allen Key Set short (with collapsible holder)

10 pcs. Surface chrome (not illustrated) Weight:..... 300 g

Hex (mm)	Length L ₁	Length L ₂
1,5	47 mm	16 mm
2	52 mm	18 mm
2,5	58 mm	20 mm
3	66 mm	22 mm
4	74 mm	27 mm
5	85 mm	32 mm
6	96 mm	37 mm
8	108 mm	44 mm
10	122 mm	51 mm

KL-4220-111 Allen Key Set long (with collapsible holder)

10 pcs. Surface chrome Weight:..... 390 g

Hex (mm)	Length L ₁	Length L ₂
1,5	78 mm	16 mm
2	83 mm	18 mm
2,5	90 mm	20 mm
3	99 mm	22 mm
4	109 mm	27 mm
5	120 mm	32 mm
6	139 mm	37 mm
8	162 mm	41 mm
10	180 mm	47 mm

KL-4220-131 Allen "Ball" Key Set long (with collapsible holder)

10 pcs. Surface chrome Weight:..... 390 g

Hex (mm)	Length L ₁	Length L ₂
1,5	78 mm	16 mm
2	83 mm	18 mm
2,5	90 mm	20 mm
3	99 mm	22 mm
4	109 mm	27 mm
5	120 mm	32 mm
6	139 mm	37 mm
8	162 mm	41 mm
10	180 mm	47 mm

KL-4240-101 Torx® Key Set short (with collapsible holder)

11 pcs. Surface chrome Weight:..... 300 g

Torx®	Length L ₁	Length L ₂
T9	58 mm	21 mm
T10	62 mm	23 mm
T15	68 mm	25 mm
T20	73 mm	27 mm
T25	77 mm	29 mm
T27	83 mm	30 mm
T30	88 mm	32 mm
T40	96 mm	35 mm
T45	104 mm	40 mm
T50	114 mm	44 mm

KL-4240-111 Torx® Key Set long (with collapsible holder)

11 pcs. Surface chrome Weight:..... 370 g

Torx®	Length L ₁	Length L ₂
T9	82 mm	19 mm
T10	88 mm	20 mm
T15	93 mm	22 mm
T20	99 mm	23 mm
T25	104 mm	25 mm
T27	110 mm	26 mm
T30	120 mm	30 mm
T40	131 mm	33 mm
T45	145 mm	37 mm
T50	180 mm	41 mm

® = reg. trademark of Camcar-Textron Inc. USA

KL-4310-101 K

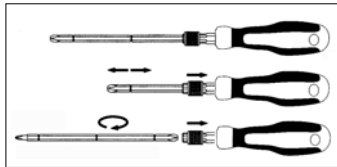
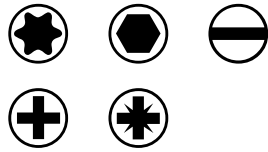

KL-4310-101 K Screwdriver Set with inter-changeable blades

In plastic case.

The handle has a 1/4" Blade Receiver and a hexagonal drive 10 mm.
The blades are lockable at lengths of 80 and 135 mm.

- ⊕ Torx® sizes : T10, T15, T20, T25, T30 and T40.
- ⦿ Hex sizes : 3, 4, 5 and 6
- Straight sizes: 4, 5, 6 and 7
- ⊕ Phillips sizes: PH.1, PH.2 and PH.3
- ⊕ Pozidriv sizes: PZ.1, PZ.2 and PZ.3

Weight:..... 660 g

KL-4305-621



KL-4305-621 Torx® Screwdriver Set (6 pcs.)

The long, slim design of the shaft allows deep-set Torx® Bolts to be reached without problem.

Consists of: T10, T15, T20, T25, T27, T30

Shaft Ø: **T10 (4,5 mm); T15 (4,5 mm); T20 (4,5 mm);**
T25 (4,5 mm), T27 (5 mm); T30 (5,5 mm).

Shaft Length:..... 200 mm Overall length:..... 300 mm

Specially used for:

- T20** removal and replacement of door-handles on **Mercedes A- and C-Class.**
- T25** removal and replacement of **headlamps** on **VW Sharan** model year 2000 - onwards.
- T30** for front wing bolts on **BMW 7 series (E38)**, also removal and replacement of **headlamps** on **Audi A6.**

KL-4306-631

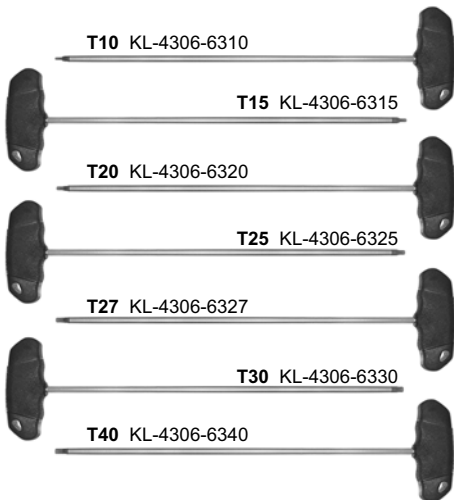

KL-4306-631 Torx® T-Handle Screwdriver Set (7 pcs.)

The long, slim design of the shaft allows deep-set Torx® Bolts to be reached without problem.

Shaft satin chrome finish with black tips.

Consists of: T10, T15, T20, T25, T27, T30, T40

Shaft Ø: **T10 (6 mm); T15 (6 mm); T20 (6 mm); T25 (6 mm),**
T27 (6 mm); T30 (6 mm); T40 (7 mm)

Shaft Length:..... 350 mm Overall length:..... 385 mm

Specially used for:

- T30** For front wing bolts on **BMW 7 series (E38)**, also removal and replacement of headlamps on **Audi A6.**
- T30/T40** For removal and replacement of oil-ump on **VW-Audi.**

© = reg. trademark of Camcar-Extron Inc. USA

KL-4306-8320



Mercedes

5-Point

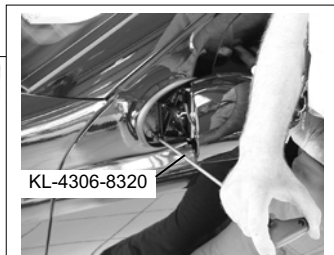

KL-4306-8320

KL-4306-8320 T-Handle Screwdriver 5-Points (T20 x 260 mm)

Suitable for Mercedes.

The long and narrow shape of the **KL-4306-8320** 5-point screwdriver makes it ideal for removing and installing outside mirrors on Mercedes vehicles.

Note: (the following fastening screws are used on Mercedes vehicles with the outside mirror shown here)

OEM = Torx® T20 (KL-4306-6320) or 5-point T20
MB spare part = 5-point T20

Weight:..... 100 g Size: T20
Shaft Length:..... 255 mm Overall length:..... 295 mm

KL-4347-830



KL-4347-830 Torx® Screwdriver Set (6 pcs.)

Chrome-vanadium-Steel.

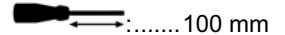

consists of:

Part-No.	Description	Qty
KL-4347-8304	Torx® Screwdriver E4 x 100 mm	1
KL-4347-8305	Torx® Screwdriver E5 x 100 mm	1
KL-4347-8306	Torx® Screwdriver E6 x 100 mm	1
KL-4347-8307	Torx® Screwdriver E7 x 100 mm	1
KL-4347-8308	Torx® Screwdriver E8 x 100 mm	1
KL-4347-8310	Torx® Screwdriver E10 x 100 mm	1

® = reg. trademark of Camcar-Textron Inc. USA

KL-4004-240 K



KL-4004-240 K Bit Insert Set Torx® / XZN / 10 mm Hex

Consists of:

KL-4004-229 Bit-Holder, 10 mm hex; Drive 3/8" the carrier of the Inserts.

KL-4004-329 Bit-Holder, 10 mm hex; Drive 1/2" the carrier of the Inserts.

Bit Inserts, Drive 10 mm hex; Length 30 mm

Part-No.	Size (hex)	Part-No.	Size (hex)
KL-4024-7004	hex 4	KL-4024-7008	hex 8
KL-4024-7005	hex 5	KL-4024-7010	hex 10
KL-4024-7006	hex 6	KL-4024-7012	hex 12
KL-4024-7007	hex 7		

Part-No.	Size	Part-No.	Size
KL-4034-7005	M5	KL-4034-7010	M10
KL-4034-7006	M6	KL-4034-7012	M12
KL-4034-7008	M8		

Part-No.	Size	Part-No.	Size
KL-4044-7020	T20	KL-4044-7045	T45
KL-4044-7025	T25	KL-4044-7050	T50
KL-4044-7030	T30	KL-4044-7055	T55
KL-4044-7040	T40	KL-4044-7060	T60

Bit Inserts, Drive 10 mm hex; Length 75 mm

Part-No.	Size (hex)	Part-No.	Size (hex)
KL-4024-7104	hex 4	KL-4024-7108	hex 8
KL-4024-7105	hex 5	KL-4024-7110	hex 10
KL-4024-7106	hex 6	KL-4024-7112	hex 12
KL-4024-7107	hex 7		

Part-No.	Size	Part-No.	Size
KL-4034-7105	M5	KL-4034-7110	M10
KL-4034-7106	M6	KL-4034-7112	M12
KL-4034-7108	M8		

Part-No.	Size	Part-No.	Size
KL-4044-7120	T20	KL-4044-7145	T45
KL-4044-7125	T25	KL-4044-7150	T50
KL-4044-7130	T30	KL-4044-7155	T55
KL-4044-7140	T40	KL-4044-7160	T60

KL-4004-2490 Plastic case (empty) for KL-4004-240 K

KL-4004-229 (3/8"□)



KL-4004-329 (1/2"□)



KL-4024-70.. (30mm)



KL-4024-71.. (75 mm)



KL-4034-70.. (30mm)



KL-4034-71.. (75 mm)



KL-4044-70.. (30 mm)



KL-4044-71.. (75 mm)



KL-4040-100 K

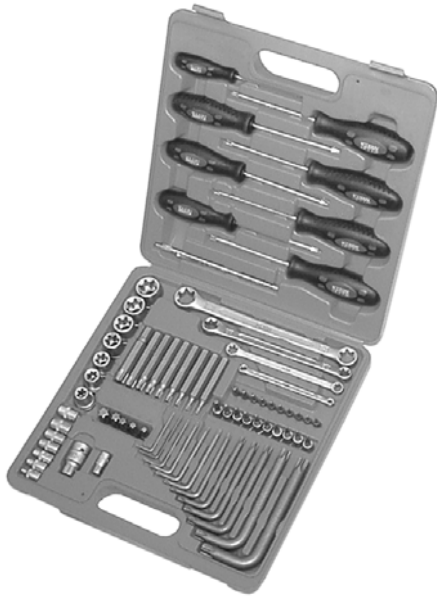

Specification:

Magnetic Lifter with scriber



Screwdrivers



Double Ring Spanners



Sockets, Drive 1/2"□



Bit-Holder, Drive 1/2"□ auf hex 10



Bit-Inserts, Driver hex 10



Sockets, Driver 1/4"□



Bit-Holder, Driver 1/4"□ auf hex 1/4"



Bit-Inserts, Driver hex 1/4"



Torx® Keys



KL-4040-100 K Torx® Tool Set

Consists of:

Magnetic Lifter KL-0126-205:

Head-Ø 7,5 mm; 155 - 675 mm; Weight 28 g; lift-capacity 400 g

Screwdrivers:

Part-No.	Size	Part-No.	Size
KL-4040-1208	T8 x 80 mm	KL-4040-1225	T25 x 100 mm
KL-4040-1210	T10 x 100 mm	KL-4040-1227	T27 x 100 mm
KL-4040-1215	T15 x 100 mm	KL-4040-1230	T30 x 100 mm
KL-4040-1220	T20 x 100 mm	KL-4040-1240	T40 x 100 mm

Double Ring Spanners:

Part-No.	Size	Part-No.	Size
KL-4443-0608	E6 / E8	KL-4443-1418	E14 / E18
KL-4443-1012	E10 / E12	KL-4443-2024	E20 / E24

Sockets Drive 1/2"□, Length 38 mm

Part-No.	Size	Part-No.	Size
KL-4040-1012	Torx® E12	KL-4040-1020	Torx® E20
KL-4040-1014	Torx® E14	KL-4040-1022	Torx® E22
KL-4040-1016	Torx® E16	KL-4040-1024	Torx® E24
KL-4040-1018	Torx® E18		

Bit-Holder hex10 KL-4004-329 Drive 1/2"□

Bit-Inserts Drive hex 10; Length 30 mm

Part-No.	Size	Part-No.	Size
KL-4044-7040	Torx® T40	KL-4044-7055	Torx® T55
KL-4044-7045	Torx® T45	KL-4044-7060	Torx® T60
KL-4044-7050	Torx® T50		

Bit-Inserts Drive hex 10; Length 75 mm

Part-No.	Size	Part-No.	Size
KL-4044-7115	Torx® T15	KL-4044-7145	Torx® T45
KL-4044-7120	Torx® T20	KL-4044-7150	Torx® T50
KL-4044-7125	Torx® T25	KL-4044-7155	Torx® T55
KL-4044-7130	Torx® T30	KL-4044-7160	Torx® T60
KL-4044-7140	Torx® T40		

Sockets Drive 1/4"□, Length 23 mm

Part-No.	Size	Part-No.	Size
KL-4047-6004	Torx® E4	KL-4047-6008	Torx® E8
KL-4047-6005	Torx® E5	KL-4047-6010	Torx® E10
KL-4047-6006	Torx® E6	KL-4047-6011	Torx® E11
KL-4047-6007	Torx® E7		

Socket Inserts Drive 1/4"□, Length 38 mm

Part-No.	Size	Part-No.	Size
KL-4041-1007	Torx® T7	KL-4041-1020	Torx® T20
KL-4041-1008	Torx® T8	KL-4041-1025	Torx® T25
KL-4041-1009	Torx® T9	KL-4041-1027	Torx® T27
KL-4041-1010	Torx® T10	KL-4041-1030	Torx® T30
KL-4041-1015	Torx® T15		

Bit-Holder hex 1/4" KL-4004-129 Drive 1/4"□

Bit-Inserts Drive hex 1/4"

Part-No.	Size	Part-No.	Size
KL-4045-1007	Torx® T7B	KL-4045-1020	Torx® T20B
KL-4045-1008	Torx® T8B	KL-4045-1025	Torx® T25B
KL-4045-1009	Torx® T9B	KL-4045-1027	Torx® T27B
KL-4045-1010	Torx® T10B	KL-4045-1030	Torx® T30B
KL-4045-1015	Torx® T15B	KL-4045-1040	Torx® T40B

Torx® Keys

Part-No.	Size	Part-No.	Size
KL-4241-1008	Torx® T8	KL-4241-1030	Torx® T30
KL-4241-1010	Torx® T10	KL-4241-1040	Torx® T40
KL-4241-1015	Torx® T15	KL-4241-1045	Torx® T45
KL-4241-1020	Torx® T20	KL-4241-1050	Torx® T50
KL-4241-1025	Torx® T25	KL-4241-1055	Torx® T55
KL-4241-1027	Torx® T27	KL-4241-1060	Torx® T60

KL-4040-1090 Plastic case, for KL-4040-100 K (empty).

© = reg. trademark of Camcar-TeXtron Inc. US

KL-4044-701 K



KL-4004-229 (3/8"□)



KL-4004-329 (1/2"□)



KL-4044-70.. (30 mm)



KL-4044-71.. (75 mm)



KL-4047-60.. (23 mm)



KL-4047-20.. (23 mm)



KL-4045-35.. (40 mm)



KL-4054-701 K



KL-4004-229 (3/8"□)



KL-4004-329 (1/2"□)



KL-4054-70.. (30mm)



KL-4054-71.. (75 mm)



KL-4044-701 K Socket Insert Set Torx®

Consists of:

KL-4004-229 Bit-Holder, ⌀ hex 10 mm; Drive 3/8"□ carrier for the screwdriver Inserts.

KL-4004-329 Bit-Holder, ⌀ hex 10 mm; Drive 1/2"□ carrier for the screwdriver Inserts.

Bit-Inserts, Drive hex 10 mm; Length 30 mm

Part-No.	Size	Part-No.	Size
KL-4044-7020	T20	KL-4044-7045	T45
KL-4044-7025	T25	KL-4044-7050	T50
KL-4044-7030	T30	KL-4044-7055	T55
KL-4044-7040	T40		

Bit-Inserts, Drive hex 10 mm; Length 75 mm

Part-No.	Size	Part-No.	Size
KL-4044-7120	Torx® T20	KL-4044-7145	Torx® T45
KL-4044-7125	Torx® T25	KL-4044-7150	Torx® T50
KL-4044-7130	Torx® T30	KL-4044-7155	Torx® T55
KL-4044-7140	Torx® T40		

Sockets, Drive 1/4"□, Length 23 mm

Part-No.	Size	Part-No.	Size
KL-4047-6004	Torx® E4	KL-4047-6007	Torx® E7
KL-4047-6005	Torx® E5	KL-4047-6008	Torx® E8
KL-4047-6006	Torx® E6		

Sockets, Drive 3/8"□, Length 23 mm

Part-No.:	Size	Part-No.	Size
KL-4047-2010	Torx® E10	KL-4047-2012	Torx® E12
KL-4047-2011	Torx® E11	KL-4047-2014	Torx® E14

Sockets, Drive 1/2"□, Length 40 mm

Part-No.	Size	Part-No.	Size
KL-4045-3516	Torx® E16	KL-4045-3522	Torx® E22
KL-4045-3518	Torx® E18	KL-4045-3524	Torx® E24
KL-4045-3520	Torx® E20		

Plastic case KL-4044-7099 (empty) for KL-4044-701 K.

® = reg. trademark of Camcar-Textron Inc. USA

KL-4054-701 K Socket Insert Set RIBE®

Consists of:

KL-4004-229 Bit-Holder, ⌀ hex 10 mm; Drive 3/8"□ carrier for the screwdriver Inserts

KL-4004-329 Bit-Holder, ⌀ hex 10 mm; Drive 1/2"□ carrier for the screwdriver Inserts

Bit-Inserts, Drive hex 10 mm; Length 30 mm

Part-No.	Size	Part-No.	Size
KL-4054-7004	M 4	KL-4054-7009	M 9
KL-4054-7005	M 5	KL-4054-7010	M 10
KL-4054-7006	M 6	KL-4054-7012	M 12
KL-4054-7007	M 7	KL-4054-7013	M 13
KL-4054-7008	M 8	KL-4054-7014	M 14

Bit-Inserts, Drive hex 10 mm; Length 75 mm

Part-No.	Size	Part-No.	Size
KL-4054-7104	M 4	KL-4054-7109	M 9
KL-4054-7105	M 5	KL-4054-7110	M 10
KL-4054-7106	M 6	KL-4054-7112	M 12
KL-4054-7107	M 7	KL-4054-7113	M 13
KL-4054-7108	M 8	KL-4054-7114	M 14

Plastic case KL-4054-7099 (empty) for KL-4054-701 K.

® = reg. trademark of Richard Bergner GmbH & Co. KG

KL-4004-100 K

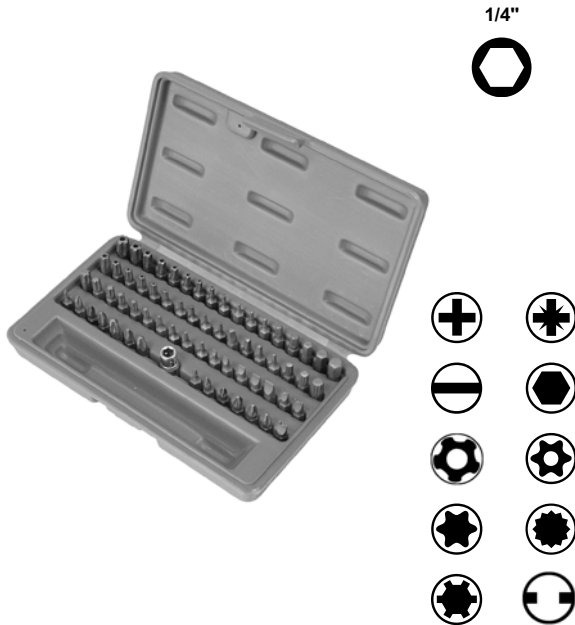

KL-4004-100 K Bit Insert Set 62 pcs.

Consists of:

Bit-Holder. 1/4" ; Drive 1/4" insert holder.

Bit-Inserts:

- Phillips (PH) Size:0; 1 (2 Pcs.); 2 (3 Pcs.); 3;
- Pozidriv (PZ) Size:0; 1 (2 Pcs.); 2 (2 Pcs.); 3;
- Straight Size: 3; 4; 4,5; 5,5; 6,5;
- Hex. Size: 2; 2,5; 3;4; 5; 6; 7; 8;
- 5-Point Size: T-10; T-15; T-20; T-25; T-27; T-30; T-40; T-45; T-50;
- RIBE® Size: M4; M5; M6; M7
- Torx® Size: 7; 8; 9; 10; 15; 20; 25; 27; 30; 40;
- Torx® Size: 7; 8; 9; 10; 15; 20; 25; 27; 30; 40;
- XZN Size: 5; 6; 8;
- Spanner Size: 6; 8; 10

Plastic case

KL-4004-111



KL-4004-111 Bit-Driver, angled 1/4" and 5/16" with retaining magnet

Reversible for Left or Right rotation. With Drives for 5/16" and 1/4" Bit Inserts. Each Bit-Drive has a knurled thumb-wheel for rapid insertion of bolts before final tightening. The Bit-Inserts are retained in the drive by a built-in magnet. Especially useful for difficult accessible places.

Technical Data:

Weight: 120 g
 Length: 132 mm
 Bit- Drive: 1/4"
 Bit- Drive: 5/16"

KL-4004-112



KL-4004-112 Bit-Driver, straight 1/4" and 5/16" with retaining magnet

Reversible for Left or Right rotation. With Drives for 5/16" and 1/4" Bit Inserts. Each Bit-Drive has a knurled thumb-wheel for rapid insertion of bolts before final tightening. The Bit-Inserts are retained in the drive by a built-in magnet. Especially useful for difficult accessible places.

Technical Data:

Weight: 120 g
 Length: 140 mm
 Bit- Drive: 1/4"
 Bit- Drive: 5/16"

KL-4004-120



1/4"

KL-4004-120 Flexible Bit Holder with flexible extension, 1/4"

Especially useful for difficult accessible places.

Length Screw Driver : 375 mm
 Length Extension : 135 mm
 Bit- Drive: 1/4"
 Weight: 250 g

KL-4004-130



1/4"

KL-4004-130 Bit Holder 1/4"

With Drives for 1/4" Bit Inserts.

The Bit-Inserts are retained in the drive by a built-in magnet.

Length: 210 mm
 Bit- Drive: 1/4"
 Weight: 100 g

KL-4061-101

Mercedes (Atego, Actros)



Five point

VW-Audi,
Rover 75, MG ZT

KL-4061-101 Socket Insert Set (Five point), 1/4"

Chrome Vanadium Steel

KL-4061-101 Socket Insert Set

consists of:

Part-No.	Five point	L1 [mm]	L2 [mm]	Weight [g]
KL-4061-1010	10	9	25	5
KL-4061-1015	15	9	25	5
KL-4061-1020	20	9	25	5
KL-4061-1025	25	9	25	5
KL-4061-1027	27	9	25	5
KL-4061-1030	30	9	25	5
KL-4061-1040	40	9	25	5
KL-4061-101 L	Storage Rail 1/4"			

KL-4064-601 K

VW-Audi, Mercedes,
Rover, MG



Five point

VW-Audi airflow meters.



Pumps for pump-line-injector systems on Mercedes commercial vehicles.



KL-4064-601 K Socket Insert Set (Five point)

9 screwdriver inserts in plastic case.

Suitable e.g. for:

- VW-Audi airflow meter.
- Mercedes outside mirror.
- Immobiliser control unit (EWS3) on Rover 75 and MG ZT.
- Pumps in pump-line-injector systems on Mercedes commercial vehicles (e.g. Atego, Actros).

For loosening and tightening the new five-point tamper-proof bolts with bore.

Consists of:

- 9x Bit Insert, Drive hex. 1/4".
- 1x Bit-holder, Hex. 1/4"; Drive 1/4" (to insert the screwdriver bits)
- 1x Plastic case

- Total weight: 100 g
- Size: 10, 15, 20, 25, 27, 30, 40, 45, 50
- Drive (Insert): hex. 1/4"
- Drive (Bit Holder): 1/4"
- Length (Insert): 25 mm
- Dimension (Plastic case) 114 x 53 x 21 mm

KL-4031-300 K



KL-4031-30.. (1/2"□, 55 mm) KL-4031-31.. (1/2"□, 100 mm)



KL-4031-33.. (1/2"□, 140 mm)



KL-4031-34.. (1/2"□, 200 mm)



KL-0232-1

Extra long

VW-Audi

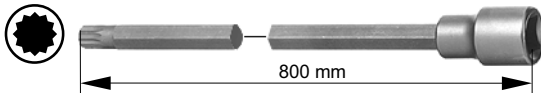

KL-0232-2

Extra long

VW-Audi

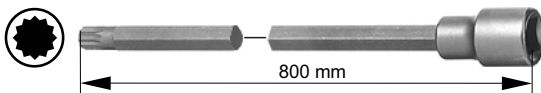

KL-0232-3

Extra long

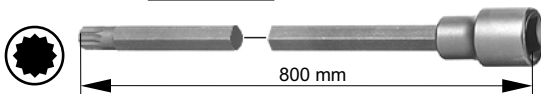

KL-0232-4

Extra long

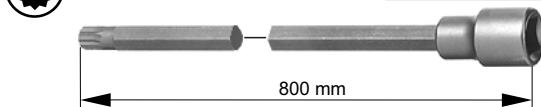
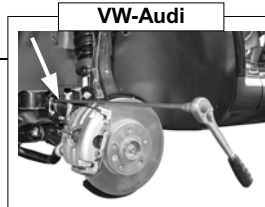

KL-0231-2

VW-Audi



Oil Drain Plug

KL-4031-300 K Socket Insert Set

Drive 1/2", XZN, 26 Pcs.

Consists of:

Socket Inserts, Drive 1/2"□, Length 55 mm

Part-No.	Size	Part-No.	Size
KL-4031-3005	M5	KL-4031-3010	M10
KL-4031-3006	M6	KL-4031-3012	M12
KL-4031-3008	M8	KL-4031-3014	M14
KL-4031-3009	M9	KL-4031-3016	M16

Socket Inserts, Drive 1/2"□, Length 100 mm

Part-No.	Size	Part-No.	Size
KL-4031-3105	M5	KL-4031-3110	M10
KL-4031-3106	M6	KL-4031-3112	M12
KL-4031-3108	M8	KL-4031-3114	M14
KL-4031-3109	M9		

Socket Inserts, Drive 1/2"□, Length 140 mm

Part-No.	Size	Part-No.	Size
KL-4031-3305	M5	KL-4031-3310	M10
KL-4031-3306	M6	KL-4031-3312	M12
KL-4031-3308	M8	KL-4031-3314	M14
KL-4031-3309	M9		

Socket Inserts, Drive 1/2"□, Length 200 mm

Part-No.	Size	Part-No.	Size
KL-4031-3408	M8	KL-4031-3412	M12
KL-4031-3410	M10	KL-4031-3414	M14

KL-4031-3099 Plastic case (empty) for KL-4031-300 K.

KL-0232-1 Socket Insert xZN M8

For loosening the screws at the drive shaft quick and easy from outside → Increased job time saving.

Not permitted for the use of impact guns.

Application: **VW-Audi**, etc.

Length: 800 mm Drive: 1/2"□

KL-0232-2 Socket Insert xZN M10

Application as **KL-0232-1**.

Especially for **VW Golf IV** etc.

Length: 800 mm Drive: 1/2"□

KL-0232-3 Socket Insert xZN M12

Application as **KL-0232-1**.

Especially for **VW T4, Touareg** etc.

Length: 800 mm Drive: 1/2"□

KL-0232-4 Socket Insert xZN M14

Application as **KL-0232-1**.

Especially for **VW T4, Touareg** etc.

Length: 800 mm Drive: 1/2"□

KL-0231-2 Special Socket Insert xZN M16

For removal and replacement of the Gear Box drain plug.

Application: **Audi A3, A4, A6; VW Golf IV, LT**.

Length: 60 mm Drive: 1/2"□

KL-4051-300 K



KL-4051-30.. (1/2"□, 55 mm) KL-4051-31.. (1/2"□, 100 mm)



KL-4051-33.. (1/2"□, 140 mm)



KL-4051-34.. (1/2"□, 200 mm)



KL-4051-331 A

Fiat

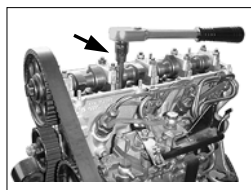

KL-4051-3310

VW-Audi



KL-4051-300 K Socket Insert Set Drive 1/2", RIBE®, 32 pcs.

Consists of:

Socket Inserts, Drive 1/2"□, Length 55 mm

Part-No.	Size	Part-No.	Size
KL-4051-3005	M5	KL-4051-3010	M10
KL-4051-3006	M6	KL-4051-3012	M12
KL-4051-3007	M7	KL-4051-3013	M13
KL-4051-3008	M8	KL-4051-3014	M14
KL-4051-3009	M9		

Socket Inserts, Drive 1/2"□, Length 100 mm

Part-No.	Size	Part-No.	Size
KL-4051-3105	M5	KL-4051-3110	M10
KL-4051-3106	M6	KL-4051-3112	M12
KL-4051-3107	M7	KL-4051-3113	M13
KL-4051-3108	M8	KL-4051-3114	M14
KL-4051-3109	M9		

Socket Inserts, Drive 1/2"□, Length 140 mm

Part-No.	Size	Part-No.	Size
KL-4051-3308	M8	KL-4051-3312	M12
KL-4051-3309	M9	KL-4051-3313	M13 (FIAT)
KL-4051-3310	M10 (VW)	KL-4051-3314	M14
KL-4051-3311	M10 (FIAT)		

Socket Inserts, Drive 1/2"□, Length 200 mm

Part-No.	Size	Part-No.	Size
KL-4051-3408	M8	KL-4051-3412	M12
KL-4051-3409	M9	KL-4051-3413	M13 (FIAT)
KL-4051-3410	M10 (VW)	KL-4051-3414	M14
KL-4051-3411	M10 (FIAT)		

KL-4051-3099 Plastic case (empty) for KL-4051-300 K.

KL-4051-331 A Socket Insert Set- Drive 1/2", RIBE®

To remove and re-tighten cylinder-head retaining bolts e.g. on Fiat engines with RIBE-profile.

Socket Inserts, Drive 1/2"□, Length 55 mm

Part-No.	Size	Part-No.	Size
KL-4051-3007	M7	KL-4051-3008	M8

Socket Inserts, Drive 1/2"□, Length 140 mm

Part-No.	Size	Part-No.	Size
KL-4051-3311	M10 (FIAT)	KL-4051-3313	M13 (FIAT)
KL-4051-3312	M12	KL-4051-3314	M14

KL-4051-3310 Socket Insert RIBE® M10 1/2" (length 140 mm)

Ideal to remove and re-tighten cylinder-head retaining bolts on VW-Audi engines with RIBE similar profile.

Drive: 1/2"□ Length: 140 mm

® = reg. trademark of Richard Bergner GmbH & Co. KG

KL-4041-361 K



KL-4041-361 K Socket Insert Set Torx®

Strong sockets complete with plastic box. Application for repairs on axles and engines.

Socket Inserts, Drive 1/2"□, Length 78 mm

Part-No.	Size	Part-No.	Size
KL-4041-3630	T30	KL-4041-3655	T55
KL-4041-3640	T40	KL-4041-3660	T60
KL-4041-3645	T45	KL-4041-3670	T70
KL-4041-3650	T50		

KL-4041-300 K



KL-4041-300 K Socket Insert Set Drive 1/2", Torx®, 32 pcs.

Consists of:

Socket Inserts, Drive 1/2"□, Length 55 mm

Part-No.	Size	Part-No.	Size
KL-4041-3020	T20	KL-4041-3045	T45
KL-4041-3025	T25	KL-4041-3050	T50
KL-4041-3027	T27	KL-4041-3055	T55
KL-4041-3030	T30	KL-4041-3060	T60
KL-4041-3040	T40	KL-4041-3070	T70

Socket Inserts, Drive 1/2"□, Length 100 mm

Part-No.	Size	Part-No.	Size
KL-4041-3120	T20	KL-4041-3145	T45
KL-4041-3125	T25	KL-4041-3150	T50
KL-4041-3127	T27	KL-4041-3155	T55
KL-4041-3130	T30	KL-4041-3160	T60
KL-4041-3140	T40	KL-4041-3170	T70

Socket Inserts, Drive 1/2"□, Length 140 mm

Part-No.	Size	Part-No.	Size
KL-4041-3340	T40	KL-4041-3355	T55
KL-4041-3345	T45	KL-4041-3360	T60
KL-4041-3350	T50	KL-4041-3370	T70

Socket Inserts, Drive 1/2"□, Length 200 mm

Part-No.	Size	Part-No.	Size
KL-4041-3440	T40	KL-4041-3455	T55
KL-4041-3445	T45	KL-4041-3460	T60
KL-4041-3450	T50	KL-4041-3470	T70

KL-4041-3099 Plastic case (empty) for KL-4041-300 K.

KL-4041-30.. (1/2"□, 55 mm) KL-4041-31.. (1/2"□, 100 mm)



KL-4041-33.. (1/2"□, 140 mm)



KL-4041-34.. (1/2"□, 200 mm)



© = reg. trademark of Camar-Textron Inc. USA

KL-4041-33..



KL-4045-33..



KL-4041-33.. Socket Inserts

Chrome-vanadium-Steel. Drive: 1/2" □

Part-No.	Torx®	L1 [mm]	L2 [mm]	Weight [g]
KL-4041-3380	T80	100	140	250
KL-4041-3390	T90	100	140	270
KL-4041-3391	T100	100	140	300

KL-4045-33.. Socket Inserts

Chrome-vanadium-Steel. Drive: 1/2" □

Part-No.	Torx®	L1 [mm]	L2 [mm]	Weight [g]
KL-4045-3380	T80	100	140	250
KL-4045-3390	T90	100	140	270
KL-4045-3391	T100	100	140	300

KL-4041-302 K



KL-4041-30.. (1/2"□, 55 mm) KL-4021-30.. (1/2"□, 55 mm)



KL-4045-312 K



1/2"



KL-4041-140



1/4"



KL-4041-240



3/8"



KL-4041-302 K Socket Insert Set

Drive 1/2", Torx® / Hex

Socket Inserts, Drive: 1/2"□, Length: 55 mm

Part-No.	Size	Part-No.	Size
KL-4041-3030	T30	KL-4041-3055	T55
KL-4041-3040	T40	KL-4041-3060	T60
KL-4041-3045	T45	KL-4041-3070	T70
KL-4041-3050	T50		

Socket Inserts, Drive: 1/2"□, Length: 55 mm

Part-No.	Size	Part-No.	Size
KL-4021-3005	M5	KL-4021-3010	M10
KL-4021-3006	M6	KL-4021-3012	M12
KL-4021-3007	M7	KL-4021-3014	M14
KL-4021-3008	M8		

© = reg. trademark of Camcar-Textron Inc. USA

KL-4045-312 K Socket Insert Set Torx®

Set of Torx® Sockets in extended length for tamper-proof bolts Torx® with pilot.

Socket Inserts, Drive: 1/2"□, Length: 100 mm

Part-No.	Size	Part-No.	Size
KL-4045-3130	T30	KL-4045-3155	T55
KL-4045-3140	T40	KL-4045-3160	T60
KL-4045-3145	T45	KL-4045-3170	T70
KL-4045-3150	T50		

KL-4041-140 Socket Insert Set

Drive 1/4", Torx®

Socket Inserts, Drive: 1/4"□, Length: 200 mm

Part-No.	Size	Part-No.	Size
KL-4041-1407	T7	KL-4041-1420	T20
KL-4041-1408	T8	KL-4041-1425	T25
KL-4041-1409	T9	KL-4041-1427	T27
KL-4041-1410	T10	KL-4041-1430	T30
KL-4041-1415	T15	KL-4041-1440	T40

Chrome-vanadium-Steel.

KL-4041-240 Socket Insert Set

Drive 3/8", Torx®

Socket Inserts, Drive: 3/8"□, Length: 200 mm

Part-No.	Size	Part-No.	Size
KL-4041-2410	T10	KL-4041-2430	T30
KL-4041-2415	T15	KL-4041-2440	T40
KL-4041-2420	T20	KL-4041-2445	T45
KL-4041-2425	T25	KL-4041-2450	T50
KL-4041-2427	T27	KL-4041-2455	T55

Chrome-vanadium-Steel.

KL-4046-220 K



1/4" 3/8"



KL-4047-61.. (1/4"□, 50 mm) KL-4047-21.. (3/8"□, 55 mm)



KL-4047-61.. (1/4"□, 50 mm)



KL-4047-140



1/4"



KL-4047-240



3/8"



KL-4046-362

BMW, Mercedes

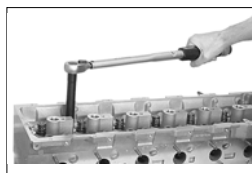

KL-4046-220 K Socket Set Drive 1/4" / 3/8", Torx®

Extra long and slim design.

Sockets, Drive 1/4"□, Length 50 mm

Part-No.	Size	Part-No.	Size
KL-4047-6104	E4	KL-4047-6107	E7
KL-4047-6105	E5	KL-4047-6108	E8
KL-4047-6106	E6	KL-4047-6110	E10

Sockets, Drive 3/8"□, Length 55 mm

Part-No.	Size	Part-No.	Size
KL-4047-2111	E11	KL-4047-2116	E16
KL-4047-2112	E12	KL-4047-2118	E18
KL-4047-2114	E14		

KL-4004-329 Reducer 3/8" to 1/4" Length 26,5 mm

KL-4046-2299 Plastic case (empty) for KL-4026-220 K

KL-4047-140 Socket Set Torx® 1/4"

Sockets, Drive 1/4"□, Length 200 mm

Part-No.	Size	Part-No.	Size
KL-4047-1404	E4	KL-4047-1407	E7
KL-4047-1405	E5	KL-4047-1408	E8
KL-4047-1406	E6	KL-4047-1410	E10

Chrome-vanadium-Steel.

KL-4047-240 Socket Set-Torx® 3/8"

Sockets, Drive 3/8"□, Length 200 mm

Part-No.	Size	Part-No.	Size
KL-4047-2406	E6	KL-4047-2410	E10
KL-4047-2407	E7	KL-4047-2411	E11
KL-4047-2408	E8	KL-4047-2412	E12

Chrome-vanadium-Steel.

® = reg. trademark of Camcar-Textron Inc. USA

KL-4046-362 Socket Set Torx® (4 Pcs.)

These Torx® Sockets in extended length with built-in magnet allow quick and easy removal and replacement of cylinder-head bolts with outer-Torx® profiles. (e.g. **BMW, Mercedes CDI engines, etc.**)

Sockets, Drive 1/2"□, Length 150 mm

Part-No.	Size	Part-No.	Size
KL-4046-3610	E10	KL-4046-3614	E14
KL-4046-3612	E12	KL-4046-3618	E18

KL-4041-302 K



KL-4041-30.. (1/2"□, 55 mm) KL-4021-30.. (1/2"□, 55 mm)

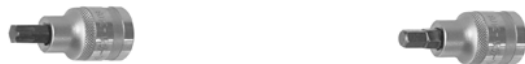

KL-4022-241

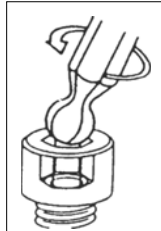
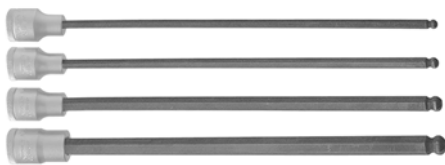

KL-4021-300 K



KL-4021-30.. (1/2"□, 55 mm) KL-4021-31.. (1/2"□, 100 mm)



KL-4021-33.. (1/2"□, 140 mm)



KL-4021-34.. (1/2"□, 200 mm)

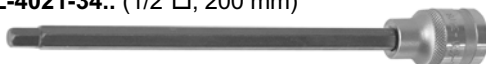

KL-4041-302 K Socket Insert Set

Drive 1/2", Torx® / Hex

Socket Inserts, Drive 1/2"□, Length 55 mm

Part-No.	Size	Part-No.	Size
KL-4041-3030	T30	KL-4041-3055	T55
KL-4041-3040	T40	KL-4041-3060	T60
KL-4041-3045	T45	KL-4041-3070	T70
KL-4041-3050	T50		

Socket Inserts, Drive 1/2"□, Length 55 mm

Part-No.	Size	Part-No.	Size
KL-4021-3005	hex 5 mm	KL-4021-3010	hex 10 mm
KL-4021-3006	hex 6 mm	KL-4021-3012	hex 12 mm
KL-4021-3007	hex 7 mm	KL-4021-3014	hex 14 mm
KL-4021-3008	hex 8 mm		

© = reg. trademark of Camcar-Textron Inc. USA

KL-4022-241 Socket Insert Set

"Ball head"

Extra-long design with ball head.

Ideal for unscrewing and tightening internal socket screws that sit very deep or are hard to access.

Socket Inserts, Drive 1/2"□, Length 288 mm

Part-No.	Size	Part-No.	Size
KL-4022-2405	hex 5 mm	KL-4022-2408	hex 8 mm
KL-4022-2406	hex 6 mm	KL-4022-2410	hex 10 mm

Application examples:

KL-4022-2405 For oil sump bolts in

VW T4 5-cylinder engines;

KL-4022-2408 Removal and installation of knock sensor on Audi V6 engines

KL-4021-300 K Socket Insert Set

Drive 1/2", Hex, 30 pcs.

Socket Inserts, Drive 1/2"□, Length 55 mm

Part-No.	Size	Part-No.	Size
KL-4021-3005	5 mm	KL-4021-3012	12 mm
KL-4021-3006	6 mm	KL-4021-3014	14 mm
KL-4021-3007	7 mm	KL-4021-3017	17 mm
KL-4021-3008	8 mm	KL-4021-3019	19 mm
KL-4021-3010	10 mm		

Socket Inserts, Drive 1/2"□, Length 100 mm

Part-No.	Size	Part-No.	Size
KL-4021-3105	5 mm	KL-4021-3110	10 mm
KL-4021-3106	6 mm	KL-4021-3111	11 mm
KL-4021-3107	7 mm	KL-4021-3112	12 mm
KL-4021-3108	8 mm	KL-4021-3113	13 mm

Socket Inserts, Drive 1/2"□, Length 140 mm

Part-No.	Size	Part-No.	Size
KL-4021-3305	5 mm	KL-4021-3310	10 mm
KL-4021-3306	6 mm	KL-4021-3312	12 mm
KL-4021-3307	7 mm	KL-4021-3314	14 mm
KL-4021-3308	8 mm		

Socket Inserts, Drive 1/2"□, Length 200 mm

Part-No.	Size	Part-No.	Size
KL-4021-3405	5 mm	KL-4021-3408	8 mm
KL-4021-3406	6 mm	KL-4021-3410	10 mm
KL-4021-3407	7 mm	KL-4021-3412	12 mm

KL-4021-3099 Plastic case (empty) for KL-4021-300 K

KL-4011-281 K



KL-0369-91



Mercedes CDI,
Opel CDTI,
Fiat/Lancia JTD

Glow Plug



Opel CDTI,
Fiat JTD

KL-0369-92

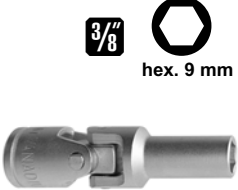

KL-0369-14



KL-0369-9



KL-0369-7



KL-0369-12



KL-0127-42



KL-4011-281 K Jointed Socket Set

With Special 6-point Flank-Drive Profile.

Jointed Sockets, Drive 3/8"□, Length 55 mm

Part-No.	hex	Part-No.	hex
KL-4011-2810	10 mm	KL-4011-2815	15 mm
KL-4011-2811	11 mm	KL-4011-2816	16 mm
KL-4011-2812	12 mm	KL-4011-2817	17 mm
KL-4011-2813	13 mm	KL-4011-2818	18 mm
KL-4011-2814	14 mm	KL-4011-2819	19 mm

KL-4011-2890 Plastic case (empty) for KL-4011-281 K.

KL-0369-91 Jointed Glow Plug Socket 8 mm

With built-in O-ring.

Especially designed for easy removal and replacement of glow plugs.

Length:..... 75 mm Hex.:..... 8 mm
Drive:..... 3/8"□ Weight:..... 90 g

Suitable for:

- Mercedes CDI engines OM 640 and OM 642 e.g. A-Class (2004-onwards) [W169], B-Class [W245] etc.
- Opel 1,3 L CDTI engines e.g. Agila, Corsa C etc.
- Fiat 1,3 L JTD engine e.g. Doblo, Idea, Punto etc.
- Lancia 1,3 L JTD e.g. Ypsilon etc.

KL-0369-92 Jointed Socket Glow Plugs 9 mm

With built-in O-ring.

Length:..... 75 mm Hex.:..... 9 mm
Drive:..... 3/8"□ Weight:..... 90 g

Suitable for:

- Opel 1,9 L CDTI engines e.g. Astra H, Signum, Vectra C etc.
- Fiat 1,9 L JTD 1,6V engine e.g. Stilo etc.

KL-0369-14 Jointed Socket Glow Plugs 10 mm

With built-in retaining spring or O-ring

Designed especially for easy removal and replacement of glow plugs.

Application: **Mercedes CDI-Engines (OM611, 612, 613)**

Hex.:..... 10 mm Drive:..... 3/8"□
Length:..... 70 mm

KL-0369-9 Jointed Glow Plug Socket 10 mm

With built-in retaining spring or O-ring.

Designed especially for easy removal and replacement of glow plugs.

Hex.:..... 10 mm Drive:..... 3/8"□
Length:..... 65 mm

KL-0369-7 Jointed Glow Plug Socket 12 mm

With built-in retaining spring or O-ring

Designed especially for easy removal and replacement of glow plugs.

Hex.:..... 12 mm Drive:..... 3/8"□
Length:..... 65 mm

KL-0369-12 Jointed Glow Plug Socket 12 mm

With built-in retaining spring or O-ring.

Designed especially for easy removal and replacement of glow plugs.

Hex.:..... 12 mm Drive:..... 3/8"□
Length:..... 70 mm

KL-0127-42 Jointed Spark-Plug Socket 14 mm

Length:..... 80 mm Hex.:..... 14 mm
Drive:..... 3/8"□ Weight:..... 100 g

KL-0127-41



KL-0127-41 Spark-Plug Socket

Suitable for Renault Clio 1,2 16V; Twingo 1,2 16V etc.

Length: 230 mm
 Hex.: hex. 14 mm
 Drive: 3/8"

KL-0127-43



KL-0127-43 Spark-Plug Socket

Suitable for Citroën C5 HPI, Peugeot 406 HPI, Mini One etc.

Length: 90 mm
 Size: bihex. 14 mm
 Drive: 3/8"

KL-0127-44



KL-0127-44 Spark-Plug Socket

Suitable for Citroën C5 HPI, Peugeot 406 HPI, Mini One etc.

Length: 250 mm
 Size: bihex. 14 mm
 Drive: 3/8"

KL-0127-45



KL-0127-45 Spark-Plug Socket

Length: 90 mm
 Size: hex. 16 mm
 Drive: 3/8"

KL-0127-46



KL-0127-46 Spark-Plug Socket

Length: 250 mm
 Size: hex. 16 mm
 Drive: 3/8"

KL-4015-2016



KL-4015-2016 Spark-Plug Socket Insert

Length: 65 mm
 Hex.: hex. 16 mm
 Drive: 3/8"

KL-4015-2021



KL-4015-2021 Spark-Plug Socket Insert

Length: 65 mm
 Hex.: hex. 21 mm
 Drive: 3/8"

KL-4015-3016



KL-4015-3016 Spark-Plug Socket Insert

Length: 65 mm
 Hex.: hex. 16 mm
 Drive: 1/2"

KL-4015-3021



KL-4015-3021 Spark-Plug Socket Insert

Length: 65 mm
 Hex.: hex. 21 mm
 Drive: 1/2"

KL-0100-6

1/2"

3/8"



KL-4007-311



1/2"

Spare Part: KL-4007-3112 Hinged Head



KL-0015-0050-K



KL-0040-0050-K



KL-0043-85



KL-0100-6 Extension Length 600 mm

This tool is essential for works on gearbox, engine and on the exhaust system.

Drive: 1/2" □ to 3/8" ■

KL-4007-311 Breaker Bar 1/2" Length 620 mm

Extra long version with 180° joint.
Useable for extremely stubborn fastenings.

Technical Data:

Length total.: 620 mm
Drive: 1/2" □

Spare Part: KL-4007-3112 Hinged Head

KL-0015-0050 Wooden Storage Tray (empty)

To store Spring Compressors KL-0013, KL-0015 or KL-2000 with Jaws KL-1500-SP, KL-1510-SP, KL-1520-SP and KL-1561 as well as the Adaptor KL-1590-1.

KL-0015-0050-K Wooden Storage Tray complete with Tools

consists of:

Part No.	Description	Part No.	Description
KL-0015-100	Compressor Cylinder	KL-1520-SP	Jaws size 2 with Protective Inserts
KL-1500-SP	Jaws size 0 with Protective Inserts	KL-1561	Jaw size 6
KL-1510-SP	Jaws size 1 with Protective Inserts	KL-1590-1	Adaptor
		KL-0015-0050	Storage Tray empty

KL-0040-0050 Wooden Storage Tray (empty)

To store the Bearing Puller Tool Sets KL-0040-3, KL-0040-5 or KL-0040-6 with the Press Tool KL-0041-3 and the Hydraulic Cylinder KL-0040-25.

KL-0040-0050-K Wooden Storage Tray complete with Tools

consists of:

Part No.	Description	Part No.	Description
KL-0040-5	Bearing Puller for Europ. & Jap. cars	KL-0041-3	Press Tool
KL-0040-25	Hydraulic Cylinder	KL-0040-0050	Storage Tray empty

KL-0043-8550 Wooden Storage Tray (empty)

To store the Hydraulic Press Tool Kits, KL-0043-821, KL-0043-822, KL-0043-823, KL-0043-851, KL-0043-852, KL-0043-853 or KL-0043-854.

KL-0043-85 Press Tool with hydr. Cyl. (17 t.) (short version)

consists of:

Part No.	Description	Part No.	Description
KL-0215-10	Hydraulic Cylinder 17 t	KL-0043-8295	Press Tube Set (Ø 26 - 68 mm)
KL-0043-8510	Press Frame short	KL-0043-8595	Press Tube Set short (Ø 26 - 68 mm)
KL-0043-8206	Adaptor	KL-0043-8550	Storage Tray empty
KL-0043-8208	Rubber Ring		

10

Plastic case



KL-4990-1004



KL-4990-1007



KL-4990-1017

KL-4999-100



Universal-plastic case with foamed material liner.

KL-4990-1004 Plastic case

Measurement:

outside: 275x230x83 mm (WxHxD)

inside: 261x175x77 mm (WxHxD)

KL-4990-1007 Plastic case

Measurement:

outside: 340x275x83 mm (WxHxD)

inside: 326x222x77 mm (WxHxD)

KL-4990-1017 Plastic case

Measurement:

outside: 450x360x106 mm (WxHxD)

inside: 437x295x100 mm (WxHxD)

KL-4999-100 Workshop trolley with 7 Drawers

Sturdy and mobile workstation. Drawers are provided with single-locking device and central closure. Solid copper beech board spray-glued, large mobile frame with robust sliding wheels with double brake.

Technical Data:

Weight: 125 kg
 Dimensions: W 1310 x H 925 x D 600 mm
 Worktop: W 1200 x H 25 x D 600 mm
 Drawers (1x) W 1035 x H 180 mm
 Drawers (2x) W 490 x H 135 mm
 Drawers (4x) W 490 x H 180 mm
 Castors with brakes (2x): Ø 125 mm
 Fixed roller (2x): Ø 125 mm